

PHYSICS

PART – I

TEXTBOOK FOR CLASS XII



12089



राष्ट्रीय शैक्षिक अनुसंधान और प्रशिक्षण परिषद्
NATIONAL COUNCIL OF EDUCATIONAL RESEARCH AND TRAINING

downloaded from stateboard.co.in

2024-25

12089 – PHYSICS PART I

Textbook for Class XII

ISBN 81-7450-631-4

First Edition

December 2006 Pausa 1928

Reprinted

December 2007, December 2008,
December 2009, January 2011,
January 2012, November 2012,
November 2013, December 2014,
December 2015, February 2017,
January 2018, January 2019,
October 2019, August 2021 and
December 2021

Revised Edition

November 2022 Agrahayana 1944

Reprinted

March 2024 Chaitra 1946

PD 325T SU

© National Council of Educational
Research and Training, 2006, 2022

₹ 200.00

Printed on 80 GSM paper with NCERT
watermark

Published at the Publication Division by the
Secretary, National Council of Educational
Research and Training, Sri Aurobindo Marg,
New Delhi 110 016 and printed at Eye Vision
Printograph, 78, Mohkampur Industrial
Complex, Phase-I, Delhi Road, Meerut - 250 002
(U.P.)

ALL RIGHTS RESERVED

- No part of this publication may be reproduced, stored in a retrieval system or transmitted, in any form or by any means, electronic, mechanical, photocopying, recording or otherwise without the prior permission of the publisher.
- This book is sold subject to the condition that it shall not, by way of trade, be lent, re-sold, hired out or otherwise disposed of without the publisher's consent, in any form of binding or cover other than that in which it is published.
- The correct price of this publication is the price printed on this page. Any revised price indicated by a rubber stamp or by a sticker or by any other means is incorrect and should be unacceptable.

OFFICES OF THE PUBLICATION DIVISION, NCERT

NCERT Campus
Sri Aurobindo Marg
New Delhi 110 016 Phone : 011-26562708

108, 100 Feet Road
Hosdakere Halli Extension
Banashankari III Stage
Bengaluru 560 085 Phone : 080-26725740

Navjivan Trust Building
P.O. Navjivan
Ahmedabad 380 014 Phone : 079-27541446

CWC Campus
Opp. Dhankal Bus Stop
Panihati
Kolkata 700 114 Phone : 033-25530454

CWC Complex
Maligaon
Guwahati 781 021 Phone : 0361-2674869

Publication Team

Head, Publication Division : Anup Kumar Rajput
Chief Editor : Shveta Uppal
Chief Production Officer : Arun Chitkara
Chief Business Manager (In charge) : Amitabh Kumar
Assistant Editor : R.N. Bhardwaj
Assistant Production Officer : Sunil Kumar

Cover, Layout and Illustrations
Shweta Rao

FOREWORD

The National Curriculum Framework (NCF), 2005 recommends that children's life at school must be linked to their life outside the school. This principle marks a departure from the legacy of bookish learning which continues to shape our system and causes a gap between the school, home and community. The syllabi and textbooks developed on the basis of NCF signify an attempt to implement this basic idea. They also attempt to discourage rote learning and the maintenance of sharp boundaries between different subject areas. We hope these measures will take us significantly further in the direction of a child-centred system of education outlined in the National Policy on Education (NPE), 1986.

The success of this effort depends on the steps that school principals and teachers will take to encourage children to reflect on their own learning and to pursue imaginative activities and questions. We must recognise that, given space, time and freedom, children generate new knowledge by engaging with the information passed on to them by adults. Treating the prescribed textbook as the sole basis of examination is one of the key reasons why other resources and sites of learning are ignored. Inculcating creativity and initiative is possible if we perceive and treat children as participants in learning, not as receivers of a fixed body of knowledge.

These aims imply considerable change in school routines and mode of functioning. Flexibility in the daily time-table is as necessary as rigour in implementing the annual calendar so that the required number of teaching days are actually devoted to teaching. The methods used for teaching and evaluation will also determine how effective this textbook proves for making children's life at school a happy experience, rather than a source of stress or boredom. Syllabus designers have tried to address the problem of curricular burden by restructuring and reorienting knowledge at different stages with greater consideration for child psychology and the time available for teaching. The textbook attempts to enhance this endeavour by giving higher priority and space to opportunities for contemplation and wondering, discussion in small groups, and activities requiring hands-on experience.

The National Council of Educational Research and Training (NCERT) appreciates the hard work done by the textbook development committee responsible for this book. We wish to thank the Chairperson of the advisory group in science and mathematics, Professor J.V. Narlikar and the Chief Advisor for this book, Professor A.W. Joshi for guiding the work of this committee. Several teachers contributed to the development of this textbook; we are grateful to their principals for making this possible. We are indebted to the institutions and organisations which have generously permitted us to draw upon their resources, material and personnel. We are especially grateful to the members of the National Monitoring Committee, appointed by the Department of Secondary and Higher Education, Ministry of Human Resource Development under the Chairpersonship of Professor Mrinal Miri and Professor G.P. Deshpande, for their valuable time and contribution. As an organisation committed to systemic reform and continuous improvement in the quality of its products, NCERT welcomes comments and suggestions which will enable us to undertake further revision and refinement.

New Delhi
20 December 2006

Director
National Council of Educational
Research and Training

© NCERT
not to be republished

RATIONALISATION OF CONTENT IN THE TEXTBOOKS

In view of the COVID-19 pandemic, it is imperative to reduce content load on students. The National Education Policy 2020, also emphasises reducing the content load and providing opportunities for experiential learning with creative mindset. In this background, the NCERT has undertaken the exercise to rationalise the textbooks across all classes. Learning Outcomes already developed by the NCERT across classes have been taken into consideration in this exercise.

Contents of the textbooks have been rationalised in view of the following:

- Overlapping with similar content included in other subject areas in the same class
- Similar content included in the lower or higher class in the same subject
- Difficulty level
- Content, which is easily accessible to students without much interventions from teachers and can be learned by children through self-learning or peer-learning
- Content, which is irrelevant in the present context

This present edition, is a reformatted version after carrying out the changes given above.

© NCERT
not to be republished

TEXTBOOK DEVELOPMENT COMMITTEE

CHAIRPERSON, ADVISORY GROUP FOR TEXTBOOKS IN SCIENCE AND MATHEMATICS

J.V. Narlikar, *Emeritus Professor*, Inter-University Centre for Astronomy and Astrophysics (IUCAA), Ganeshkhind, Pune University Campus, Pune

CHIEF ADVISOR

A.W. Joshi, Honorary Visiting Scientist, National Centre for Radio Astrophysics (NCRA), Pune University Campus, Pune (Formerly *Professor* at Department of Physics, University of Pune)

MEMBERS

A.K. Ghatak, *Emeritus Professor*, Department of Physics, Indian Institute of Technology, New Delhi

Alika Khare, *Professor*, Department of Physics, Indian Institute of Technology, Guwahati

Anjali Kshirsagar, *Reader*, Department of Physics, University of Pune, Pune

Anuradha Mathur, *PGT*, Modern School, Vasant Vihar, New Delhi

Atul Mody, *Lecturer (S.G.)*, VES College of Arts, Science and Commerce, Mumbai

B.K. Sharma, *Professor*, DESM, NCERT, New Delhi

Chitra Goel, *PGT*, Rajkiya Pratibha Vikas Vidyalaya, Tyagraj Nagar, New Delhi

Gagan Gupta, *Reader*, DESM, NCERT, New Delhi

H.C. Pradhan, *Professor*, Homi Bhabha Centre of Science Education (TIFR), Mumbai

N. Panchapakesan, *Professor (Retd.)*, Department of Physics and Astrophysics, University of Delhi, Delhi

R. Joshi, *Lecturer (S.G.)*, DESM, NCERT, New Delhi

S.K. Dash, *Reader*, DESM, NCERT, New Delhi

S. Rai Choudhary, *Professor*, Department of Physics and Astrophysics, University of Delhi, Delhi

S.K. Upadhyay, *PGT*, Jawahar Navodaya Vidyalaya, Muzaffar Nagar

S.N. Prabhakara, *PGT*, DM School, Regional Institute of Education (NCERT), Mysore

V.H. Raybagkar, *Reader*, Nowrosjee Wadia College, Pune

Vishwajeet Kulkarni, *Teacher (Grade I)*, Higher Secondary Section, Smt. Parvatibai Chowgule College, Margao, Goa

MEMBER-COORDINATOR

V.P. Srivastava, *Reader*, DESM, NCERT, New Delhi

Constitution of India

Part IV A (Article 51 A)

Fundamental Duties

It shall be the duty of every citizen of India —

- (a) to abide by the Constitution and respect its ideals and institutions, the National Flag and the National Anthem;
- (b) to cherish and follow the noble ideals which inspired our national struggle for freedom;
- (c) to uphold and protect the sovereignty, unity and integrity of India;
- (d) to defend the country and render national service when called upon to do so;
- (e) to promote harmony and the spirit of common brotherhood amongst all the people of India transcending religious, linguistic and regional or sectional diversities; to renounce practices derogatory to the dignity of women;
- (f) to value and preserve the rich heritage of our composite culture;
- (g) to protect and improve the natural environment including forests, lakes, rivers, wildlife and to have compassion for living creatures;
- (h) to develop the scientific temper, humanism and the spirit of inquiry and reform;
- (i) to safeguard public property and to abjure violence;
- (j) to strive towards excellence in all spheres of individual and collective activity so that the nation constantly rises to higher levels of endeavour and achievement;
- * (k) who is a parent or guardian, to provide opportunities for education to his child or, as the case may be, ward between the age of six and fourteen years.

Note: The Article 51A containing Fundamental Duties was inserted by the Constitution (42nd Amendment) Act, 1976 (with effect from 3 January 1977).

* (k) was inserted by the Constitution (86th Amendment) Act, 2002 (with effect from 1 April 2010).

ACKNOWLEDGEMENTS

The National Council of Educational Research and Training acknowledges the valuable contribution of the individuals and organisations involved in the development of Physics Textbook for Class XII. The Council also acknowledges the valuable contribution of the following academics for reviewing and refining the manuscripts of this book:

Anu Venugopalan, *Lecturer*, School of Basic and Applied Sciences, GGSIP University, Delhi; A.K. Das, *PGT*, St. Xavier's Senior Secondary School, Delhi; Bharati Kukkal, *PGT*, Kendriya Vidyalaya, Pushp Vihar, New Delhi; D.A. Desai, *Lecturer (Retd.)*, Ruparel College, Mumbai; Devendra Kumar, *PGT*, Rajkiya Pratibha Vikas Vidyalaya, Yamuna Vihar, Delhi; I.K. Gogia, *PGT*, Kendriya Vidyalaya, Gole Market, New Delhi; K.C. Sharma, *Reader*, Regional Institute of Education (NCERT), Ajmer; M.K. Nandy, *Associate Professor*, Department of Physics, Indian Institute of Technology, Guwahati; M.N. Bapat, *Reader*, Regional Institute of Education (NCERT), Mysuru; R. Bhattacharjee, *Assistant Professor*, Department of Electronics and Communication Engineering, Indian Institute of Technology, Guwahati; R.S. Das, *Vice-Principal (Retd.)*, Balwant Ray Mehta Senior Secondary School, Lajpat Nagar, New Delhi; Sangeeta D. Gadre, *Reader*, Kirori Mal College, Delhi; Suresh Kumar, *PGT*, Delhi Public School, Dwarka, New Delhi; Sushma Jaireth, *Reader*, Department of Women's Studies, NCERT, New Delhi; Shyama Rath, *Reader*, Department of Physics and Astrophysics, University of Delhi, Delhi; Yashu Kumar, *PGT*, Kulachi Hans Raj Model School, Ashok Vihar, Delhi.

The Council also gratefully acknowledges the valuable contribution of the following academics for the editing and finalisation of this book: B.B. Tripathi, *Professor (Retd.)*, Department of Physics, Indian Institute of Technology, New Delhi; Dipan K. Ghosh, *Professor*, Department of Physics, Indian Institute of Technology, Mumbai; Dipanjan Mitra, *Scientist*, National Centre for Radio Astrophysics (TIFR), Pune; G.K. Mehta, *Raja Ramanna Fellow*, Inter-University Accelerator Centre, New Delhi; G.S. Visweswaran, *Professor*, Department of Electrical Engineering, Indian Institute of Technology, New Delhi; H.C. Kandpal, *Head*, Optical Radiation Standards, National Physical Laboratory, New Delhi; H.S. Mani, *Raja Ramanna Fellow*, Institute of Mathematical Sciences, Chennai; K. Thyagarajan, *Professor*, Department of Physics, Indian Institute of Technology, New Delhi; P.C. Vinod Kumar, *Professor*, Department of Physics, Sardar Patel University, Vallabh Vidyanagar, Gujarat; S. Annapoorni, *Professor*, Department of Physics and Astrophysics, University of Delhi, Delhi; S.C. Dutta Roy, *Emeritus Professor*, Department of Electrical Engineering, Indian Institute of Technology, New Delhi; S.D. Joglekar, *Professor*, Department of Physics, Indian Institute of Technology, Kanpur; and V. Sundara Raja, *Professor*, Sri Venkateswara University, Tirupati.

The Council also acknowledges the valuable contributions of the following academics for refining the text in 2017: A.K. Srivastava, *Assistant Professor*, DESM, NCERT, New Delhi; Arnab Sen, *Assistant Professor*, NERIE, Shillong; L.S. Chauhan, *Assistant Professor*, RIE, Bhopal; O.N. Awasthi, *Professor (Retd.)*, RIE, Bhopal; Rachna Garg, *Professor*, DESM, NCERT, New Delhi; Raman Namboodiri, *Assistant Professor*, RIE, Mysuru; R.R. Koireng, *Assistant Professor*, DCS, NCERT, New Delhi; Shashi Prabha, *Professor*, DESM, NCERT, New Delhi; and S.V. Sharma, *Professor*, RIE, Ajmer.

Special thanks are due to Hukum Singh, *Professor and Head*, DESM, NCERT for his support.

The Council also acknowledges the support provided by the APC office and the administrative staff of the DESM; Deepak Kapoor, *Incharge*, Computer Station; Inder Kumar, *DTP Operator*; Mohd. Qamar Tabrez, *Copy Editor*; Ashima Srivastava, *Proof Reader* in shaping this book.

The contributions of the Publication Department in bringing out this book are also duly acknowledged.

CONSTITUTION OF INDIA

Part III (Articles 12 – 35)

(Subject to certain conditions, some exceptions and reasonable restrictions)

guarantees these

Fundamental Rights

Right to Equality

- before law and equal protection of laws;
- irrespective of religion, race, caste, sex or place of birth;
- of opportunity in public employment;
- by abolition of untouchability and titles.

Right to Freedom

- of expression, assembly, association, movement, residence and profession;
- of certain protections in respect of conviction for offences;
- of protection of life and personal liberty;
- of free and compulsory education for children between the age of six and fourteen years;
- of protection against arrest and detention in certain cases.

Right against Exploitation

- for prohibition of traffic in human beings and forced labour;
- for prohibition of employment of children in hazardous jobs.

Right to Freedom of Religion

- freedom of conscience and free profession, practice and propagation of religion;
- freedom to manage religious affairs;
- freedom as to payment of taxes for promotion of any particular religion;
- freedom as to attendance at religious instruction or religious worship in educational institutions wholly maintained by the State.

Cultural and Educational Rights

- for protection of interests of minorities to conserve their language, script and culture;
- for minorities to establish and administer educational institutions of their choice.

Right to Constitutional Remedies

- by issuance of directions or orders or writs by the Supreme Court and High Courts for enforcement of these Fundamental Rights.



PREFACE

It gives me pleasure to place this book in the hands of the students, teachers and the public at large (whose role cannot be overlooked). It is a natural sequel to the Class XI textbook which was brought out in 2006. This book is also a trimmed version of the textbooks which existed so far. The chapter on thermal and chemical effects of current has been cut out. This topic has also been dropped from the CBSE syllabus. Similarly, the chapter on communications has been substantially curtailed. It has been rewritten in an easily comprehensible form.

Although most other chapters have been based on the earlier versions, several parts and sections in them have been rewritten. The Development Team has been guided by the feedback received from innumerable teachers across the country.

In producing these books, Class XI as well as Class XII, there has been a basic change of emphasis. Both the books present physics to students without assuming that they would pursue this subject beyond the higher secondary level. This new view has been prompted by the various observations and suggestions made in the National Curriculum Framework (NCF), 2005. Similarly, in today's educational scenario where students can opt for various combinations of subjects, we cannot assume that a physics student is also studying mathematics. Therefore, physics has to be presented, so to say, in a standalone form.

As in Class XI textbook, some interesting box items have been inserted in many chapters. They are not meant for teaching or examinations. Their purpose is to catch the attention of the reader, to show some applications in daily life or in other areas of science and technology, to suggest a simple experiment, to show connection of concepts in different areas of physics, and in general, to break the monotony and enliven the book.

Features like Summary, Points to Ponder, Exercises and Additional Exercises at the end of each chapter, and Examples have been retained. Several concept-based Exercises have been transferred from end-of-chapter Exercises to Examples with Solutions in the text. It is hoped that this will make the concepts discussed in the chapter more comprehensible. Several new examples and exercises have been added. Students wishing to pursue physics further would find Points to Ponder and Additional Exercises very useful and thoughtful. To provide *resources beyond the textbook* and to encourage *eLearning*, each chapter has been provided with some relevant website addresses under the title *ePhysics*. These sites provide additional material on specific topics and also provide learners with opportunities for interactive demonstrations/experiments.

The intricate concepts of physics must be understood, comprehended and appreciated. Students must learn to ask questions like 'why', 'how', 'how do we know it'. They will find almost always that the question 'why' has no answer within the domain of physics and science in general. But that itself is a learning experience, is it not? On the other hand, the question 'how' has been reasonably well answered by physicists in the case of most natural phenomena. In fact, with the understanding of how things happen, it has been possible to make use of many phenomena to create technological applications for the use of humans.

For example, consider statements in a book, like 'A negatively charged electron is attracted by the positively charged plate', or 'In this experiment, light (or electron) behaves like a wave'. You will realise that it is not possible to answer 'why'. This question belongs to the domain of philosophy or metaphysics. But we can answer 'how', we can find the force acting, we can find

the wavelength of the photon (or electron), we can determine how things behave under different conditions, and we can develop instruments which will use these phenomena to our advantage.

It has been a pleasure to work for these books at the higher secondary level, along with a team of members. The Textbook Development Team, Review Team and Editing Teams involved college and university teachers, teachers from Indian Institutes of Technology, scientists from national institutes and laboratories, as well as, higher secondary teachers. The feedback and critical look provided by higher secondary teachers in the various teams are highly laudable. Most box items were generated by members of one or the other team, but three of them were generated by friends and well-wishers not part of any team. We are thankful to Dr P.N. Sen of Pune, Professor Roopmanjari Ghosh of Delhi and Dr Rajesh B Khaparde of Mumbai for allowing us to use their box items, respectively, in Chapters 3, 4 (Part I) and 9 (Part II). We are thankful to the members of the review and editing workshops to discuss and refine the first draft of the textbook. We also express our gratitude to Prof. Krishna Kumar, *Director*, NCERT, for entrusting us with the task of presenting this textbook as a part of the national effort for improving science education. I also thank Prof. G. Ravindra, *Joint Director*, NCERT, for his help from time-to-time. Prof. Hukum Singh, *Head*, Department of Education in Science and Mathematics, NCERT, was always willing to help us in our endeavour in every possible way.

We welcome suggestions and comments from our valued users, especially students and teachers. We wish our young readers a happy journey into the exciting realm of physics.

A. W. JOSHI
Chief Advisor
Textbook Development Committee

CONTENTS

FOREWORD	<i>iii</i>
RATIONALISATION OF CONTENT IN THE TEXTBOOKS	<i>v</i>
CHAPTER ONE	
ELECTRIC CHARGES AND FIELDS	
1.1 Introduction	1
1.2 Electric Charge	1
1.3 Conductors and Insulators	3
1.4 Basic Properties of Electric Charge	4
1.5 Coulomb's Law	6
1.6 Forces between Multiple Charges	11
1.7 Electric Field	14
1.8 Electric Field Lines	19
1.9 Electric Flux	21
1.10 Electric Dipole	23
1.11 Dipole in a Uniform External Field	27
1.12 Continuous Charge Distribution	28
1.13 Gauss's Law	29
1.14 Applications of Gauss's Law	33
CHAPTER TWO	
ELECTROSTATIC POTENTIAL AND CAPACITANCE	
2.1 Introduction	45
2.2 Electrostatic Potential	47
2.3 Potential due to a Point Charge	48
2.4 Potential due to an Electric Dipole	49
2.5 Potential due to a System of Charges	51
2.6 Equipotential Surfaces	54
2.7 Potential Energy of a System of Charges	55
2.8 Potential Energy in an External Field	58
2.9 Electrostatics of Conductors	61
2.10 Dielectrics and Polarisation	65
2.11 Capacitors and Capacitance	67
2.12 The Parallel Plate Capacitor	68
2.13 Effect of Dielectric on Capacitance	69
2.14 Combination of Capacitors	71
2.15 Energy Stored in a Capacitor	73

CHAPTER THREE

CURRENT ELECTRICITY

3.1	Introduction	81
3.2	Electric Current	81
3.3	Electric Currents in Conductors	82
3.4	Ohm's law	83
3.5	Drift of Electrons and the Origin of Resistivity	85
3.6	Limitations of Ohm's Law	89
3.7	Resistivity of Various Materials	89
3.8	Temperature Dependence of Resistivity	90
3.9	Electrical Energy, Power	92
3.10	Cells, emf, Internal Resistance	93
3.11	Cells in Series and in Parallel	95
3.12	Kirchhoff's Rules	97
3.13	Wheatstone Bridge	100

CHAPTER FOUR

MOVING CHARGES AND MAGNETISM

4.1	Introduction	107
4.2	Magnetic Force	108
4.3	Motion in a Magnetic Field	112
4.4	Magnetic Field due to a Current Element, Biot-Savart Law	113
4.5	Magnetic Field on the Axis of a Circular Current Loop	115
4.6	Ampere's Circuital Law	117
4.7	The Solenoid	121
4.8	Force between Two Parallel Currents, the Ampere	122
4.9	Torque on Current Loop, Magnetic Dipole	124
4.10	The Moving Coil Galvanometer	129

CHAPTER FIVE

MAGNETISM AND MATTER

5.1	Introduction	136
5.2	The Bar Magnet	137
5.3	Magnetism and Gauss's Law	142
5.4	Magnetisation and Magnetic Intensity	145
5.5	Magnetic Properties of Materials	147

CHAPTER SIX

ELECTROMAGNETIC INDUCTION

6.1	Introduction	154
6.2	The Experiments of Faraday and Henry	155
6.3	Magnetic Flux	156
6.4	Faraday's Law of Induction	157
6.5	Lenz's Law and Conservation of Energy	160
6.6	Motional Electromotive Force	162
6.7	Inductance	165
6.8	AC Generator	170

CHAPTER SEVEN

ALTERNATING CURRENT

7.1	Introduction	177
7.2	AC Voltage Applied to a Resistor	178
7.3	Representation of AC Current and Voltage by Rotating Vectors — Phasors	181
7.4	AC Voltage Applied to an Inductor	181
7.5	AC Voltage Applied to a Capacitor	184
7.6	AC Voltage Applied to a Series LCR Circuit	186
7.7	Power in AC Circuit: The Power Factor	190
7.8	Transformers	194

CHAPTER EIGHT

ELECTROMAGNETIC WAVES

8.1	Introduction	201
8.2	Displacement Current	202
8.3	Electromagnetic Waves	205
8.4	Electromagnetic Spectrum	208

ANSWERS	215
----------------	-----

COVER DESIGN

(Adapted from <http://nobelprize.org> and
the Nobel Prize in Physics 2006)

Different stages in the evolution of
the universe.

BACK COVER

(Adapted from <http://www.iter.org> and
<http://www.dae.gov.in>)

Cut away view of *International Thermonuclear Experimental Reactor (ITER)* device. The man in the bottom shows the scale.

ITER is a joint international research and development project that aims to demonstrate the scientific and technical feasibility of fusion power.

India is one of the seven full partners in the project, the others being the European Union (represented by EURATOM), Japan, the People's Republic of China, the Republic of Korea, the Russian Federation and the USA. ITER will be constructed in Europe, at Cadarache in the South of France and will provide 500 MW of fusion power.

Fusion is the energy source of the sun and the stars. On earth, fusion research is aimed at demonstrating that this energy source can be used to produce electricity in a safe and environmentally benign way, with abundant fuel resources, to meet the needs of a growing world population.

For details of India's role, see *Nuclear India*, Vol. 39, Nov. 11-12/ May-June 2006, issue available at Department of Atomic Energy (DAE) website mentioned above.



Chapter One

ELECTRIC CHARGES AND FIELDS

1.1 INTRODUCTION

All of us have the experience of seeing a spark or hearing a crackle when we take off our synthetic clothes or sweater, particularly in dry weather. Have you ever tried to find any explanation for this phenomenon? Another common example of electric discharge is the lightning that we see in the sky during thunderstorms. We also experience a sensation of an electric shock either while opening the door of a car or holding the iron bar of a bus after sliding from our seat. The reason for these experiences is discharge of electric charges through our body, which were accumulated due to rubbing of insulating surfaces. You might have also heard that this is due to generation of static electricity. This is precisely the topic we are going to discuss in this and the next chapter. Static means anything that does not move or change with time. *Electrostatics deals with the study of forces, fields and potentials arising from static charges.*

1.2 ELECTRIC CHARGE

Historically the credit of discovery of the fact that amber rubbed with wool or silk cloth attracts light objects goes to Thales of Miletus, Greece, around 600 BC. The name electricity is coined from the Greek word

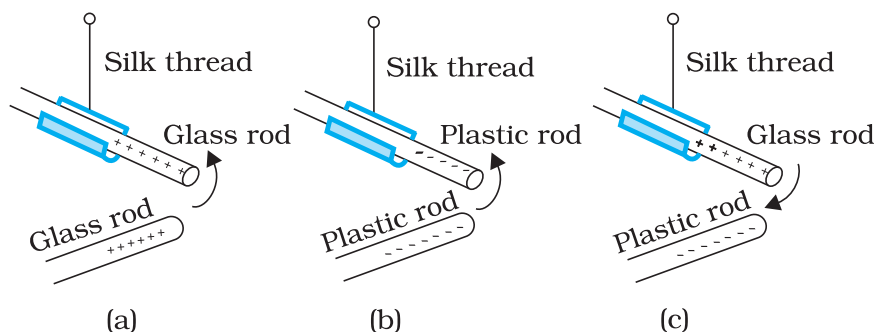

FIGURE 1.1 Rods: like charges repel and unlike charges attract each other.

elektron meaning *amber*. Many such pairs of materials were known which on rubbing could attract light objects like straw, pith balls and bits of papers.

It was observed that if two glass rods rubbed with wool or silk cloth are brought close to each other, they repel each other [Fig. 1.1(a)]. The two strands of wool or two pieces of silk cloth, with which the rods were rubbed, also repel each other. However, the glass rod and wool attracted each other. Similarly, two plastic rods rubbed with cat's fur repelled each other [Fig. 1.1(b)] but attracted the fur. On the other hand, the plastic rod attracts the glass rod [Fig. 1.1(c)] and repel the silk or wool with which the glass rod is rubbed. The glass rod repels the fur.

These seemingly simple facts were established from years of efforts and careful experiments and their analyses. It was concluded, after many careful studies by different scientists, that there were only two kinds of an entry which is called the *electric charge*. We say that the bodies like glass or plastic rods, silk, fur and pith balls are electrified. They acquire an electric charge on rubbing. There are two kinds of electrification and we find that (i) *like charges repel* and (ii) *unlike charges attract* each other. The property which differentiates the two kinds of charges is called the *polarity* of charge.

When a glass rod is rubbed with silk, the rod acquires one kind of charge and the silk acquires the second kind of charge. This is true for any pair of objects that are rubbed to be electrified. Now if the electrified glass rod is brought in contact with silk, with which it was rubbed, they no longer attract each other. They also do not attract or repel other light objects as they did on being electrified.

Thus, the charges acquired after rubbing are lost when the charged bodies are brought in contact. What can you conclude from these observations? It just tells us that unlike charges acquired by the objects neutralise or nullify each other's effect. Therefore, the charges were named as *positive* and *negative* by the American scientist Benjamin Franklin. By convention, the charge on glass rod or cat's fur is called positive and that on plastic rod or silk is termed negative. If an object possesses an electric charge, it is said to be electrified or charged. When it has no charge it is said to be electrically neutral.

A simple apparatus to detect charge on a body is the *gold-leaf electroscope* [Fig. 1.2(a)]. It consists of a vertical metal rod housed in a box, with two thin gold leaves attached to its bottom end. When a charged object touches the metal knob at the top of the rod, charge flows on to the leaves and they diverge. The degree of divergence is an indicator of the amount of charge.

Try to understand why material bodies acquire charge. You know that all matter is made up of atoms and/or molecules. Although normally the materials are electrically neutral, they do contain charges; but their charges are exactly balanced. Forces that hold the molecules together, forces that hold atoms together in a solid, the adhesive force of glue, forces associated with surface tension, all are basically electrical in nature, arising from the forces between charged particles. Thus the electric force is all pervasive and it encompasses almost each and every field associated with our life. It is therefore essential that we learn more about such a force.

To electrify a neutral body, we need to add or remove one kind of charge. When we say that a body is charged, we always refer to this excess charge or deficit of charge. In solids, some of the electrons, being less tightly bound in the atom, are the charges which are transferred from one body to the other. A body can thus be charged positively by losing some of its electrons. Similarly, a body can be charged negatively by gaining electrons. When we rub a glass rod with silk, some of the electrons from the rod are transferred to the silk cloth. Thus the rod gets positively charged and the silk gets negatively charged. No new charge is created in the process of rubbing. Also the number of electrons, that are transferred, is a very small fraction of the total number of electrons in the material body.

1.3 CONDUCTORS AND INSULATORS

Some substances readily allow passage of electricity through them, others do not. Those which allow electricity to pass through them easily are called *conductors*. They have electric charges (electrons) that are comparatively free to move inside the material. Metals, human and animal bodies and earth are conductors. Most of the non-metals like glass, porcelain, plastic, nylon, wood offer high resistance to the passage of electricity through them. They are called *insulators*. Most substances fall into one of the two classes stated above*.

When some charge is transferred to a conductor, it readily gets distributed over the entire surface of the conductor. In contrast, if some charge is put on an insulator, it stays at the same place. You will learn why this happens in the next chapter.

This property of the materials tells you why a nylon or plastic comb gets electrified on combing dry hair or on rubbing, but a metal article

* There is a third category called *semiconductors*, which offer resistance to the movement of charges which is intermediate between the conductors and insulators.

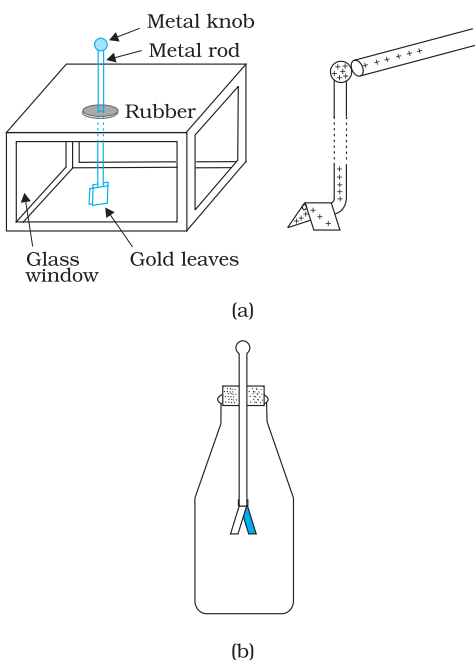

FIGURE 1.2 Electroscopes: (a) The gold leaf electroscope, (b) Schematics of a simple electroscope.

like spoon does not. The charges on metal leak through our body to the ground as both are conductors of electricity. However, if a metal rod with a wooden or plastic handle is rubbed without touching its metal part, it shows signs of charging.

1.4 BASIC PROPERTIES OF ELECTRIC CHARGE

We have seen that there are two types of charges, namely positive and negative and their effects tend to cancel each other. Here, we shall now describe some other properties of the electric charge.

If the sizes of charged bodies are very small as compared to the distances between them, we treat them as *point charges*. All the charge content of the body is assumed to be concentrated at one point in space.

1.4.1 Additivity of charges

We have not as yet given a quantitative definition of a charge; we shall follow it up in the next section. We shall tentatively assume that this can be done and proceed. If a system contains two point charges q_1 and q_2 , the total charge of the system is obtained simply by adding algebraically q_1 and q_2 , i.e., charges add up like real numbers or they are scalars like the mass of a body. If a system contains n charges $q_1, q_2, q_3, \dots, q_n$, then the total charge of the system is $q_1 + q_2 + q_3 + \dots + q_n$. Charge has magnitude but no direction, similar to mass. However, there is one difference between mass and charge. Mass of a body is always positive whereas a charge can be either positive or negative. Proper signs have to be used while adding the charges in a system. For example, the total charge of a system containing five charges $+1, +2, -3, +4$ and -5 , in some arbitrary unit, is $(+1) + (+2) + (-3) + (+4) + (-5) = -1$ in the same unit.

1.4.2 Charge is conserved

We have already hinted to the fact that when bodies are charged by rubbing, there is transfer of electrons from one body to the other; no new charges are either created or destroyed. A picture of particles of electric charge enables us to understand the idea of conservation of charge. When we rub two bodies, what one body gains in charge the other body loses. Within an isolated system consisting of many charged bodies, due to interactions among the bodies, charges may get redistributed but it is found that *the total charge of the isolated system is always conserved*. Conservation of charge has been established experimentally.

It is not possible to create or destroy net charge carried by any isolated system although the charge carrying particles may be created or destroyed

in a process. Sometimes nature creates charged particles: a neutron turns into a proton and an electron. The proton and electron thus created have equal and opposite charges and the total charge is zero before and after the creation.

1.4.3 Quantisation of charge

Experimentally it is established that all free charges are integral multiples of a basic unit of charge denoted by e . Thus charge q on a body is always given by

$$q = ne$$

where n is any integer, positive or negative. This basic unit of charge is the charge that an electron or proton carries. By convention, the charge on an electron is taken to be negative; therefore charge on an electron is written as $-e$ and that on a proton as $+e$.

The fact that electric charge is always an integral multiple of e is termed as *quantisation of charge*. There are a large number of situations in physics where certain physical quantities are quantised. The quantisation of charge was first suggested by the experimental laws of electrolysis discovered by English experimentalist Faraday. It was experimentally demonstrated by Millikan in 1912.

In the International System (SI) of Units, a unit of charge is called a *coulomb* and is denoted by the symbol C. A coulomb is defined in terms the unit of the electric current which you are going to learn in a subsequent chapter. In terms of this definition, one coulomb is the charge flowing through a wire in 1 s if the current is 1 A (ampere), (see Chapter 1 of Class XI, Physics Textbook , Part I). In this system, the value of the basic unit of charge is

$$e = 1.602192 \times 10^{-19} \text{ C}$$

Thus, there are about 6×10^{18} electrons in a charge of -1C . In electrostatics, charges of this large magnitude are seldom encountered and hence we use smaller units $1 \mu\text{C}$ (micro coulomb) = 10^{-6} C or 1 mC (milli coulomb) = 10^{-3} C .

If the protons and electrons are the only basic charges in the universe, all the observable charges have to be integral multiples of e . Thus, if a body contains n_1 electrons and n_2 protons, the total amount of charge on the body is $n_2 \times e + n_1 \times (-e) = (n_2 - n_1) e$. Since n_1 and n_2 are integers, their difference is also an integer. Thus the charge on any body is always an integral multiple of e and can be increased or decreased also in steps of e .

The step size e is, however, very small because at the macroscopic level, we deal with charges of a few μC . At this scale the fact that charge of a body can increase or decrease in units of e is not visible. In this respect, the grainy nature of the charge is lost and it appears to be continuous.

This situation can be compared with the geometrical concepts of points and lines. A dotted line viewed from a distance appears continuous to us but is not continuous in reality. As many points very close to

each other normally give an impression of a continuous line, many small charges taken together appear as a continuous charge distribution.

At the macroscopic level, one deals with charges that are enormous compared to the magnitude of charge e . Since $e = 1.6 \times 10^{-19}$ C, a charge of magnitude, say 1 μ C, contains something like 10^{13} times the electronic charge. At this scale, the fact that charge can increase or decrease only in units of e is not very different from saying that charge can take continuous values. Thus, at the macroscopic level, the quantisation of charge has no practical consequence and can be ignored. However, at the microscopic level, where the charges involved are of the order of a few tens or hundreds of e , i.e., they can be counted, they appear in discrete lumps and quantisation of charge cannot be ignored. It is the magnitude of scale involved that is very important.

EXAMPLE 1.1

Example 1.1 If 10^9 electrons move out of a body to another body every second, how much time is required to get a total charge of 1 C on the other body?

Solution In one second 10^9 electrons move out of the body. Therefore the charge given out in one second is $1.6 \times 10^{-19} \times 10^9$ C = 1.6×10^{-10} C. The time required to accumulate a charge of 1 C can then be estimated to be $1 \text{ C} \div (1.6 \times 10^{-10} \text{ C/s}) = 6.25 \times 10^9 \text{ s} = 6.25 \times 10^9 \div (365 \times 24 \times 3600)$ years = 198 years. Thus to collect a charge of one coulomb, from a body from which 10^9 electrons move out every second, we will need approximately 200 years. One coulomb is, therefore, a very large unit for many practical purposes.

It is, however, also important to know what is roughly the number of electrons contained in a piece of one cubic centimetre of a material. A cubic piece of copper of side 1 cm contains about 2.5×10^{24} electrons.

EXAMPLE 1.2

Example 1.2 How much positive and negative charge is there in a cup of water?

Solution Let us assume that the mass of one cup of water is 250 g. The molecular mass of water is 18g. Thus, one mole (= 6.02×10^{23} molecules) of water is 18 g. Therefore the number of molecules in one cup of water is $(250/18) \times 6.02 \times 10^{23}$.

Each molecule of water contains two hydrogen atoms and one oxygen atom, i.e., 10 electrons and 10 protons. Hence the total positive and total negative charge has the same magnitude. It is equal to $(250/18) \times 6.02 \times 10^{23} \times 10 \times 1.6 \times 10^{-19}$ C = 1.34×10^7 C.

1.5 COULOMB'S LAW

Coulomb's law is a quantitative statement about the force between two point charges. When the linear size of charged bodies are much smaller than the distance separating them, the size may be ignored and the charged bodies are treated as *point charges*. Coulomb measured the force between two point charges and found that *it varied inversely as the square of the distance between the charges and was directly proportional to the product of the magnitude of the two charges and*

Electric Charges and Fields

acted along the line joining the two charges. Thus, if two point charges q_1, q_2 are separated by a distance r in vacuum, the magnitude of the force (\mathbf{F}) between them is given by

$$F = k \frac{|q_1 q_2|}{r^2} \quad (1.1)$$

How did Coulomb arrive at this law from his experiments? Coulomb used a torsion balance* for measuring the force between two charged metallic spheres. When the separation between two spheres is much larger than the radius of each sphere, the charged spheres may be regarded as point charges. However, the charges on the spheres were unknown, to begin with. How then could he discover a relation like Eq. (1.1)? Coulomb thought of the following simple way: Suppose the charge on a metallic sphere is q . If the sphere is put in contact with an identical uncharged sphere, the charge will spread over the two spheres. By symmetry, the charge on each sphere will be $q/2$ *. Repeating this process, we can get charges $q/2, q/4$, etc. Coulomb varied the distance for a fixed pair of charges and measured the force for different separations. He then varied the charges in pairs, keeping the distance fixed for each pair. Comparing forces for different pairs of charges at different distances, Coulomb arrived at the relation, Eq. (1.1).

Coulomb's law, a simple mathematical statement, was initially experimentally arrived at in the manner described above. While the original experiments established it at a macroscopic scale, it has also been established down to subatomic level ($r \sim 10^{-10}$ m).

Coulomb discovered his law without knowing the *explicit* magnitude of the charge. In fact, it is the other way round: Coulomb's law can *now* be employed to furnish a definition for a unit of charge. In the relation, Eq. (1.1), k is so far arbitrary. We can choose any positive value of k . The choice of k determines the size of the unit of charge. In SI units, the value of k is about $9 \times 10^9 \frac{\text{Nm}^2}{\text{C}^2}$. The unit of charge that results from this choice is called a coulomb which we defined earlier in Section 1.4. Putting this value of k in Eq. (1.1), we see that for $q_1 = q_2 = 1 \text{ C}$, $r = 1 \text{ m}$

$$F = 9 \times 10^9 \text{ N}$$

That is, 1 C is the charge that when placed at a distance of 1 m from another charge of the same magnitude *in vacuum* experiences an electrical force of repulsion of magnitude

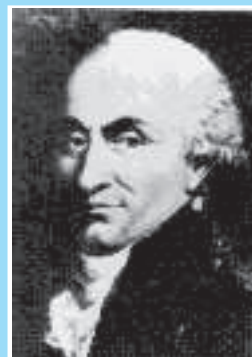

Charles Augustin de Coulomb (1736 – 1806)

Coulomb, a French physicist, began his career as a military engineer in the West Indies. In 1776, he returned to Paris and retired to a small estate to do his scientific research. He invented a torsion balance to measure the quantity of a force and used it for determination of forces of electric attraction or repulsion between small charged spheres. He thus arrived in 1785 at the inverse square law relation, now known as Coulomb's law. The law had been anticipated by Priestley and also by Cavendish earlier, though Cavendish never published his results. Coulomb also found the inverse square law of force between unlike and like magnetic poles.

CHARLES AUGUSTIN DE COULOMB (1736 – 1806)

* A torsion balance is a sensitive device to measure force. It was also used later by Cavendish to measure the very feeble gravitational force between two objects, to verify Newton's Law of Gravitation.

* Implicit in this is the assumption of additivity of charges and conservation: two charges ($q/2$ each) add up to make a total charge q .

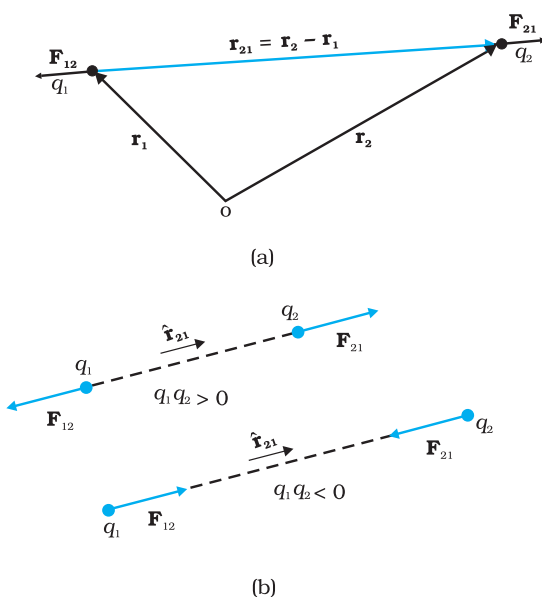

FIGURE 1.3 (a) Geometry and (b) Forces between charges.

9×10^9 N. One coulomb is evidently too big a unit to be used. In practice, in electrostatics, one uses smaller units like 1 mC or 1 μ C.

The constant k in Eq. (1.1) is usually put as $k = 1/4\pi\epsilon_0$ for later convenience, so that Coulomb's law is written as

$$F = \frac{1}{4\pi\epsilon_0} \frac{|q_1 q_2|}{r^2} \quad (1.2)$$

ϵ_0 is called the *permittivity of free space*. The value of ϵ_0 in SI units is

$$\epsilon_0 = 8.854 \times 10^{-12} \text{ C}^2 \text{ N}^{-1} \text{ m}^{-2}$$

Since force is a vector, it is better to write Coulomb's law in the vector notation. Let the position vectors of charges q_1 and q_2 be \mathbf{r}_1 and \mathbf{r}_2 respectively [see Fig. 1.3(a)]. We denote force on q_1 due to q_2 by \mathbf{F}_{12} and force on q_2 due to q_1 by \mathbf{F}_{21} . The two point charges q_1 and q_2 have been numbered 1 and 2 for convenience and the vector leading from 1 to 2 is

denoted by \mathbf{r}_{21} :

$$\mathbf{r}_{21} = \mathbf{r}_2 - \mathbf{r}_1$$

In the same way, the vector leading from 2 to 1 is denoted by \mathbf{r}_{12} :

$$\mathbf{r}_{12} = \mathbf{r}_1 - \mathbf{r}_2 = -\mathbf{r}_{21}$$

The magnitude of the vectors \mathbf{r}_{21} and \mathbf{r}_{12} is denoted by r_{21} and r_{12} , respectively ($r_{12} = r_{21}$). The direction of a vector is specified by a unit vector along the vector. To denote the direction from 1 to 2 (or from 2 to 1), we define the unit vectors:

$$\hat{\mathbf{r}}_{21} = \frac{\mathbf{r}_{21}}{r_{21}}, \quad \hat{\mathbf{r}}_{12} = \frac{\mathbf{r}_{12}}{r_{12}}, \quad \hat{\mathbf{r}}_{21} = -\hat{\mathbf{r}}_{12}$$

Coulomb's force law between two point charges q_1 and q_2 located at \mathbf{r}_1 and \mathbf{r}_2 , respectively is then expressed as

$$\mathbf{F}_{21} = \frac{1}{4\pi\epsilon_0} \frac{q_1 q_2}{r_{21}^2} \hat{\mathbf{r}}_{21} \quad (1.3)$$

Some remarks on Eq. (1.3) are relevant:

- Equation (1.3) is valid for any sign of q_1 and q_2 whether positive or negative. If q_1 and q_2 are of the same sign (either both positive or both negative), \mathbf{F}_{21} is along $\hat{\mathbf{r}}_{21}$, which denotes repulsion, as it should be for like charges. If q_1 and q_2 are of opposite signs, \mathbf{F}_{21} is along $-\hat{\mathbf{r}}_{21}$ ($= \hat{\mathbf{r}}_{12}$), which denotes attraction, as expected for unlike charges. Thus, we do not have to write separate equations for the cases of like and unlike charges. Equation (1.3) takes care of both cases correctly [Fig. 1.3(b)].

- The force \mathbf{F}_{12} on charge q_1 due to charge q_2 , is obtained from Eq. (1.3), by simply interchanging 1 and 2, i.e.,

$$\mathbf{F}_{12} = \frac{1}{4\pi\epsilon_0} \frac{q_1 q_2}{r_{12}^2} \hat{\mathbf{r}}_{12} = -\mathbf{F}_{21}$$

Thus, Coulomb's law agrees with the Newton's third law.

- Coulomb's law [Eq. (1.3)] gives the force between two charges q_1 and q_2 in vacuum. If the charges are placed in matter or the intervening space has matter, the situation gets complicated due to the presence of charged constituents of matter. We shall consider electrostatics in matter in the next chapter.

Example 1.3 Coulomb's law for electrostatic force between two point charges and Newton's law for gravitational force between two stationary point masses, both have inverse-square dependence on the distance between the charges and masses respectively. (a) Compare the strength of these forces by determining the ratio of their magnitudes (i) for an electron and a proton and (ii) for two protons. (b) Estimate the accelerations of electron and proton due to the electrical force of their mutual attraction when they are 1 \AA ($= 10^{-10} \text{ m}$) apart? ($m_p = 1.67 \times 10^{-27} \text{ kg}$, $m_e = 9.11 \times 10^{-31} \text{ kg}$)

Solution

- (a) (i) The electric force between an electron and a proton at a distance r apart is:

$$F_e = -\frac{1}{4\pi\epsilon_0} \frac{e^2}{r^2}$$

where the negative sign indicates that the force is attractive. The corresponding gravitational force (always attractive) is:

$$F_G = -G \frac{m_p m_e}{r^2}$$

where m_p and m_e are the masses of a proton and an electron respectively.

$$\left| \frac{F_e}{F_G} \right| = \frac{e^2}{4\pi\epsilon_0 G m_p m_e} = 2.4 \times 10^{39}$$

- (ii) On similar lines, the ratio of the magnitudes of electric force to the gravitational force between two protons at a distance r apart is:

$$\left| \frac{F_e}{F_G} \right| = \frac{e^2}{4\pi\epsilon_0 G m_p m_p} = 1.3 \times 10^{36}$$

However, it may be mentioned here that the signs of the two forces are different. For two protons, the gravitational force is attractive in nature and the Coulomb force is repulsive. The actual values of these forces between two protons inside a nucleus (distance between two protons is $\sim 10^{-15} \text{ m}$ inside a nucleus) are $F_e \sim 230 \text{ N}$, whereas, $F_G \sim 1.9 \times 10^{-34} \text{ N}$.

The (dimensionless) ratio of the two forces shows that electrical forces are enormously stronger than the gravitational forces.



Interactive animation on Coulomb's law:
http://webphysics.davidson.edu/phys1et/resources/bu_semester2/menu_semester2.html

EXAMPLE 1.3

(b) The electric force \mathbf{F} exerted by a proton on an electron is same in magnitude to the force exerted by an electron on a proton; however, the masses of an electron and a proton are different. Thus, the magnitude of force is

$$|\mathbf{F}| = \frac{1}{4\pi\epsilon_0} \frac{e^2}{r^2} = 8.987 \times 10^9 \text{ Nm}^2/\text{C}^2 \times (1.6 \times 10^{-19}\text{C})^2 / (10^{-10}\text{m})^2 = 2.3 \times 10^{-8} \text{ N}$$

Using Newton's second law of motion, $F = ma$, the acceleration that an electron will undergo is

$$a = 2.3 \times 10^{-8} \text{ N} / 9.11 \times 10^{-31} \text{ kg} = 2.5 \times 10^{22} \text{ m/s}^2$$

Comparing this with the value of acceleration due to gravity, we can conclude that the effect of gravitational field is negligible on the motion of electron and it undergoes very large accelerations under the action of Coulomb force due to a proton.

The value for acceleration of the proton is

$$2.3 \times 10^{-8} \text{ N} / 1.67 \times 10^{-27} \text{ kg} = 1.4 \times 10^{19} \text{ m/s}^2$$

Example 1.4 A charged metallic sphere A is suspended by a nylon thread. Another charged metallic sphere B held by an insulating

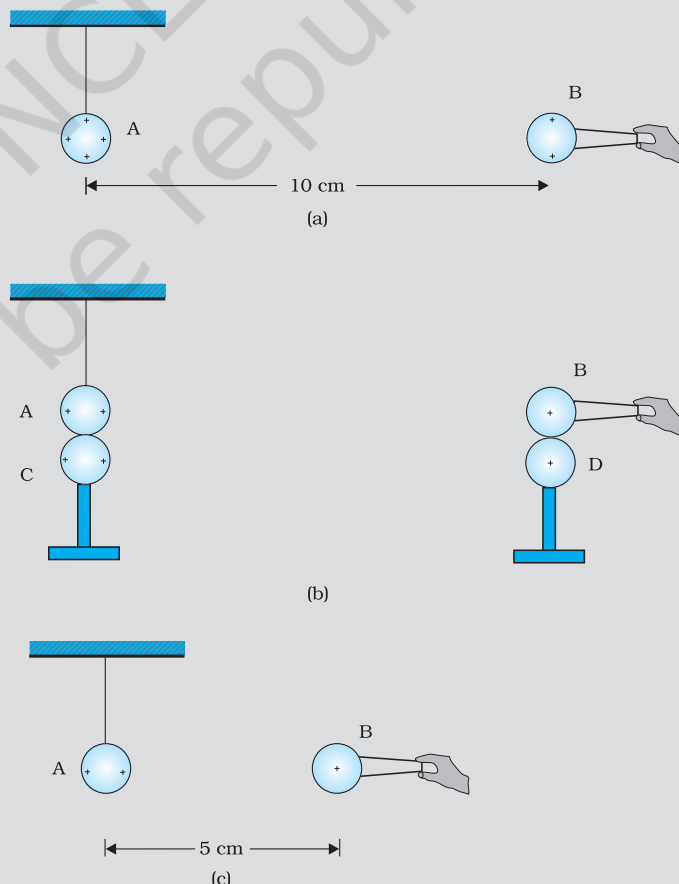

FIGURE 1.4

handle is brought close to A such that the distance between their centres is 10 cm, as shown in Fig. 1.4(a). The resulting repulsion of A is noted (for example, by shining a beam of light and measuring the deflection of its shadow on a screen). Spheres A and B are touched by uncharged spheres C and D respectively, as shown in Fig. 1.4(b). C and D are then removed and B is brought closer to A to a distance of 5.0 cm between their centres, as shown in Fig. 1.4(c). What is the expected repulsion of A on the basis of Coulomb's law? Spheres A and C and spheres B and D have identical sizes. Ignore the sizes of A and B in comparison to the separation between their centres.

Solution Let the original charge on sphere A be q and that on B be q' . At a distance r between their centres, the magnitude of the electrostatic force on each is given by

$$F = \frac{1}{4\pi\epsilon_0} \frac{qq'}{r^2}$$

neglecting the sizes of spheres A and B in comparison to r . When an identical but uncharged sphere C touches A, the charges redistribute on A and C and, by symmetry, each sphere carries a charge $q/2$. Similarly, after D touches B, the redistributed charge on each is $q'/2$. Now, if the separation between A and B is halved, the magnitude of the electrostatic force on each is

$$F' = \frac{1}{4\pi\epsilon_0} \frac{(q/2)(q'/2)}{(r/2)^2} = \frac{1}{4\pi\epsilon_0} \frac{(qq')}{r^2} = F$$

Thus the electrostatic force on A, due to B, remains unaltered.

EXAMPLE 1.4

1.6 FORCES BETWEEN MULTIPLE CHARGES

The mutual electric force between two charges is given by Coulomb's law. How to calculate the force on a charge where there are not one but several charges around? Consider a system of n stationary charges $q_1, q_2, q_3, \dots, q_n$ in vacuum. What is the force on q_1 due to q_2, q_3, \dots, q_n ? Coulomb's law is not enough to answer this question. Recall that forces of mechanical origin add according to the parallelogram law of addition. Is the same true for forces of electrostatic origin?

Experimentally, it is verified that *force on any charge due to a number of other charges is the vector sum of all the forces on that charge due to the other charges, taken one at a time. The individual forces are unaffected due to the presence of other charges.* This is termed as the *principle of superposition*.

To better understand the concept, consider a system of three charges q_1, q_2 and q_3 , as shown in Fig. 1.5(a). The force on one charge, say q_1 , due to two other charges q_2, q_3 can therefore be obtained by performing a vector addition of the forces due to each one of these charges. Thus, if the force on q_1 due to q_2 is denoted by \mathbf{F}_{12} , \mathbf{F}_{12} is given by Eq. (1.3) even though other charges are present.

Thus,
$$\mathbf{F}_{12} = \frac{1}{4\pi\epsilon_0} \frac{q_1 q_2}{r_{12}^2} \hat{\mathbf{r}}_{12}$$

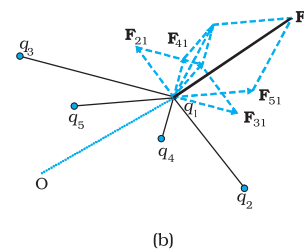
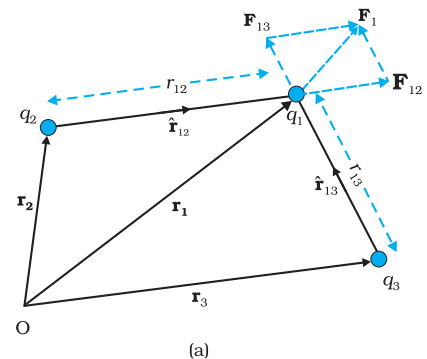

FIGURE 1.5 A system of
(a) three charges
(b) multiple charges.

In the same way, the force on q_1 due to q_3 , denoted by \mathbf{F}_{13} , is given by

$$\mathbf{F}_{13} = \frac{1}{4\pi\epsilon_0} \frac{q_1 q_3}{r_{13}^2} \hat{\mathbf{r}}_{13}$$

which again is the Coulomb force on q_1 due to q_3 , even though other charge q_2 is present.

Thus the total force \mathbf{F}_1 on q_1 due to the two charges q_2 and q_3 is given as

$$\mathbf{F}_1 = \mathbf{F}_{12} + \mathbf{F}_{13} = \frac{1}{4\pi\epsilon_0} \frac{q_1 q_2}{r_{12}^2} \hat{\mathbf{r}}_{12} + \frac{1}{4\pi\epsilon_0} \frac{q_1 q_3}{r_{13}^2} \hat{\mathbf{r}}_{13} \quad (1.4)$$

The above calculation of force can be generalised to a system of charges more than three, as shown in Fig. 1.5(b).

The principle of superposition says that in a system of charges q_1, q_2, \dots, q_n , the force on q_1 due to q_2 is the same as given by Coulomb's law, i.e., it is unaffected by the presence of the other charges q_3, q_4, \dots, q_n . The total force \mathbf{F}_1 on the charge q_1 , due to all other charges, is then given by the vector sum of the forces $\mathbf{F}_{12}, \mathbf{F}_{13}, \dots, \mathbf{F}_{1n}$:

i.e.,

$$\begin{aligned} \mathbf{F}_1 &= \mathbf{F}_{12} + \mathbf{F}_{13} + \dots + \mathbf{F}_{1n} = \frac{1}{4\pi\epsilon_0} \left[\frac{q_1 q_2}{r_{12}^2} \hat{\mathbf{r}}_{12} + \frac{q_1 q_3}{r_{13}^2} \hat{\mathbf{r}}_{13} + \dots + \frac{q_1 q_n}{r_{1n}^2} \hat{\mathbf{r}}_{1n} \right] \\ &= \frac{q_1}{4\pi\epsilon_0} \sum_{i=2}^n \frac{q_i}{r_{1i}^2} \hat{\mathbf{r}}_{1i} \end{aligned} \quad (1.5)$$

The vector sum is obtained as usual by the parallelogram law of addition of vectors. All of electrostatics is basically a consequence of Coulomb's law and the superposition principle.

Example 1.5 Consider three charges q_1, q_2, q_3 each equal to q at the vertices of an equilateral triangle of side l . What is the force on a charge Q (with the same sign as q) placed at the centroid of the triangle, as shown in Fig. 1.6?

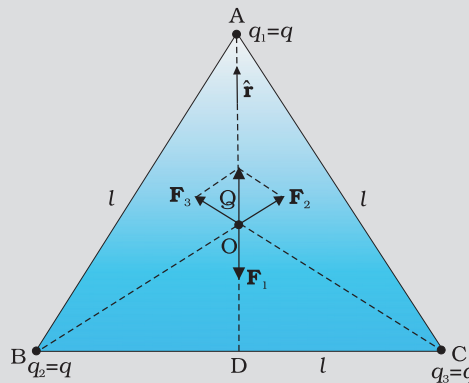

FIGURE 1.6

Solution In the given equilateral triangle ABC of sides of length l , if we draw a perpendicular AD to the side BC,

$AD = AC \cos 30^\circ = (\sqrt{3}/2) l$ and the distance AO of the centroid O from A is $(2/3) AD = (1/\sqrt{3}) l$. By symmetry $AO = BO = CO$.

Thus,

$$\text{Force } \mathbf{F}_1 \text{ on } Q \text{ due to charge } q \text{ at A} = \frac{3}{4\pi\epsilon_0} \frac{Qq}{l^2} \text{ along AO}$$

$$\text{Force } \mathbf{F}_2 \text{ on } Q \text{ due to charge } q \text{ at B} = \frac{3}{4\pi\epsilon_0} \frac{Qq}{l^2} \text{ along BO}$$

$$\text{Force } \mathbf{F}_3 \text{ on } Q \text{ due to charge } q \text{ at C} = \frac{3}{4\pi\epsilon_0} \frac{Qq}{l^2} \text{ along CO}$$

The resultant of forces \mathbf{F}_2 and \mathbf{F}_3 is $\frac{3}{4\pi\epsilon_0} \frac{Qq}{l^2}$ along OA, by the

parallelogram law. Therefore, the total force on $Q = \frac{3}{4\pi\epsilon_0} \frac{Qq}{l^2} (\hat{\mathbf{r}} - \hat{\mathbf{r}})$

$= 0$, where $\hat{\mathbf{r}}$ is the unit vector along OA.

It is clear also by symmetry that the three forces will sum to zero. Suppose that the resultant force was non-zero but in some direction. Consider what would happen if the system was rotated through 60° about O.

EXAMPLE 1.5

Example 1.6 Consider the charges q , q , and $-q$ placed at the vertices of an equilateral triangle, as shown in Fig. 1.7. What is the force on each charge?

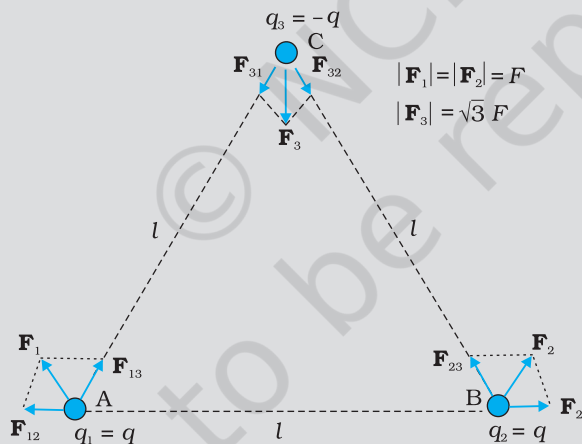

FIGURE 1.7

Solution The forces acting on charge q at A due to charges q at B and $-q$ at C are \mathbf{F}_{12} along BA and \mathbf{F}_{13} along AC respectively, as shown in Fig. 1.7. By the parallelogram law, the total force \mathbf{F}_1 on the charge q at A is given by

$\mathbf{F}_1 = F \hat{\mathbf{r}}_1$ where $\hat{\mathbf{r}}_1$ is a unit vector along BC.

The force of attraction or repulsion for each pair of charges has the

$$\text{same magnitude } F = \frac{q^2}{4\pi\epsilon_0 l^2}$$

The total force \mathbf{F}_2 on charge q at B is thus $\mathbf{F}_2 = F \hat{\mathbf{r}}_2$, where $\hat{\mathbf{r}}_2$ is a unit vector along AC.

EXAMPLE 1.6

Similarly the total force on charge $-q$ at C is $\mathbf{F}_3 = \sqrt{3} F \hat{\mathbf{n}}$, where $\hat{\mathbf{n}}$ is the unit vector along the direction bisecting the $\angle BCA$.

It is interesting to see that the sum of the forces on the three charges is zero, i.e.,

$$\mathbf{F}_1 + \mathbf{F}_2 + \mathbf{F}_3 = 0$$

The result is not at all surprising. It follows straight from the fact that Coulomb's law is consistent with Newton's third law. The proof is left to you as an exercise.

1.7 ELECTRIC FIELD

Let us consider a point charge Q placed in vacuum, at the origin O. If we place another point charge q at a point P, where $\mathbf{OP} = \mathbf{r}$, then the charge Q will exert a force on q as per Coulomb's law. We may ask the question: If charge q is removed, then what is left in the surrounding? Is there nothing? If there is nothing at the point P, then how does a force act when we place the charge q at P. In order to answer such questions, the early scientists introduced the concept of *field*. According to this, we say that the charge Q produces an electric field everywhere in the surrounding. When another charge q is brought at some point P, the field there acts on it and produces a force. The electric field produced by the charge Q at a point \mathbf{r} is given as

$$\mathbf{E}(\mathbf{r}) = \frac{1}{4\pi\epsilon_0} \frac{Q}{r^2} \hat{\mathbf{r}} = \frac{1}{4\pi\epsilon_0} \frac{Q}{r^2} \hat{\mathbf{r}} \quad (1.6)$$

where $\hat{\mathbf{r}} = \mathbf{r}/r$, is a unit vector from the origin to the point \mathbf{r} . Thus, Eq.(1.6) specifies the value of the electric field for each value of the position vector \mathbf{r} . The word "field" signifies how some distributed quantity (which could be a scalar or a vector) varies with position. The effect of the charge has been incorporated in the existence of the electric field. We obtain the force \mathbf{F} exerted by a charge Q on a charge q , as

$$\mathbf{F} = \frac{1}{4\pi\epsilon_0} \frac{Qq}{r^2} \hat{\mathbf{r}} \quad (1.7)$$

Note that the charge q also exerts an equal and opposite force on the charge Q . The electrostatic force between the charges Q and q can be looked upon as an interaction between charge q and the electric field of Q and *vice versa*. If we denote the position of charge q by the vector \mathbf{r} , it experiences a force \mathbf{F} equal to the charge q multiplied by the electric field \mathbf{E} at the location of q . Thus,

$$\mathbf{F}(\mathbf{r}) = q \mathbf{E}(\mathbf{r}) \quad (1.8)$$

Equation (1.8) defines the SI unit of electric field as N/C*.

Some important remarks may be made here:

- (i) From Eq. (1.8), we can infer that if q is unity, the electric field due to a charge Q is numerically equal to the force exerted by it. Thus, the *electric field due to a charge Q at a point in space may be defined as the force that a unit positive charge would experience if placed*

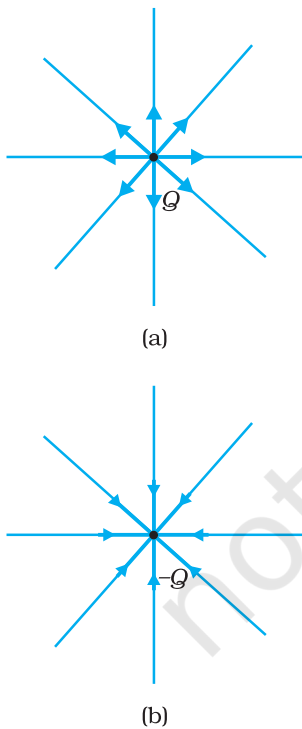

FIGURE 1.8 Electric field (a) due to a charge Q , (b) due to a charge $-Q$.

* An alternate unit V/m will be introduced in the next chapter.

at that point. The charge Q , which is producing the electric field, is called a *source charge* and the charge q , which tests the effect of a source charge, is called a *test charge*. Note that the source charge Q must remain at its original location. However, if a charge q is brought at any point around Q , Q itself is bound to experience an electrical force due to q and will tend to move. A way out of this difficulty is to make q negligibly small. The force \mathbf{F} is then negligibly small but the ratio \mathbf{F}/q is finite and defines the electric field:

$$\mathbf{E} = \lim_{q \rightarrow 0} \left(\frac{\mathbf{F}}{q} \right) \quad (1.9)$$

A practical way to get around the problem (of keeping Q undisturbed in the presence of q) is to hold Q to its location by unspecified forces! This may look strange but actually this is what happens in practice. When we are considering the electric force on a test charge q due to a charged planar sheet (Section 1.14), the charges on the sheet are held to their locations by the forces due to the unspecified charged constituents inside the sheet.

- (ii) Note that the electric field \mathbf{E} due to Q , though defined operationally in terms of some test charge q , is independent of q . This is because \mathbf{F} is proportional to q , so the ratio \mathbf{F}/q does not depend on q . The force \mathbf{F} on the charge q due to the charge Q depends on the particular location of charge q which may take any value in the space around the charge Q . Thus, the electric field \mathbf{E} due to Q is also dependent on the space coordinate \mathbf{r} . For different positions of the charge q all over the space, we get different values of electric field \mathbf{E} . The field exists at every point in three-dimensional space.
- (iii) For a positive charge, the electric field will be directed radially outwards from the charge. On the other hand, if the source charge is negative, the electric field vector, at each point, points radially inwards.
- (iv) Since the magnitude of the force \mathbf{F} on charge q due to charge Q depends only on the distance r of the charge q from charge Q , the magnitude of the electric field \mathbf{E} will also depend only on the distance r . Thus at equal distances from the charge Q , the magnitude of its electric field \mathbf{E} is same. The magnitude of electric field \mathbf{E} due to a point charge is thus same on a sphere with the point charge at its centre; in other words, it has a spherical symmetry.

1.7.1 Electric field due to a system of charges

Consider a system of charges q_1, q_2, \dots, q_n with position vectors $\mathbf{r}_1, \mathbf{r}_2, \dots, \mathbf{r}_n$ relative to some origin O . Like the electric field at a point in space due to a single charge, electric field at a point in space due to the system of charges is defined to be the force experienced by a unit test charge placed at that point, without disturbing the original positions of charges q_1, q_2, \dots, q_n . We can use Coulomb's law and the superposition principle to determine this field at a point P denoted by position vector \mathbf{r} .

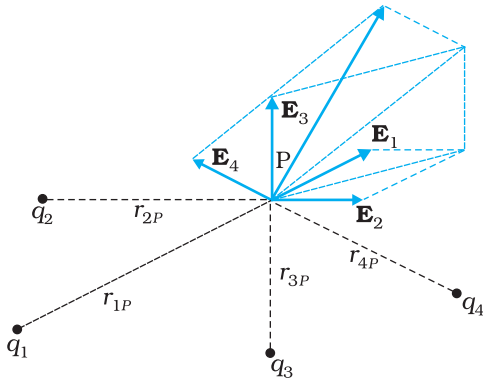

FIGURE 1.9 Electric field at a point due to a system of charges is the vector sum of the electric fields at the point due to individual charges.

Electric field \mathbf{E}_1 at \mathbf{r} due to q_1 at \mathbf{r}_1 is given by

$$\mathbf{E}_1 = \frac{1}{4\pi\epsilon_0} \frac{q_1}{r_{1P}^2} \hat{\mathbf{r}}_{1P}$$

where $\hat{\mathbf{r}}_{1P}$ is a unit vector in the direction from q_1 to P, and r_{1P} is the distance between q_1 and P. In the same manner, electric field \mathbf{E}_2 at \mathbf{r} due to q_2 at \mathbf{r}_2 is

$$\mathbf{E}_2 = \frac{1}{4\pi\epsilon_0} \frac{q_2}{r_{2P}^2} \hat{\mathbf{r}}_{2P}$$

where $\hat{\mathbf{r}}_{2P}$ is a unit vector in the direction from q_2 to P and r_{2P} is the distance between q_2 and P. Similar expressions hold good for fields $\mathbf{E}_3, \mathbf{E}_4, \dots, \mathbf{E}_n$ due to charges q_3, q_4, \dots, q_n .

By the superposition principle, the electric field \mathbf{E} at \mathbf{r} due to the system of charges is (as shown in Fig. 1.9)

$$\mathbf{E}(\mathbf{r}) = \mathbf{E}_1(\mathbf{r}) + \mathbf{E}_2(\mathbf{r}) + \dots + \mathbf{E}_n(\mathbf{r})$$

$$= \frac{1}{4\pi\epsilon_0} \frac{q_1}{r_{1P}^2} \hat{\mathbf{r}}_{1P} + \frac{1}{4\pi\epsilon_0} \frac{q_2}{r_{2P}^2} \hat{\mathbf{r}}_{2P} + \dots + \frac{1}{4\pi\epsilon_0} \frac{q_n}{r_{nP}^2} \hat{\mathbf{r}}_{nP}$$

$$\mathbf{E}(\mathbf{r}) = \frac{1}{4\pi\epsilon_0} \sum_{i=1}^n \frac{q_i}{r_{iP}^2} \hat{\mathbf{r}}_{iP} \quad (1.10)$$

\mathbf{E} is a vector quantity that varies from one point to another point in space and is determined from the positions of the source charges.

1.7.2 Physical significance of electric field

You may wonder why the notion of electric field has been introduced here at all. After all, for any system of charges, the measurable quantity is the force on a charge which can be directly determined using Coulomb's law and the superposition principle [Eq. (1.5)]. Why then introduce this intermediate quantity called the electric field?

For electrostatics, the concept of electric field is convenient, but not really necessary. Electric field is an elegant way of characterising the electrical environment of a system of charges. Electric field at a point in the space around a system of charges tells you the force a unit positive test charge would experience if placed at that point (without disturbing the system). Electric field is a characteristic of the system of charges and is independent of the test charge that you place at a point to determine the field. The term *field* in physics generally refers to a quantity that is defined at every point in space and may vary from point to point. Electric field is a vector field, since force is a vector quantity.

The true physical significance of the concept of electric field, however, emerges only when we go beyond electrostatics and deal with time-dependent electromagnetic phenomena. Suppose we consider the force between two distant charges q_1, q_2 in accelerated motion. Now the greatest speed with which a signal or information can go from one point to another is c , the speed of light. Thus, the effect of any motion of q_1 on q_2 cannot

arise instantaneously. There will be some time delay between the effect (force on q_2) and the cause (motion of q_1). It is precisely here that the notion of electric field (strictly, electromagnetic field) is natural and very useful. *The field picture is this: the accelerated motion of charge q_1 produces electromagnetic waves, which then propagate with the speed c , reach q_2 and cause a force on q_2 .* The notion of field elegantly accounts for the time delay. Thus, even though electric and magnetic fields can be detected only by their effects (forces) on charges, they are regarded as physical entities, not merely mathematical constructs. They have an *independent dynamics* of their own, i.e., they evolve according to laws of their *own*. They can also transport energy. Thus, a source of time-dependent electromagnetic fields, turned on for a short interval of time and then switched off, leaves behind propagating electromagnetic fields transporting energy. The concept of field was first introduced by Faraday and is now among the central concepts in physics.

Example 1.7 An electron falls through a distance of 1.5 cm in a uniform electric field of magnitude $2.0 \times 10^4 \text{ N C}^{-1}$ [Fig. 1.10(a)]. The direction of the field is reversed keeping its magnitude unchanged and a proton falls through the same distance [Fig. 1.10(b)]. Compute the time of fall in each case. Contrast the situation with that of 'free fall under gravity'.

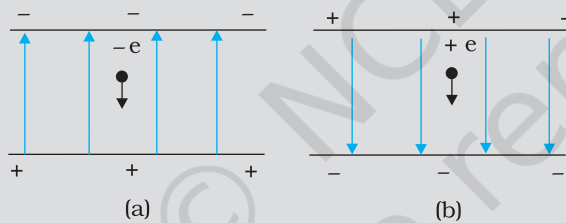

FIGURE 1.10

Solution In Fig. 1.10(a) the field is upward, so the negatively charged electron experiences a downward force of magnitude eE where E is the magnitude of the electric field. The acceleration of the electron is

$$a_e = eE/m_e$$

where m_e is the mass of the electron.

Starting from rest, the time required by the electron to fall through a

distance h is given by $t_e = \sqrt{\frac{2h}{a_e}} = \sqrt{\frac{2hm_e}{eE}}$

For $e = 1.6 \times 10^{-19} \text{ C}$, $m_e = 9.11 \times 10^{-31} \text{ kg}$,

$$E = 2.0 \times 10^4 \text{ N C}^{-1}, h = 1.5 \times 10^{-2} \text{ m},$$

$$t_e = 2.9 \times 10^{-9} \text{ s}$$

In Fig. 1.10 (b), the field is downward, and the positively charged proton experiences a downward force of magnitude eE . The acceleration of the proton is

$$a_p = eE/m_p$$

where m_p is the mass of the proton; $m_p = 1.67 \times 10^{-27} \text{ kg}$. The time of fall for the proton is

$$t_p = \sqrt{\frac{2h}{a_p}} = \sqrt{\frac{2hm_p}{eE}} = 1.3 \times 10^{-7} \text{ s}$$

Thus, the heavier particle (proton) takes a greater time to fall through the same distance. This is in basic contrast to the situation of 'free fall under gravity' where the time of fall is independent of the mass of the body. Note that in this example we have ignored the acceleration due to gravity in calculating the time of fall. To see if this is justified, let us calculate the acceleration of the proton in the given electric field:

$$a_p = \frac{eE}{m_p} = \frac{(1.6 \times 10^{-19} \text{ C}) \times (2.0 \times 10^4 \text{ N C}^{-1})}{1.67 \times 10^{-27} \text{ kg}} = 1.9 \times 10^{12} \text{ m s}^{-2}$$

which is enormous compared to the value of g (9.8 m s^{-2}), the acceleration due to gravity. The acceleration of the electron is even greater. Thus, the effect of acceleration due to gravity can be ignored in this example.

Example 1.8 Two point charges q_1 and q_2 , of magnitude $+10^{-8} \text{ C}$ and -10^{-8} C , respectively, are placed 0.1 m apart. Calculate the electric fields at points A, B and C shown in Fig. 1.11.

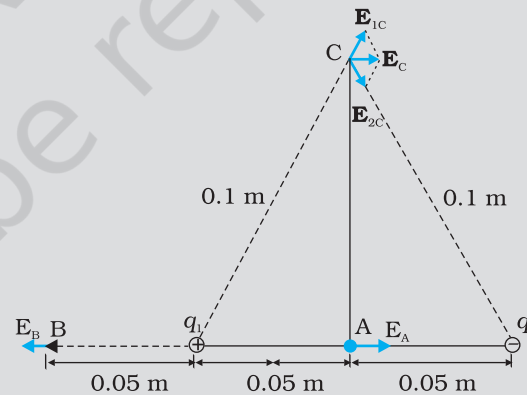

FIGURE 1.11

Solution The electric field vector \mathbf{E}_{1A} at A due to the positive charge q_1 points towards the right and has a magnitude

$$E_{1A} = \frac{(9 \times 10^9 \text{ Nm}^2\text{C}^{-2}) \times (10^{-8} \text{ C})}{(0.05 \text{ m})^2} = 3.6 \times 10^4 \text{ N C}^{-1}$$

The electric field vector \mathbf{E}_{2A} at A due to the negative charge q_2 points towards the right and has the same magnitude. Hence the magnitude of the total electric field E_A at A is

$$E_A = E_{1A} + E_{2A} = 7.2 \times 10^4 \text{ N C}^{-1}$$

\mathbf{E}_A is directed toward the right.

The electric field vector \mathbf{E}_{1B} at B due to the positive charge q_1 points towards the left and has a magnitude

$$E_{1B} = \frac{(9 \times 10^9 \text{ Nm}^2 \text{ C}^{-2}) \times (10^{-8} \text{ C})}{(0.05 \text{ m})^2} = 3.6 \times 10^4 \text{ N C}^{-1}$$

The electric field vector \mathbf{E}_{2B} at B due to the negative charge q_2 points towards the right and has a magnitude

$$E_{2B} = \frac{(9 \times 10^9 \text{ Nm}^2 \text{ C}^{-2}) \times (10^{-8} \text{ C})}{(0.15 \text{ m})^2} = 4 \times 10^3 \text{ N C}^{-1}$$

The magnitude of the total electric field at B is

$$E_B = E_{1B} - E_{2B} = 3.2 \times 10^4 \text{ N C}^{-1}$$

\mathbf{E}_B is directed towards the left.

The magnitude of each electric field vector at point C, due to charge q_1 and q_2 is

$$E_{1C} = E_{2C} = \frac{(9 \times 10^9 \text{ Nm}^2 \text{ C}^{-2}) \times (10^{-8} \text{ C})}{(0.10 \text{ m})^2} = 9 \times 10^3 \text{ N C}^{-1}$$

The directions in which these two vectors point are indicated in Fig. 1.11. The resultant of these two vectors is

$$E_C = E_{1C} \cos \frac{\pi}{3} + E_{2C} \cos \frac{\pi}{3} = 9 \times 10^3 \text{ N C}^{-1}$$

\mathbf{E}_C points towards the right.

EXAMPLE 1.8

1.8 ELECTRIC FIELD LINES

We have studied electric field in the last section. It is a vector quantity and can be represented as we represent vectors. Let us try to represent \mathbf{E} due to a point charge pictorially. Let the point charge be placed at the origin. Draw vectors pointing along the direction of the electric field with their lengths proportional to the strength of the field at each point. Since the magnitude of electric field at a point decreases inversely as the square of the distance of that point from the charge, the vector gets shorter as one goes away from the origin, always pointing radially outward. Figure 1.12 shows such a picture. In this figure, each arrow indicates the electric field, i.e., the force acting on a unit positive charge, placed at the tail of that arrow. Connect the arrows pointing in one direction and the resulting figure represents a field line. We thus get many field lines, all pointing outwards from the point charge. Have we lost the information about the strength or magnitude of the field now, because it was contained in the length of the arrow? No. Now the magnitude of the field is represented by the density of field lines. \mathbf{E} is strong near the charge, so the density of field lines is more near the charge and the lines are closer. Away from the charge, the field gets weaker and the density of field lines is less, resulting in well-separated lines.

Another person may draw more lines. But the number of lines is not important. In fact, an infinite number of lines can be drawn in any region.

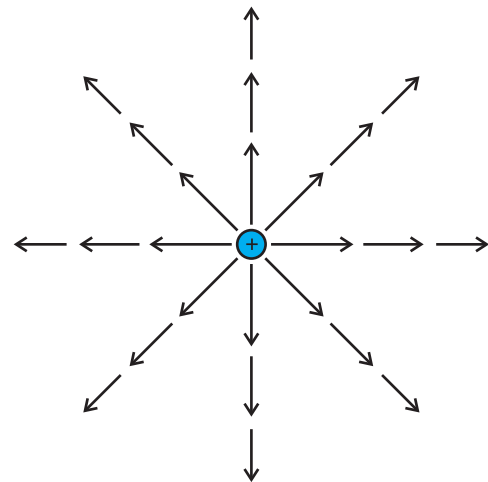

FIGURE 1.12 Field of a point charge.

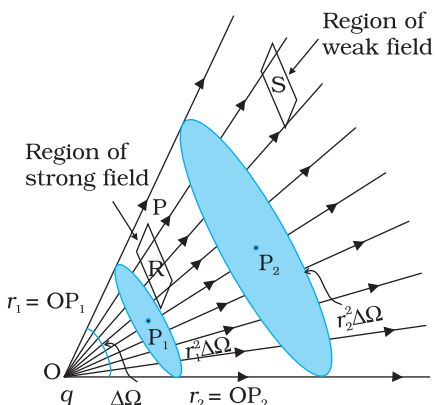

FIGURE 1.13 Dependence of electric field strength on the distance and its relation to the number of field lines.

It is the relative density of lines in different regions which is important.

We draw the figure on the plane of paper, *i.e.*, in two-dimensions but we live in three-dimensions. So if one wishes to estimate the density of field lines, one has to consider the number of lines per unit cross-sectional area, perpendicular to the lines. Since the electric field decreases as the square of the distance from a point charge and the area enclosing the charge increases as the square of the distance, the number of field lines crossing the enclosing area remains constant, whatever may be the distance of the area from the charge.

We started by saying that the field lines carry information about the direction of electric field at different points in space. Having drawn a certain set of field lines, the relative density (i.e., closeness) of the field lines at different points indicates the relative strength of electric field at those points. The field lines crowd where the field is strong and are spaced apart where it is weak. Figure 1.13 shows a set of field lines. We

can imagine two equal and small elements of area placed at points R and S normal to the field lines there. The number of field lines in our picture cutting the area elements is proportional to the magnitude of field at these points. The picture shows that the field at R is stronger than at S.

To understand the dependence of the field lines on the area, or rather the *solid angle* subtended by an area element, let us try to relate the area with the solid angle, a generalisation of angle to three dimensions. Recall how a (plane) angle is defined in two-dimensions. Let a small transverse line element Δl be placed at a distance r from a point O. Then the angle subtended by Δl at O can be approximated as $\Delta\theta = \Delta l/r$. Likewise, in three-dimensions the solid angle* subtended by a small perpendicular plane area ΔS , at a distance r , can be written as $\Delta\Omega = \Delta S/r^2$. We know that in a given solid angle the number of radial field lines is the same. In Fig. 1.13, for two points P_1 and P_2 at distances r_1 and r_2 from the charge, the element of area subtending the solid angle $\Delta\Omega$ is $r_1^2 \Delta\Omega$ at P_1 and an element of area $r_2^2 \Delta\Omega$ at P_2 , respectively. The number of lines (say n) cutting these area elements are the same. The number of field lines, cutting unit area element is therefore $n/(r_1^2 \Delta\Omega)$ at P_1 and $n/(r_2^2 \Delta\Omega)$ at P_2 , respectively. Since n and $\Delta\Omega$ are common, the strength of the field clearly has a $1/r^2$ dependence.

The picture of field lines was invented by Faraday to develop an intuitive non-mathematical way of visualising electric fields around charged configurations. Faraday called them *lines of force*. *This term is somewhat misleading, especially in case of magnetic fields. The more appropriate term is field lines (electric or magnetic) that we have adopted in this book.*

Electric field lines are thus a way of pictorially mapping the electric field around a configuration of charges. An electric field line is, in general,

* Solid angle is a measure of a cone. Consider the intersection of the given cone with a sphere of radius R . The solid angle $\Delta\Omega$ of the cone is defined to be equal to $\Delta S/R^2$, where ΔS is the area on the sphere cut out by the cone.

a curve drawn in such a way that the tangent to it at each point is in the direction of the net field at that point. An arrow on the curve is obviously necessary to specify the direction of electric field from the two possible directions indicated by a tangent to the curve. A field line is a space curve, i.e., a curve in three dimensions.

Figure 1.14 shows the field lines around some simple charge configurations. As mentioned earlier, the field lines are in 3-dimensional space, though the figure shows them only in a plane. The field lines of a single positive charge are radially outward while those of a single negative charge are radially inward. The field lines around a system of two positive charges (q, q) give a vivid pictorial description of their mutual repulsion, while those around the configuration of two equal and opposite charges ($q, -q$), a dipole, show clearly the mutual attraction between the charges. The field lines follow some important general properties:

- (i) Field lines start from positive charges and end at negative charges. If there is a single charge, they may start or end at infinity.
- (ii) In a charge-free region, electric field lines can be taken to be continuous curves without any breaks.
- (iii) Two field lines can never cross each other. (If they did, the field at the point of intersection will not have a unique direction, which is absurd.)
- (iv) Electrostatic field lines do not form any closed loops. This follows from the conservative nature of electric field (Chapter 2).

1.9 ELECTRIC FLUX

Consider flow of a liquid with velocity \mathbf{v} , through a small flat surface dS , in a direction normal to the surface. The rate of flow of liquid is given by the volume crossing the area per unit time $v dS$ and represents the flux of liquid flowing across the plane. If the normal to the surface is not parallel to the direction of flow of liquid, i.e., to \mathbf{v} , but makes an angle θ with it, the projected area in a plane perpendicular to \mathbf{v} is $\delta dS \cos \theta$. Therefore, the flux going out of the surface dS is $\mathbf{v} \cdot \hat{\mathbf{n}} dS$. For the case of the electric field, we define an analogous quantity and call it *electric flux*. We should, however, note that there is no *flow* of a physically observable quantity unlike the case of liquid flow.

In the picture of electric field lines described above, we saw that the number of field lines crossing a unit area, placed normal to the field at a point is a measure of the strength of electric field at that point. This means that if

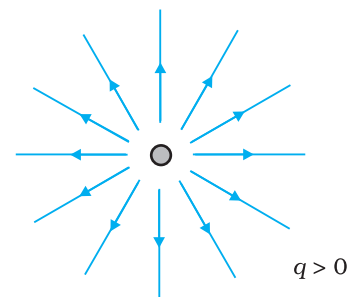

(a)

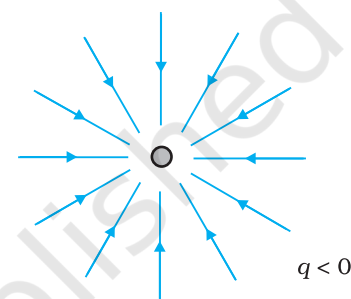

(b)

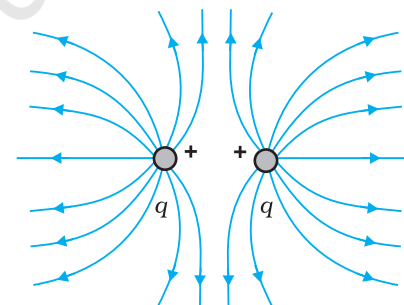

(c)

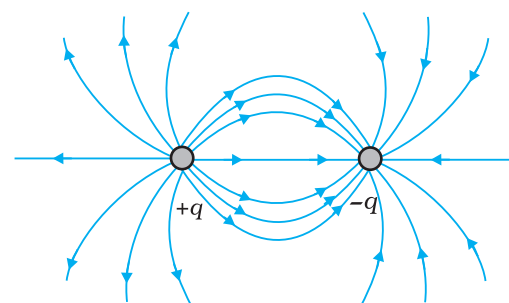

(d)

FIGURE 1.14 Field lines due to some simple charge configurations.

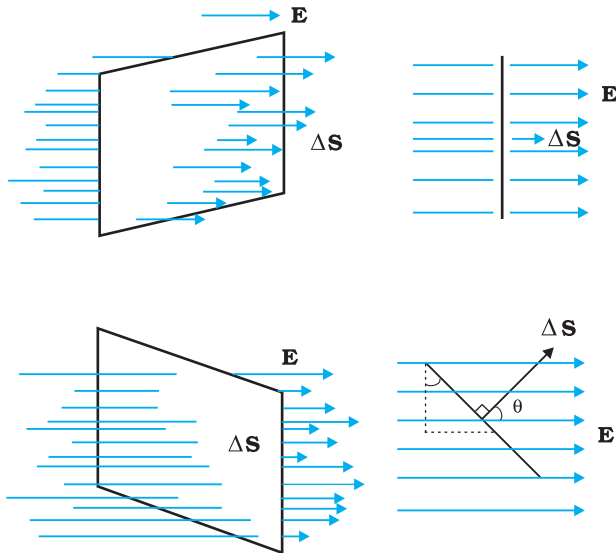

FIGURE 1.15 Dependence of flux on the inclination θ between \mathbf{E} and $\hat{\mathbf{n}}$.

we place a small planar element of area ΔS normal to \mathbf{E} at a point, the number of field lines crossing it is proportional* to $E \Delta S$. Now suppose we tilt the area element by angle θ . Clearly, the number of field lines crossing the area element will be smaller. The projection of the area element normal to E is $\Delta S \cos \theta$. Thus, the number of field lines crossing ΔS is proportional to $E \Delta S \cos \theta$. When $\theta = 90^\circ$, field lines will be parallel to ΔS and will not cross it at all (Fig. 1.15).

The orientation of area element and not merely its magnitude is important in many contexts. For example, in a stream, the amount of water flowing through a ring will naturally depend on how you hold the ring. If you hold it normal to the flow, maximum water will flow through it than if you hold it with some other orientation. This shows that an area element should be treated as a vector. It has a

magnitude and also a direction. How to specify the direction of a planar area? Clearly, the normal to the plane specifies the orientation of the plane. Thus the direction of a planar area vector is along its normal.

How to associate a vector to the area of a curved surface? We imagine dividing the surface into a large number of very small area elements. Each small area element may be treated as planar and a vector associated with it, as explained before.

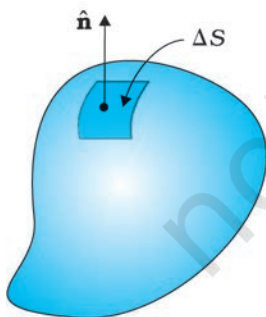
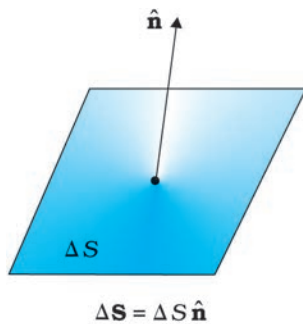

FIGURE 1.16 Convention for defining normal $\hat{\mathbf{n}}$ and $\Delta \mathbf{S}$.

Notice one ambiguity here. The direction of an area element is along its normal. But a normal can point in two directions. Which direction do we choose as the direction of the vector associated with the area element? This problem is resolved by some convention appropriate to the given context. For the case of a closed surface, this convention is very simple. The vector associated with every area element of a closed surface is taken to be in the direction of the *outward* normal. This is the convention used in Fig. 1.16. Thus, the area element vector $\Delta \mathbf{S}$ at a point on a closed surface equals $\Delta S \hat{\mathbf{n}}$ where ΔS is the magnitude of the area element and $\hat{\mathbf{n}}$ is a unit vector in the direction of outward normal at that point.

We now come to the definition of electric flux. Electric flux $\Delta \phi$ through an area element $\Delta \mathbf{S}$ is defined by

$$\Delta \phi = \mathbf{E} \cdot \Delta \mathbf{S} = E \Delta S \cos \theta \quad (1.11)$$

which, as seen before, is proportional to the number of field lines cutting the area element. The angle θ here is the angle between \mathbf{E} and $\Delta \mathbf{S}$. For a closed surface, with the convention stated already, θ is the angle between \mathbf{E} and the outward normal to the area element. Notice we could look at the expression $E \Delta S \cos \theta$ in two ways: $E (\Delta S \cos \theta)$ i.e., E times the

* It will not be proper to say that the number of field lines is equal to $E \Delta S$. The number of field lines is after all, a matter of how many field lines we choose to draw. What is physically significant is the relative number of field lines crossing a given area at different points.

projection of area normal to \mathbf{E} , or $E_{\perp} \Delta S$, i.e., component of \mathbf{E} along the normal to the area element times the magnitude of the area element. The unit of electric flux is $\text{N C}^{-1} \text{m}^2$.

The basic definition of electric flux given by Eq. (1.11) can be used, in principle, to calculate the total flux through any given surface. All we have to do is to divide the surface into small area elements, calculate the flux at each element and add them up. Thus, the total flux ϕ through a surface S is

$$\phi \simeq \sum \mathbf{E} \cdot \Delta \mathbf{S} \quad (1.12)$$

The approximation sign is put because the electric field \mathbf{E} is taken to be constant over the small area element. This is mathematically exact only when you take the limit $\Delta S \rightarrow 0$ and the sum in Eq. (1.12) is written as an integral.

1.10 ELECTRIC DIPOLE

An electric dipole is a pair of equal and opposite point charges q and $-q$, separated by a distance $2a$. The line connecting the two charges defines a direction in space. By convention, the direction from $-q$ to q is said to be the direction of the dipole. The mid-point of locations of $-q$ and q is called the centre of the dipole.

The total charge of the electric dipole is obviously zero. This does not mean that the field of the electric dipole is zero. Since the charge q and $-q$ are separated by some distance, the electric fields due to them, when added, do not exactly cancel out. However, at distances much larger than the separation of the two charges forming a dipole ($r \gg 2a$), the fields due to q and $-q$ nearly cancel out. The electric field due to a dipole therefore falls off, at large distance, faster than like $1/r^2$ (the dependence on r of the field due to a single charge q). These qualitative ideas are borne out by the explicit calculation as follows:

1.10.1 The field of an electric dipole

The electric field of the pair of charges ($-q$ and q) at any point in space can be found out from Coulomb's law and the superposition principle. The results are simple for the following two cases: (i) when the point is on the dipole axis, and (ii) when it is in the *equatorial plane* of the dipole, i.e., on a plane perpendicular to the dipole axis through its centre. The electric field at any general point P is obtained by adding the electric fields \mathbf{E}_{-q} due to the charge $-q$ and \mathbf{E}_{+q} due to the charge q , by the parallelogram law of vectors.

(i) For points on the axis

Let the point P be at distance r from the centre of the dipole on the side of the charge q , as shown in Fig. 1.17(a). Then

$$\mathbf{E}_{-q} = -\frac{q}{4\pi\epsilon_0(r+a)^2} \mathbf{p} \quad [1.13(a)]$$

where $\hat{\mathbf{p}}$ is the unit vector along the dipole axis (from $-q$ to q). Also

$$\mathbf{E}_{+q} = \frac{q}{4\pi\epsilon_0(r-a)^2} \mathbf{p} \quad [1.13(b)]$$

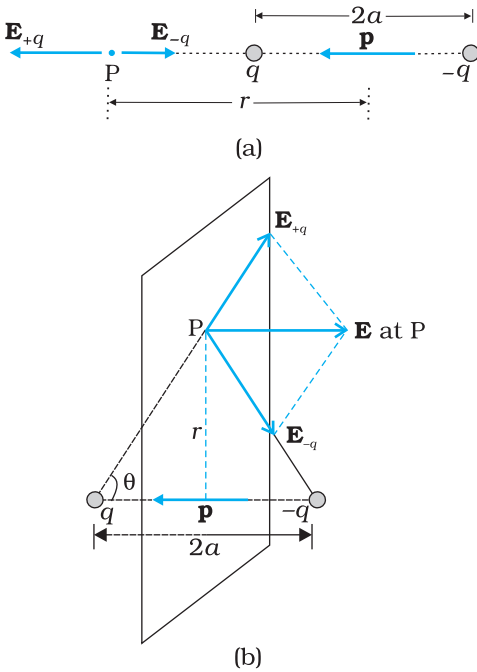

FIGURE 1.17 Electric field of a dipole at (a) a point on the axis, (b) a point on the equatorial plane of the dipole. \mathbf{p} is the dipole moment vector of magnitude $p = q \times 2a$ and directed from $-q$ to q .

The total field at P is

$$\begin{aligned} \mathbf{E} &= \mathbf{E}_{+q} + \mathbf{E}_{-q} = \frac{q}{4\pi\epsilon_0} \left[\frac{1}{(r-a)^2} - \frac{1}{(r+a)^2} \right] \mathbf{P} \\ &= \frac{q}{4\pi\epsilon_0} \frac{4ar}{(r^2 - a^2)^2} \mathbf{P} \end{aligned} \quad (1.14)$$

For $r \gg a$

$$\mathbf{E} = \frac{4qa}{4\pi\epsilon_0 r^3} \hat{\mathbf{p}} \quad (r \gg a) \quad (1.15)$$

(ii) For points on the equatorial plane

The magnitudes of the electric fields due to the two charges $+q$ and $-q$ are given by

$$E_{+q} = \frac{q}{4\pi\epsilon_0} \frac{1}{r^2 + a^2} \quad (1.16(a))$$

$$E_{-q} = \frac{q}{4\pi\epsilon_0} \frac{1}{r^2 + a^2} \quad (1.16(b))$$

and are equal.

The directions of \mathbf{E}_{+q} and \mathbf{E}_{-q} are as shown in Fig. 1.17(b). Clearly, the components normal to the dipole axis cancel away. The components along the dipole axis add up. The total electric field is opposite to $\hat{\mathbf{p}}$. We have

$$\begin{aligned} \mathbf{E} &= -(E_{+q} + E_{-q}) \cos\theta \hat{\mathbf{p}} \\ &= -\frac{2qa}{4\pi\epsilon_0 (r^2 + a^2)^{3/2}} \mathbf{P} \end{aligned} \quad (1.17)$$

At large distances ($r \gg a$), this reduces to

$$\mathbf{E} = -\frac{2qa}{4\pi\epsilon_0 r^3} \hat{\mathbf{p}} \quad (r \gg a) \quad (1.18)$$

From Eqs. (1.15) and (1.18), it is clear that the dipole field at large distances does not involve q and a separately; it depends on the product qa . This suggests the definition of dipole moment. The *dipole moment vector* \mathbf{p} of an electric dipole is defined by

$$\mathbf{p} = q \times 2a \hat{\mathbf{p}} \quad (1.19)$$

that is, it is a vector whose magnitude is charge q times the separation $2a$ (between the pair of charges $q, -q$) and the direction is along the line from $-q$ to q . In terms of \mathbf{p} , the electric field of a dipole at large distances takes simple forms:

At a point on the dipole axis

$$\mathbf{E} = \frac{2\mathbf{p}}{4\pi\epsilon_0 r^3} \quad (r \gg a) \quad (1.20)$$

At a point on the equatorial plane

$$\mathbf{E} = -\frac{\mathbf{p}}{4\pi\epsilon_0 r^3} \quad (r \gg a) \quad (1.21)$$

Notice the important point that the dipole field at large distances falls off not as $1/r^2$ but as $1/r^3$. Further, the magnitude and the direction of the dipole field depends not only on the distance r but also on the *angle* between the position vector \mathbf{r} and the dipole moment \mathbf{p} .

We can think of the limit when the dipole size $2a$ approaches zero, the charge q approaches infinity in such a way that the product $p = q \times 2a$ is finite. Such a dipole is referred to as a *point dipole*. For a point dipole, Eqs. (1.20) and (1.21) are exact, true for any r .

1.10.2 Physical significance of dipoles

In most molecules, the centres of positive charges and of negative charges* lie at the same place. Therefore, their dipole moment is zero. CO_2 and CH_4 are of this type of molecules. However, they develop a dipole moment when an electric field is applied. But in some molecules, the centres of negative charges and of positive charges do not coincide. Therefore they have a permanent electric dipole moment, even in the absence of an electric field. Such molecules are called polar molecules. Water molecules, H_2O , is an example of this type. Various materials give rise to interesting properties and important applications in the presence or absence of electric field.

Example 1.9 Two charges $\pm 10 \mu\text{C}$ are placed 5.0 mm apart. Determine the electric field at (a) a point P on the axis of the dipole 15 cm away from its centre O on the side of the positive charge, as shown in Fig. 1.18(a), and (b) a point Q, 15 cm away from O on a line passing through O and normal to the axis of the dipole, as shown in Fig. 1.18(b).

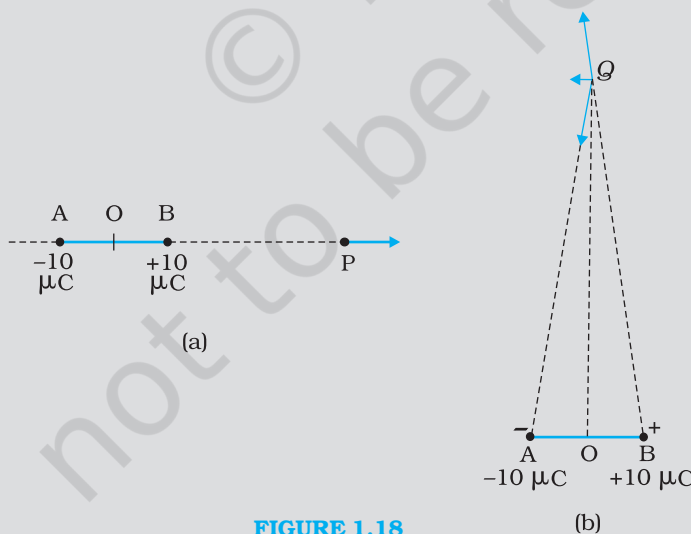

FIGURE 1.18

EXAMPLE 1.9

* Centre of a collection of positive point charges is defined much the same way

as the centre of mass:
$$\mathbf{r}_{\text{cm}} = \frac{\sum_i q_i \mathbf{r}_i}{\sum_i q_i}$$

Solution (a) Field at P due to charge $+10 \mu\text{C}$

$$= \frac{10^{-5} \text{ C}}{4\pi(8.854 \times 10^{-12} \text{ C}^2 \text{ N}^{-1} \text{ m}^{-2})} \times \frac{1}{(15 - 0.25)^2 \times 10^{-4} \text{ m}^2}$$

$$= 4.13 \times 10^6 \text{ N C}^{-1} \text{ along BP}$$

Field at P due to charge $-10 \mu\text{C}$

$$= \frac{10^{-5} \text{ C}}{4\pi(8.854 \times 10^{-12} \text{ C}^2 \text{ N}^{-1} \text{ m}^{-2})} \times \frac{1}{(15 + 0.25)^2 \times 10^{-4} \text{ m}^2}$$

$$= 3.86 \times 10^6 \text{ N C}^{-1} \text{ along PA}$$

The resultant electric field at P due to the two charges at A and B is

$$= 2.7 \times 10^5 \text{ N C}^{-1} \text{ along BP.}$$

In this example, the ratio OP/OB is quite large ($= 60$). Thus, we can expect to get approximately the same result as above by directly using the formula for electric field at a far-away point on the axis of a dipole. For a dipole consisting of charges $\pm q$, $2a$ distance apart, the electric field at a distance r from the centre on the axis of the dipole has a magnitude

$$E = \frac{2p}{4\pi\epsilon_0 r^3} \quad (r/a \gg 1)$$

where $p = 2a q$ is the magnitude of the dipole moment.

The direction of electric field on the dipole axis is always along the direction of the dipole moment vector (i.e., from $-q$ to q). Here, $p = 10^{-5} \text{ C} \times 5 \times 10^{-3} \text{ m} = 5 \times 10^{-8} \text{ C m}$

Therefore,

$$E = \frac{2 \times 5 \times 10^{-8} \text{ C m}}{4\pi(8.854 \times 10^{-12} \text{ C}^2 \text{ N}^{-1} \text{ m}^{-2})} \times \frac{1}{(15)^3 \times 10^{-6} \text{ m}^3} = 2.6 \times 10^5 \text{ N C}^{-1}$$

along the dipole moment direction AB, which is close to the result obtained earlier.

(b) Field at Q due to charge $+10 \mu\text{C}$ at B

$$= \frac{10^{-5} \text{ C}}{4\pi(8.854 \times 10^{-12} \text{ C}^2 \text{ N}^{-1} \text{ m}^{-2})} \times \frac{1}{[15^2 + (0.25)^2] \times 10^{-4} \text{ m}^2}$$

$$= 3.99 \times 10^6 \text{ N C}^{-1} \text{ along BQ}$$

Field at Q due to charge $-10 \mu\text{C}$ at A

$$= \frac{10^{-5} \text{ C}}{4\pi(8.854 \times 10^{-12} \text{ C}^2 \text{ N}^{-1} \text{ m}^{-2})} \times \frac{1}{[15^2 + (0.25)^2] \times 10^{-4} \text{ m}^2}$$

$$= 3.99 \times 10^6 \text{ N C}^{-1} \text{ along QA.}$$

Clearly, the components of these two forces with equal magnitudes cancel along the direction OQ but add up along the direction parallel to BA. Therefore, the resultant electric field at Q due to the two charges at A and B is

$$= 2 \times \frac{0.25}{\sqrt{15^2 + (0.25)^2}} \times 3.99 \times 10^6 \text{ N C}^{-1} \text{ along BA}$$

$$= 1.33 \times 10^5 \text{ N C}^{-1} \text{ along BA.}$$

As in (a), we can expect to get approximately the same result by directly using the formula for dipole field at a point on the normal to the axis of the dipole:

$$E = \frac{p}{4\pi\epsilon_0 r^3} \quad (r/a \gg 1)$$

$$= \frac{5 \times 10^{-8} \text{ C m}}{4\pi(8.854 \times 10^{-12} \text{ C}^2 \text{ N}^{-1} \text{ m}^{-2})} \times \frac{1}{(15)^3 \times 10^{-6} \text{ m}^3}$$

$$= 1.33 \times 10^5 \text{ N C}^{-1}.$$

The direction of electric field in this case is opposite to the direction of the dipole moment vector. Again, the result agrees with that obtained before.

EXAMPLE 1.9

1.11 DIPOLE IN A UNIFORM EXTERNAL FIELD

Consider a permanent dipole of dipole moment \mathbf{p} in a uniform external field \mathbf{E} , as shown in Fig. 1.19. (By permanent dipole, we mean that \mathbf{p} exists irrespective of \mathbf{E} ; it has not been induced by \mathbf{E} .)

There is a force $q\mathbf{E}$ on q and a force $-q\mathbf{E}$ on $-q$. The net force on the dipole is zero, since \mathbf{E} is uniform. However, the charges are separated, so the forces act at different points, resulting in a torque on the dipole. When the net force is zero, the torque (couple) is independent of the origin. Its magnitude equals the magnitude of each force multiplied by the arm of the couple (perpendicular distance between the two antiparallel forces).

$$\begin{aligned} \text{Magnitude of torque} &= qE \times 2a \sin\theta \\ &= 2qaE \sin\theta \end{aligned}$$

Its direction is normal to the plane of the paper, coming out of it.

The magnitude of $\mathbf{p} \times \mathbf{E}$ is also $pE \sin\theta$ and its direction is normal to the plane of the paper, coming out of it. Thus,

$$\boldsymbol{\tau} = \mathbf{p} \times \mathbf{E} \quad (1.22)$$

This torque will tend to align the dipole with the field \mathbf{E} . When \mathbf{p} is aligned with \mathbf{E} , the torque is zero.

What happens if the field is not uniform? In that case, the net force will evidently be non-zero. In addition there will, in general, be a torque on the system as before. The general case is involved, so let us consider the simpler situations when \mathbf{p} is parallel to \mathbf{E} or antiparallel to \mathbf{E} . In either case, the net torque is zero, but there is a net force on the dipole if \mathbf{E} is not uniform.

Figure 1.20 is self-explanatory. It is easily seen that when \mathbf{p} is parallel to \mathbf{E} , the dipole has a net force in the direction of increasing field. When \mathbf{p} is antiparallel to \mathbf{E} , the net force on the dipole is in the direction of decreasing field. In general, the force depends on the orientation of \mathbf{p} with respect to \mathbf{E} .

This brings us to a common observation in frictional electricity. A comb run through dry hair attracts pieces of paper. The comb, as we know, acquires charge through friction. But the paper is not charged. What then explains the attractive force? Taking the clue from the preceding

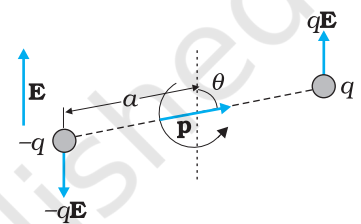
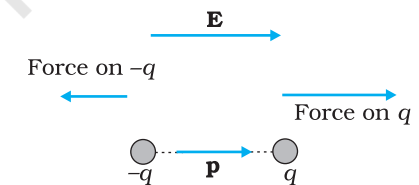
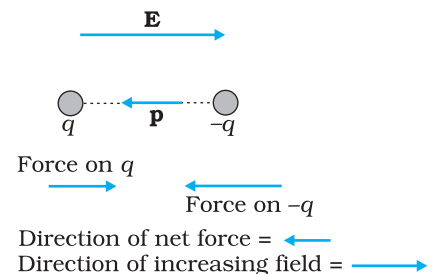

FIGURE 1.19 Dipole in a uniform electric field.



Direction of net force = \rightarrow
Direction of increasing field = \rightarrow

(a)



Direction of net force = \leftarrow
Direction of increasing field = \rightarrow

(b)

FIGURE 1.20 Electric force on a dipole: (a) \mathbf{E} parallel to \mathbf{p} , (b) \mathbf{E} antiparallel to \mathbf{p} .

discussion, the charged comb ‘polarises’ the piece of paper, i.e., induces a net dipole moment in the direction of field. Further, the electric field due to the comb is not uniform. This non-uniformity of the field makes a dipole to experience a net force on it. In this situation, it is easily seen that the paper should move in the direction of the comb!

1.12 CONTINUOUS CHARGE DISTRIBUTION

We have so far dealt with charge configurations involving discrete charges q_1, q_2, \dots, q_n . One reason why we restricted to discrete charges is that the mathematical treatment is simpler and does not involve calculus. For many purposes, however, it is impractical to work in terms of discrete charges and we need to work with continuous charge distributions. For example, on the surface of a charged conductor, it is impractical to specify the charge distribution in terms of the locations of the microscopic charged constituents. It is more feasible to consider an area element ΔS (Fig. 1.21) on the surface of the conductor (which is very small on the macroscopic scale but big enough to include a very large number of electrons) and specify the charge ΔQ on that element. We then define a *surface charge density* σ at the area element by

$$\sigma = \frac{\Delta Q}{\Delta S} \quad (1.23)$$

We can do this at different points on the conductor and thus arrive at a continuous function σ , called the surface charge density. The surface charge density σ so defined ignores the quantisation of charge and the discontinuity in charge distribution at the microscopic level*. σ represents macroscopic surface charge density, which in a sense, is a smoothed out average of the microscopic charge density over an area element ΔS which, as said before, is large microscopically but small macroscopically. The units for σ are C/m^2 .

Similar considerations apply for a line charge distribution and a volume charge distribution. The *linear charge density* λ of a wire is defined by

$$\lambda = \frac{\Delta Q}{\Delta l} \quad (1.24)$$

where Δl is a small line element of wire on the macroscopic scale that, however, includes a large number of microscopic charged constituents, and ΔQ is the charge contained in that line element. The units for λ are C/m . The *volume charge density* (sometimes simply called charge density) is defined in a similar manner:

$$\rho = \frac{\Delta Q}{\Delta V} \quad (1.25)$$

where ΔQ is the charge included in the macroscopically small volume element ΔV that includes a large number of microscopic charged constituents. The units for ρ are C/m^3 .

The notion of continuous charge distribution is similar to that we adopt for continuous mass distribution in mechanics. When we refer to

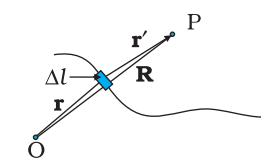

Line charge $\Delta Q = \lambda \Delta l$

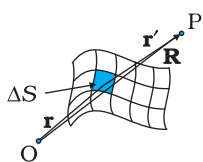

Surface charge $\Delta Q = \sigma \Delta S$

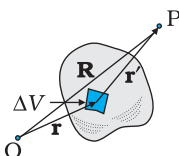

Volume charge $\Delta Q = \rho \Delta V$

FIGURE 1.21 Definition of linear, surface and volume charge densities. In each case, the element (Δl , ΔS , ΔV) chosen is small on the macroscopic scale but contains a very large number of microscopic constituents.

* At the microscopic level, charge distribution is discontinuous, because they are discrete charges separated by intervening space where there is no charge.

the density of a liquid, we are referring to its macroscopic density. We regard it as a continuous fluid and ignore its discrete molecular constitution.

The field due to a continuous charge distribution can be obtained in much the same way as for a system of discrete charges, Eq. (1.10). Suppose a continuous charge distribution in space has a charge density ρ . Choose any convenient origin O and let the position vector of any point in the charge distribution be \mathbf{r} . The charge density ρ may vary from point to point, i.e., it is a function of \mathbf{r} . Divide the charge distribution into small volume elements of size ΔV . The charge in a volume element ΔV is $\rho\Delta V$.

Now, consider any general point P (inside or outside the distribution) with position vector \mathbf{R} (Fig. 1.21). Electric field due to the charge $\rho\Delta V$ is given by Coulomb's law:

$$\Delta\mathbf{E} = \frac{1}{4\pi\epsilon_0} \frac{\rho \Delta V}{r'^2} \hat{\mathbf{r}}' \quad (1.26)$$

where r' is the distance between the charge element and P, and $\hat{\mathbf{r}}'$ is a unit vector in the direction from the charge element to P. By the superposition principle, the total electric field due to the charge distribution is obtained by summing over electric fields due to different volume elements:

$$\mathbf{E} \equiv \frac{1}{4\pi\epsilon_0} \sum_{\text{all } \Delta V} \frac{\rho \Delta V}{r'^2} \hat{\mathbf{r}}' \quad (1.27)$$

Note that ρ , r' , $\hat{\mathbf{r}}'$ all can vary from point to point. In a strict mathematical method, we should let $\Delta V \rightarrow 0$ and the sum then becomes an integral; but we omit that discussion here, for simplicity. In short, using Coulomb's law and the superposition principle, electric field can be determined for any charge distribution, discrete or continuous or part discrete and part continuous.

1.13 GAUSS'S LAW

As a simple application of the notion of electric flux, let us consider the total flux through a sphere of radius r , which encloses a point charge q at its centre. Divide the sphere into small area elements, as shown in Fig. 1.22.

The flux through an area element $\Delta\mathbf{S}$ is

$$\Delta\phi = \mathbf{E} \cdot \Delta\mathbf{S} = \frac{q}{4\pi\epsilon_0 r^2} \hat{\mathbf{r}} \cdot \Delta\mathbf{S} \quad (1.28)$$

where we have used Coulomb's law for the electric field due to a single charge q . The unit vector $\hat{\mathbf{r}}$ is along the radius vector from the centre to the area element. Now, since the normal to a sphere at every point is along the radius vector at that point, the area element $\Delta\mathbf{S}$ and $\hat{\mathbf{r}}$ have the same direction. Therefore,

$$\Delta\phi = \frac{q}{4\pi\epsilon_0 r^2} \Delta S \quad (1.29)$$

since the magnitude of a unit vector is 1.

The total flux through the sphere is obtained by adding up flux through all the different area elements:

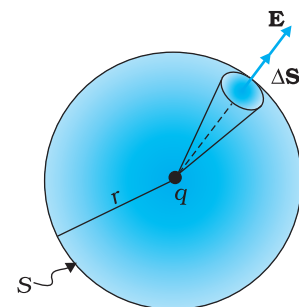

FIGURE 1.22 Flux through a sphere enclosing a point charge q at its centre.

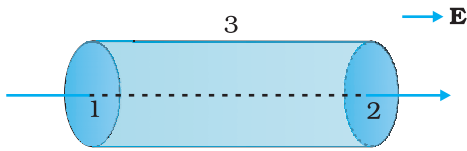

FIGURE 1.23 Calculation of the flux of uniform electric field through the surface of a cylinder.

$$\phi = \sum_{\text{all } \Delta S} \frac{q}{4\pi\epsilon_0 r^2} \Delta S$$

Since each area element of the sphere is at the same distance r from the charge,

$$\phi = \frac{q}{4\pi\epsilon_0 r^2} \sum_{\text{all } \Delta S} \Delta S = \frac{q}{4\pi\epsilon_0 r^2} S$$

Now S , the total area of the sphere, equals $4\pi r^2$. Thus,

$$\phi = \frac{q}{4\pi\epsilon_0 r^2} \times 4\pi r^2 = \frac{q}{\epsilon_0} \quad (1.30)$$

Equation (1.30) is a simple illustration of a general result of electrostatics called Gauss's law.

We state *Gauss's law* without proof:

Electric flux through a closed surface S

$$= q/\epsilon_0 \quad (1.31)$$

q = total charge enclosed by S .

The law implies that the total electric flux through a closed surface is zero if no charge is enclosed by the surface. We can see that explicitly in the simple situation of Fig. 1.23.

Here the electric field is uniform and we are considering a closed cylindrical surface, with its axis parallel to the uniform field \mathbf{E} . The total flux ϕ through the surface is $\phi = \phi_1 + \phi_2 + \phi_3$, where ϕ_1 and ϕ_2 represent the flux through the surfaces 1 and 2 (of circular cross-section) of the cylinder and ϕ_3 is the flux through the curved cylindrical part of the closed surface. Now the normal to the surface 3 at every point is perpendicular to \mathbf{E} , so by definition of flux, $\phi_3 = 0$. Further, the outward normal to 2 is along \mathbf{E} while the outward normal to 1 is opposite to \mathbf{E} . Therefore,

$$\begin{aligned} \phi_1 &= -E S_1, & \phi_2 &= +E S_2 \\ S_1 &= S_2 = S \end{aligned}$$

where S is the area of circular cross-section. Thus, the total flux is zero, as expected by Gauss's law. Thus, whenever you find that the net electric flux through a closed surface is zero, we conclude that the total charge contained in the closed surface is zero.

The great significance of Gauss's law Eq. (1.31), is that it is true in general, and not only for the simple cases we have considered above. Let us note some important points regarding this law:

- (i) Gauss's law is true for any closed surface, no matter what its shape or size.
- (ii) The term q on the right side of Gauss's law, Eq. (1.31), includes the sum of all charges enclosed by the surface. The charges may be located anywhere inside the surface.
- (iii) In the situation when the surface is so chosen that there are some charges inside and some outside, the electric field [whose flux appears on the left side of Eq. (1.31)] is due to all the charges, both inside and outside S . The term q on the right side of Gauss's law, however, represents only the total charge inside S .

- (iv) The surface that we choose for the application of Gauss's law is called the Gaussian surface. You may choose any Gaussian surface and apply Gauss's law. However, take care not to let the Gaussian surface pass through any discrete charge. This is because electric field due to a system of discrete charges is not well defined at the location of any charge. (As you go close to the charge, the field grows without any bound.) However, the Gaussian surface can pass through a continuous charge distribution.
- (v) Gauss's law is often useful towards a much easier calculation of the electrostatic field *when the system has some symmetry*. This is facilitated by the choice of a suitable Gaussian surface.
- (vi) Finally, Gauss's law is based on the inverse square dependence on distance contained in the Coulomb's law. Any violation of Gauss's law will indicate departure from the inverse square law.

Example 1.10 The electric field components in Fig. 1.24 are $E_x = \alpha x^{1/2}$, $E_y = E_z = 0$, in which $\alpha = 800 \text{ N/C m}^{1/2}$. Calculate (a) the flux through the cube, and (b) the charge within the cube. Assume that $a = 0.1 \text{ m}$.

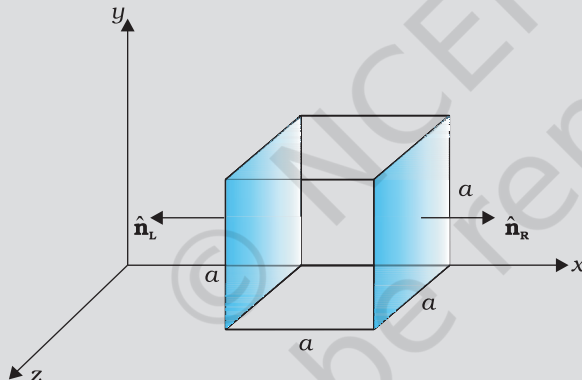

FIGURE 1.24

Solution

(a) Since the electric field has only an x component, for faces perpendicular to x direction, the angle between \mathbf{E} and $\Delta\mathbf{S}$ is $\pm \pi/2$. Therefore, the flux $\phi = \mathbf{E} \cdot \Delta\mathbf{S}$ is separately zero for each face of the cube except the two shaded ones. Now the magnitude of the electric field at the left face is

$$E_L = \alpha x^{1/2} = \alpha a^{1/2}$$

($x = a$ at the left face).

The magnitude of electric field at the right face is

$$E_R = \alpha x^{1/2} = \alpha (2a)^{1/2}$$

($x = 2a$ at the right face).

The corresponding fluxes are

$$\phi_L = \mathbf{E}_L \cdot \Delta\mathbf{S} = \Delta S \mathbf{E}_L \cdot \hat{\mathbf{n}}_L = E_L \Delta S \cos \theta = -E_L \Delta S, \text{ since } \theta = 180^\circ$$

$$= -E_L a^2$$

$$\phi_R = \mathbf{E}_R \cdot \Delta\mathbf{S} = E_R \Delta S \cos \theta = E_R \Delta S, \text{ since } \theta = 0^\circ$$

$$= E_R a^2$$

Net flux through the cube

$$\begin{aligned}
 &= \phi_R + \phi_L = E_R a^2 - E_L a^2 = a^2 (E_R - E_L) = \alpha a^2 [(2a)^{1/2} - a^{1/2}] \\
 &= \alpha a^{5/2} (\sqrt{2} - 1) \\
 &= 800 (0.1)^{5/2} (\sqrt{2} - 1) \\
 &= 1.05 \text{ N m}^2 \text{ C}^{-1}
 \end{aligned}$$

(b) We can use Gauss's law to find the total charge q inside the cube. We have $\phi = q/\epsilon_0$ or $q = \phi\epsilon_0$. Therefore,

$$q = 1.05 \times 8.854 \times 10^{-12} \text{ C} = 9.27 \times 10^{-12} \text{ C}.$$

Example 1.11 An electric field is uniform, and in the positive x direction for positive x , and uniform with the same magnitude but in the negative x direction for negative x . It is given that $\mathbf{E} = 200 \mathbf{i}$ N/C for $x > 0$ and $\mathbf{E} = -200 \mathbf{i}$ N/C for $x < 0$. A right circular cylinder of length 20 cm and radius 5 cm has its centre at the origin and its axis along the x -axis so that one face is at $x = +10$ cm and the other is at $x = -10$ cm (Fig. 1.25). (a) What is the net outward flux through each flat face? (b) What is the flux through the side of the cylinder? (c) What is the net outward flux through the cylinder? (d) What is the net charge inside the cylinder?

Solution

(a) We can see from the figure that on the left face \mathbf{E} and $\Delta\mathbf{S}$ are parallel. Therefore, the outward flux is

$$\begin{aligned}
 \phi_L &= \mathbf{E} \cdot \Delta\mathbf{S} = -200 \mathbf{i} \cdot \Delta\mathbf{S} \\
 &= +200 \Delta S, \text{ since } \mathbf{i} \cdot \Delta\mathbf{S} = -\Delta S \\
 &= +200 \times \pi (0.05)^2 = +1.57 \text{ N m}^2 \text{ C}^{-1}
 \end{aligned}$$

On the right face, \mathbf{E} and $\Delta\mathbf{S}$ are parallel and therefore

$$\phi_R = \mathbf{E} \cdot \Delta\mathbf{S} = +1.57 \text{ N m}^2 \text{ C}^{-1}.$$

(b) For any point on the side of the cylinder \mathbf{E} is perpendicular to $\Delta\mathbf{S}$ and hence $\mathbf{E} \cdot \Delta\mathbf{S} = 0$. Therefore, the flux out of the side of the cylinder is zero.

(c) Net outward flux through the cylinder

$$\phi = 1.57 + 1.57 + 0 = 3.14 \text{ N m}^2 \text{ C}^{-1}$$

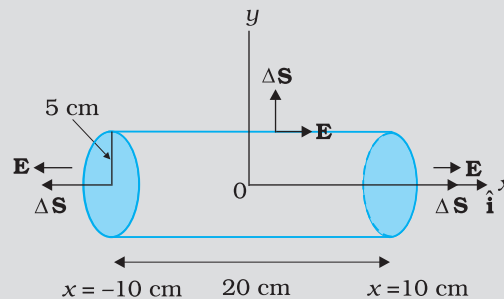

FIGURE 1.25

(d) The net charge within the cylinder can be found by using Gauss's law which gives

$$\begin{aligned}
 q &= \epsilon_0 \phi \\
 &= 3.14 \times 8.854 \times 10^{-12} \text{ C} \\
 &= 2.78 \times 10^{-11} \text{ C}
 \end{aligned}$$

1.14 APPLICATIONS OF GAUSS'S LAW

The electric field due to a general charge distribution is, as seen above, given by Eq. (1.27). In practice, except for some special cases, the summation (or integration) involved in this equation cannot be carried out to give electric field at every point in space. For some symmetric charge configurations, however, it is possible to obtain the electric field in a simple way using the Gauss's law. This is best understood by some examples.

1.14.1 Field due to an infinitely long straight uniformly charged wire

Consider an infinitely long thin straight wire with uniform linear charge density λ . The wire is obviously an axis of symmetry. Suppose we take the radial vector from O to P and rotate it around the wire. The points P , P' , P'' so obtained are completely equivalent with respect to the charged wire. This implies that the electric field must have the same magnitude at these points. The direction of electric field at every point must be radial (outward if $\lambda > 0$, inward if $\lambda < 0$). This is clear from Fig. 1.26.

Consider a pair of line elements P_1 and P_2 of the wire, as shown. The electric fields produced by the two elements of the pair when summed give a resultant electric field which is radial (the components normal to the radial vector cancel). This is true for any such pair and hence the total field at any point P is radial. Finally, since the wire is infinite, electric field does not depend on the position of P along the length of the wire. In short, the electric field is everywhere radial in the plane cutting the wire normally, and its magnitude depends only on the radial distance r .

To calculate the field, imagine a cylindrical Gaussian surface, as shown in the Fig. 1.26(b). Since the field is everywhere radial, flux through the two ends of the cylindrical Gaussian surface is zero. At the cylindrical part of the surface, \mathbf{E} is normal to the surface at every point, and its magnitude is constant, since it depends only on r . The surface area of the curved part is $2\pi rl$, where l is the length of the cylinder.

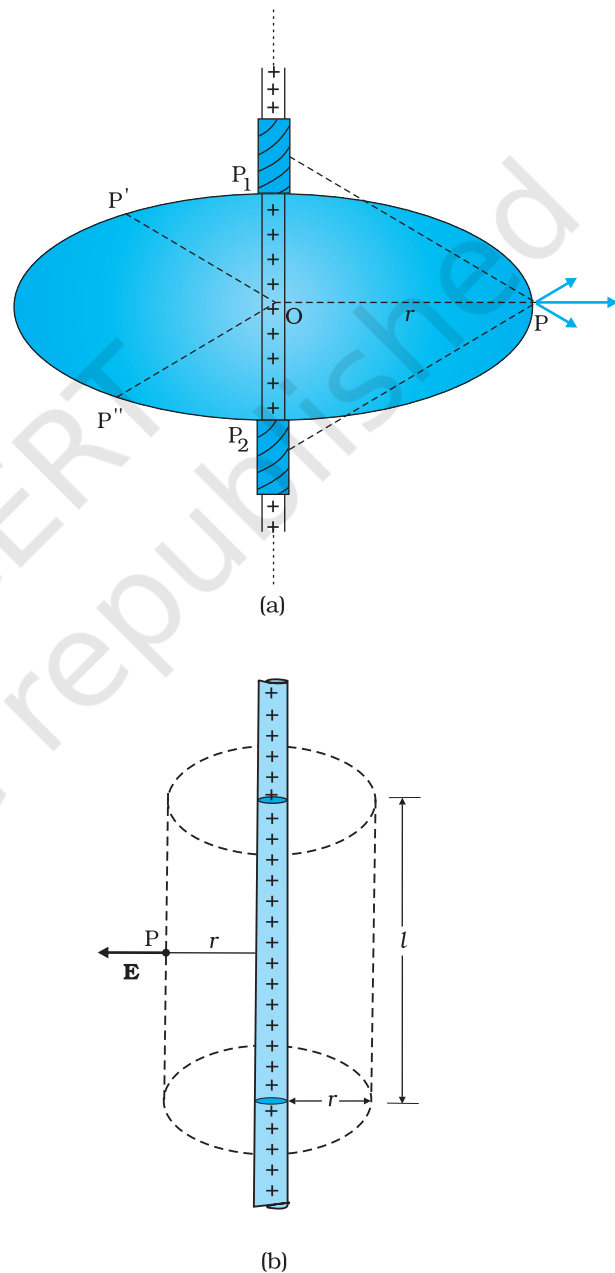

FIGURE 1.26 (a) Electric field due to an infinitely long thin straight wire is radial, (b) The Gaussian surface for a long thin wire of uniform linear charge density.

Flux through the Gaussian surface

$$= \text{flux through the curved cylindrical part of the surface}$$

$$= E \times 2\pi r l$$

The surface includes charge equal to λl . Gauss's law then gives

$$E \times 2\pi r l = \lambda l / \epsilon_0$$

$$\text{i.e., } E = \frac{\lambda}{2\pi\epsilon_0 r}$$

Vectorially, \mathbf{E} at any point is given by

$$\mathbf{E} = \frac{\lambda}{2\pi\epsilon_0 r} \hat{\mathbf{n}} \quad (1.32)$$

where $\hat{\mathbf{n}}$ is the radial unit vector in the plane normal to the wire passing through the point. \mathbf{E} is directed outward if λ is positive and inward if λ is negative.

Note that when we write a vector \mathbf{A} as a scalar multiplied by a unit vector, i.e., as $\mathbf{A} = A \hat{\mathbf{a}}$, the scalar A is an algebraic number. It can be negative or positive. The direction of \mathbf{A} will be the same as that of the unit vector $\hat{\mathbf{a}}$ if $A > 0$ and opposite to $\hat{\mathbf{a}}$ if $A < 0$. When we want to restrict to non-negative values, we use the symbol $|\mathbf{A}|$ and call it the modulus of \mathbf{A} . Thus, $|\mathbf{A}| \geq 0$.

Also note that though only the charge enclosed by the surface (λl) was included above, the electric field \mathbf{E} is due to the charge on the entire wire. Further, the assumption that the wire is infinitely long is crucial. Without this assumption, we cannot take \mathbf{E} to be normal to the curved part of the cylindrical Gaussian surface. However, Eq. (1.32) is approximately true for electric field around the central portions of a long wire, where the end effects may be ignored.

1.14.2 Field due to a uniformly charged infinite plane sheet

Let σ be the uniform surface charge density of an infinite plane sheet (Fig. 1.27). We take the x -axis normal to the given plane. By symmetry, the electric field will not depend on y and z coordinates and its direction at every point must be parallel to the x -direction.

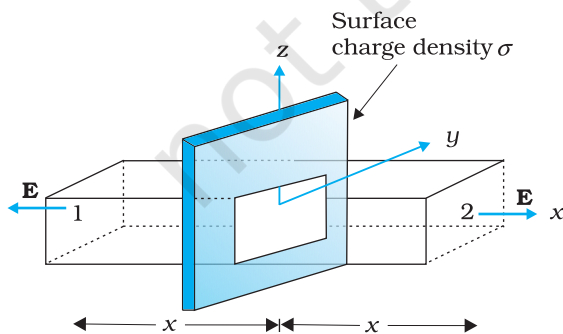

FIGURE 1.27 Gaussian surface for a uniformly charged infinite plane sheet.

We can take the Gaussian surface to be a rectangular parallelepiped of cross-sectional area A , as shown. (A cylindrical surface will also do.) As seen from the figure, only the two faces 1 and 2 will contribute to the flux; electric field lines are parallel to the other faces and they, therefore, do not contribute to the total flux.

The unit vector normal to surface 1 is in $-x$ direction while the unit vector normal to surface 2 is in the $+x$ direction. Therefore, flux $\mathbf{E} \cdot \Delta\mathbf{S}$ through both the surfaces are equal and add up. Therefore the net flux through the Gaussian surface is $2EA$. The charge enclosed by the closed surface is σA . Therefore by Gauss's law,

$$2 EA = \sigma A / \epsilon_0$$

$$\text{or, } E = \sigma / 2\epsilon_0$$

Vectorically,

$$\mathbf{E} = \frac{\sigma}{2\epsilon_0} \hat{\mathbf{n}} \quad (1.33)$$

where $\hat{\mathbf{n}}$ is a unit vector normal to the plane and going away from it.

\mathbf{E} is directed away from the plate if σ is positive and toward the plate if σ is negative. Note that the above application of the Gauss' law has brought out an additional fact: E is independent of x also.

For a finite large planar sheet, Eq. (1.33) is approximately true in the middle regions of the planar sheet, away from the ends.

1.14.3 Field due to a uniformly charged thin spherical shell

Let σ be the uniform surface charge density of a thin spherical shell of radius R (Fig. 1.28). The situation has obvious spherical symmetry. The field at any point P, outside or inside, can depend only on r (the radial distance from the centre of the shell to the point) and must be radial (i.e., along the radius vector).

(i) Field outside the shell: Consider a point P outside the shell with radius vector \mathbf{r} . To calculate \mathbf{E} at P, we take the Gaussian surface to be a sphere of radius r and with centre O, passing through P. All points on this sphere are equivalent relative to the given charged configuration. (That is what we mean by spherical symmetry.) The electric field at each point of the Gaussian surface, therefore, has the same magnitude E and is along the radius vector at each point. Thus, \mathbf{E} and $\Delta\mathbf{S}$ at every point are parallel and the flux through each element is $E \Delta S$. Summing over all ΔS , the flux through the Gaussian surface is $E \times 4 \pi r^2$. The charge enclosed is $\sigma \times 4 \pi R^2$. By Gauss's law

$$E \times 4 \pi r^2 = \frac{\sigma}{\epsilon_0} 4 \pi R^2$$

$$\text{Or, } E = \frac{\sigma R^2}{\epsilon_0 r^2} = \frac{q}{4 \pi \epsilon_0 r^2}$$

where $q = 4 \pi R^2 \sigma$ is the total charge on the spherical shell. Vectorially,

$$\mathbf{E} = \frac{q}{4 \pi \epsilon_0 r^2} \hat{\mathbf{r}} \quad (1.34)$$

The electric field is directed outward if $q > 0$ and inward if $q < 0$. This, however, is exactly the field produced by a charge q placed at the centre O. Thus for points outside the shell, the field due to a uniformly charged shell is as if the entire charge of the shell is concentrated at its centre.

(ii) Field inside the shell: In Fig. 1.28(b), the point P is inside the shell. The Gaussian surface is again a sphere through P centred at O.

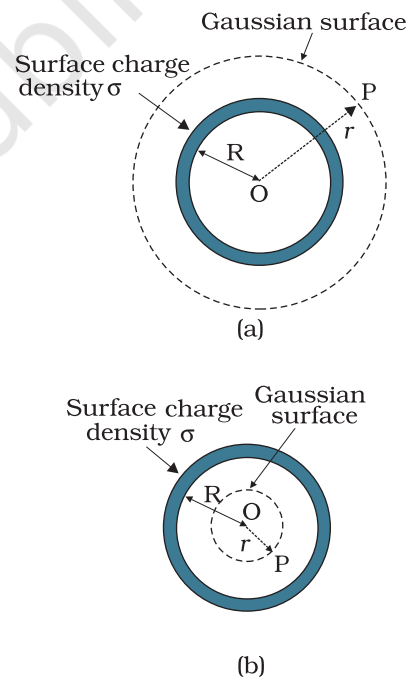

FIGURE 1.28 Gaussian surfaces for a point with (a) $r > R$, (b) $r < R$.

The flux through the Gaussian surface, calculated as before, is $E \times 4 \pi r^2$. However, in this case, the Gaussian surface encloses no charge. Gauss's law then gives

$$E \times 4 \pi r^2 = 0$$

$$\text{i.e., } E = 0 \quad (r < R) \quad (1.35)$$

that is, the field due to a uniformly charged thin shell is zero at all points inside the shell*. This important result is a direct consequence of Gauss's law which follows from Coulomb's law. The experimental verification of this result confirms the $1/r^2$ dependence in Coulomb's law.

Example 1.12 An early model for an atom considered it to have a positively charged point nucleus of charge Ze , surrounded by a uniform density of negative charge up to a radius R . The atom as a whole is neutral. For this model, what is the electric field at a distance r from the nucleus?

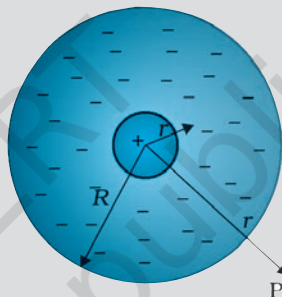

FIGURE 1.29

Solution The charge distribution for this model of the atom is as shown in Fig. 1.29. The total negative charge in the uniform spherical charge distribution of radius R must be $-Ze$, since the atom (nucleus of charge Ze + negative charge) is neutral. This immediately gives us the negative charge density ρ , since we must have

$$\frac{4\pi R^3}{3} \rho = 0 - Ze$$

$$\text{or } \rho = -\frac{3Ze}{4\pi R^3}$$

To find the electric field $\mathbf{E}(\mathbf{r})$ at a point P which is a distance r away from the nucleus, we use Gauss's law. Because of the spherical symmetry of the charge distribution, the magnitude of the electric field $\mathbf{E}(\mathbf{r})$ depends only on the radial distance, no matter what the direction of \mathbf{r} . Its direction is along (or opposite to) the radius vector \mathbf{r} from the origin to the point P. The obvious Gaussian surface is a spherical surface centred at the nucleus. We consider two situations, namely, $r < R$ and $r > R$.

(i) $r < R$: The electric flux ϕ enclosed by the spherical surface is

$$\phi = E(r) \times 4 \pi r^2$$

EXAMPLE 1.12

* Compare this with a uniform mass shell discussed in Section 7.5 of Class XI Textbook of Physics.

where $E(r)$ is the magnitude of the electric field at r . This is because the field at any point on the spherical Gaussian surface has the same direction as the normal to the surface there, and has the same magnitude at all points on the surface.

The charge q enclosed by the Gaussian surface is the positive nuclear charge and the negative charge within the sphere of radius r ,

$$\text{i.e., } q = Ze - \frac{4\pi r^3}{3}\rho$$

Substituting for the charge density ρ obtained earlier, we have

$$q = Ze - Ze \frac{r^3}{R^3}$$

Gauss's law then gives,

$$E(r) = \frac{Ze}{4\pi\epsilon_0} \left(\frac{1}{r^2} - \frac{r}{R^3} \right); \quad r < R$$

The electric field is directed radially outward.

(ii) $r > R$: In this case, the total charge enclosed by the Gaussian spherical surface is zero since the atom is neutral. Thus, from Gauss's law,

$$E(r) \times 4\pi r^2 = 0 \quad \text{or} \quad E(r) = 0; \quad r > R$$

At $r = R$, both cases give the same result: $E = 0$.

EXAMPLE 1.12

SUMMARY

1. Electric and magnetic forces determine the properties of atoms, molecules and bulk matter.
2. From simple experiments on frictional electricity, one can infer that there are two types of charges in nature; and that like charges repel and unlike charges attract. By convention, the charge on a glass rod rubbed with silk is positive; that on a plastic rod rubbed with fur is then negative.
3. Conductors allow movement of electric charge through them, insulators do not. In metals, the mobile charges are electrons; in electrolytes both positive and negative ions are mobile.
4. Electric charge has three basic properties: quantisation, additivity and conservation.

Quantisation of electric charge means that total charge (q) of a body is always an integral multiple of a basic quantum of charge (e) i.e., $q = ne$, where $n = 0, \pm 1, \pm 2, \pm 3, \dots$. Proton and electron have charges $+e, -e$, respectively. For macroscopic charges for which n is a very large number, quantisation of charge can be ignored.

Additivity of electric charges means that the total charge of a system is the algebraic sum (i.e., the sum taking into account proper signs) of all individual charges in the system.

Conservation of electric charges means that the total charge of an isolated system remains unchanged with time. This means that when

bodies are charged through friction, there is a transfer of electric charge from one body to another, but no creation or destruction of charge.

5. *Coulomb's Law*: The mutual electrostatic force between two point charges q_1 and q_2 is proportional to the product q_1q_2 and inversely proportional to the square of the distance r_{21} separating them. Mathematically,

$$\mathbf{F}_{21} = \text{force on } q_2 \text{ due to } q_1 = \frac{k (q_1q_2)}{r_{21}^2} \hat{\mathbf{r}}_{21}$$

where $\hat{\mathbf{r}}_{21}$ is a unit vector in the direction from q_1 to q_2 and $k = \frac{1}{4\pi\epsilon_0}$ is the constant of proportionality.

In SI units, the unit of charge is coulomb. The experimental value of the constant ϵ_0 is

$$\epsilon_0 = 8.854 \times 10^{-12} \text{ C}^2 \text{ N}^{-1} \text{ m}^{-2}$$

The approximate value of k is

$$k = 9 \times 10^9 \text{ N m}^2 \text{ C}^{-2}$$

6. The ratio of electric force and gravitational force between a proton and an electron is

$$\frac{k e^2}{G m_e m_p} \cong 2.4 \times 10^{39}$$

7. *Superposition Principle*: The principle is based on the property that the forces with which two charges attract or repel each other are not affected by the presence of a third (or more) additional charge(s). For an assembly of charges q_1, q_2, q_3, \dots , the force on any charge, say q_1 , is the vector sum of the force on q_1 due to q_2 , the force on q_1 due to q_3 , and so on. For each pair, the force is given by the Coulomb's law for two charges stated earlier.
8. The electric field \mathbf{E} at a point due to a charge configuration is the force on a small positive test charge q placed at the point divided by the magnitude of the charge. Electric field due to a point charge q has a magnitude $|q|/4\pi\epsilon_0 r^2$; it is radially outwards from q , if q is positive, and radially inwards if q is negative. Like Coulomb force, electric field also satisfies superposition principle.
9. An electric field line is a curve drawn in such a way that the tangent at each point on the curve gives the direction of electric field at that point. The relative closeness of field lines indicates the relative strength of electric field at different points; they crowd near each other in regions of strong electric field and are far apart where the electric field is weak. In regions of constant electric field, the field lines are uniformly spaced parallel straight lines.
10. Some of the important properties of field lines are: (i) Field lines are continuous curves without any breaks. (ii) Two field lines cannot cross each other. (iii) Electrostatic field lines start at positive charges and end at negative charges—they cannot form closed loops.
11. An electric dipole is a pair of equal and opposite charges q and $-q$ separated by some distance $2a$. Its dipole moment vector \mathbf{p} has magnitude $2qa$ and is in the direction of the dipole axis from $-q$ to q .

12. Field of an electric dipole in its equatorial plane (i.e., the plane perpendicular to its axis and passing through its centre) at a distance r from the centre:

$$\mathbf{E} = \frac{-\mathbf{p}}{4\pi\epsilon_0} \frac{1}{(a^2 + r^2)^{3/2}}$$

$$\cong \frac{-\mathbf{p}}{4\pi\epsilon_0 r^3}, \quad \text{for } r \gg a$$

Dipole electric field on the axis at a distance r from the centre:

$$\mathbf{E} = \frac{2\mathbf{p}r}{4\pi\epsilon_0(r^2 - a^2)^2}$$

$$\cong \frac{2\mathbf{p}}{4\pi\epsilon_0 r^3} \quad \text{for } r \gg a$$

The $1/r^3$ dependence of dipole electric fields should be noted in contrast to the $1/r^2$ dependence of electric field due to a point charge.

13. In a uniform electric field \mathbf{E} , a dipole experiences a torque $\boldsymbol{\tau}$ given by

$$\boldsymbol{\tau} = \mathbf{p} \times \mathbf{E}$$

but experiences no net force.

14. The flux $\Delta\phi$ of electric field \mathbf{E} through a small area element $\Delta\mathbf{S}$ is given by

$$\Delta\phi = \mathbf{E} \cdot \Delta\mathbf{S}$$

The vector area element $\Delta\mathbf{S}$ is

$$\Delta\mathbf{S} = \Delta S \hat{\mathbf{n}}$$

where ΔS is the magnitude of the area element and $\hat{\mathbf{n}}$ is normal to the area element, which can be considered planar for sufficiently small ΔS .

For an area element of a closed surface, $\hat{\mathbf{n}}$ is taken to be the direction of *outward* normal, by convention.

15. *Gauss's law*: The flux of electric field through any closed surface S is $1/\epsilon_0$ times the total charge enclosed by S . The law is especially useful in determining electric field \mathbf{E} , when the source distribution has simple symmetry:

(i) *Thin infinitely long straight wire of uniform linear charge density λ*

$$\mathbf{E} = \frac{\lambda}{2\pi\epsilon_0 r} \hat{\mathbf{n}}$$

where r is the perpendicular distance of the point from the wire and $\hat{\mathbf{n}}$ is the radial unit vector in the plane normal to the wire passing through the point.

(ii) *Infinite thin plane sheet of uniform surface charge density σ*

$$\mathbf{E} = \frac{\sigma}{2\epsilon_0} \hat{\mathbf{n}}$$

where $\hat{\mathbf{n}}$ is a unit vector normal to the plane, outward on either side.

(iii) Thin spherical shell of uniform surface charge density σ

$$\mathbf{E} = \frac{q}{4 \pi \epsilon_0 r^2} \hat{\mathbf{r}} \quad (r \geq R)$$

$$\mathbf{E} = 0 \quad (r < R)$$

where r is the distance of the point from the centre of the shell and R the radius of the shell. q is the total charge of the shell: $q = 4\pi R^2\sigma$.

The electric field outside the shell is as though the total charge is concentrated at the centre. The same result is true for a solid sphere of uniform volume charge density. The field is zero at all points inside the shell.

Physical quantity	Symbol	Dimensions	Unit	Remarks
Vector area element	$\Delta \mathbf{S}$	$[L^2]$	m^2	$\Delta \mathbf{S} = \Delta S \hat{\mathbf{n}}$
Electric field	\mathbf{E}	$[MLT^{-3}A^{-1}]$	$V m^{-1}$	
Electric flux	ϕ	$[ML^3 T^{-3}A^{-1}]$	$V m$	$\Delta \phi = \mathbf{E} \cdot \Delta \mathbf{S}$
Dipole moment	\mathbf{p}	$[LTA]$	$C m$	Vector directed from negative to positive charge
Charge density:				
linear	λ	$[L^{-1} TA]$	$C m^{-1}$	Charge/length
surface	σ	$[L^{-2} TA]$	$C m^{-2}$	Charge/area
volume	ρ	$[L^{-3} TA]$	$C m^{-3}$	Charge/volume

POINTS TO PONDER

1. You might wonder why the protons, all carrying positive charges, are compactly residing inside the nucleus. Why do they not fly away? You will learn that there is a third kind of a fundamental force, called the strong force which holds them together. The range of distance where this force is effective is, however, very small $\sim 10^{-14}$ m. This is precisely the size of the nucleus. Also the electrons are not allowed to sit on top of the protons, i.e. inside the nucleus, due to the laws of quantum mechanics. This gives the atoms their structure as they exist in nature.
2. Coulomb force and gravitational force follow the same inverse-square law. But gravitational force has only one sign (always attractive), while

Coulomb force can be of both signs (attractive and repulsive), allowing possibility of cancellation of electric forces. This is how gravity, despite being a much weaker force, can be a dominating and more pervasive force in nature.

- The constant of proportionality k in Coulomb's law is a matter of choice if the unit of charge is to be defined using Coulomb's law. In SI units, however, what is defined is the unit of current (A) via its magnetic effect (Ampere's law) and the unit of charge (coulomb) is simply defined by ($1\text{C} = 1\text{A s}$). In this case, the value of k is no longer arbitrary; it is approximately $9 \times 10^9\text{ N m}^2\text{ C}^{-2}$.
- The rather large value of k , i.e., the large size of the unit of charge (1C) from the point of view of electric effects arises because (as mentioned in point 3 already) the unit of charge is defined in terms of magnetic forces (forces on current-carrying wires) which are generally much weaker than the electric forces. Thus while 1 ampere is a unit of reasonable size for magnetic effects, $1\text{C} = 1\text{A s}$, is too big a unit for electric effects.
- The additive property of charge is not an 'obvious' property. It is related to the fact that electric charge has no direction associated with it; charge is a scalar.
- Charge is not only a scalar (or invariant) under rotation; it is also invariant for frames of reference in relative motion. This is not always true for every scalar. For example, kinetic energy is a scalar under rotation, but is not invariant for frames of reference in relative motion.
- Conservation of total charge of an isolated system is a property independent of the scalar nature of charge noted in point 6. Conservation refers to invariance in time in a given frame of reference. A quantity may be scalar but not conserved (like kinetic energy in an inelastic collision). On the other hand, one can have conserved vector quantity (e.g., angular momentum of an isolated system).
- Quantisation of electric charge is a basic (unexplained) law of nature; interestingly, there is no analogous law on quantisation of mass.
- Superposition principle should not be regarded as 'obvious', or equated with the law of addition of vectors. It says two things: force on one charge due to another charge is unaffected by the presence of other charges, and there are no additional three-body, four-body, etc., forces which arise only when there are more than two charges.
- The electric field due to a discrete charge configuration is not defined at the locations of the discrete charges. For continuous volume charge distribution, it is defined at any point in the distribution. For a surface charge distribution, electric field is discontinuous across the surface.
- The electric field due to a charge configuration with total charge zero is not zero; but for distances large compared to the size of the configuration, its field falls off faster than $1/r^2$, typical of field due to a single charge. An electric dipole is the simplest example of this fact.

EXERCISES

- 1.1** What is the force between two small charged spheres having charges of $2 \times 10^{-7}\text{C}$ and $3 \times 10^{-7}\text{C}$ placed 30 cm apart in air?
- 1.2** The electrostatic force on a small sphere of charge $0.4 \mu\text{C}$ due to another small sphere of charge $-0.8 \mu\text{C}$ in air is 0.2 N. (a) What is the distance between the two spheres? (b) What is the force on the second sphere due to the first?
- 1.3** Check that the ratio $ke^2/G m_e m_p$ is dimensionless. Look up a Table of Physical Constants and determine the value of this ratio. What does the ratio signify?
- 1.4** (a) Explain the meaning of the statement 'electric charge of a body is quantised'.
(b) Why can one ignore quantisation of electric charge when dealing with macroscopic i.e., large scale charges?
- 1.5** When a glass rod is rubbed with a silk cloth, charges appear on both. A similar phenomenon is observed with many other pairs of bodies. Explain how this observation is consistent with the law of conservation of charge.
- 1.6** Four point charges $q_A = 2 \mu\text{C}$, $q_B = -5 \mu\text{C}$, $q_C = 2 \mu\text{C}$, and $q_D = -5 \mu\text{C}$ are located at the corners of a square ABCD of side 10 cm. What is the force on a charge of $1 \mu\text{C}$ placed at the centre of the square?
- 1.7** (a) An electrostatic field line is a continuous curve. That is, a field line cannot have sudden breaks. Why not?
(b) Explain why two field lines never cross each other at any point?
- 1.8** Two point charges $q_A = 3 \mu\text{C}$ and $q_B = -3 \mu\text{C}$ are located 20 cm apart in vacuum.
(a) What is the electric field at the midpoint O of the line AB joining the two charges?
(b) If a negative test charge of magnitude $1.5 \times 10^{-9} \text{C}$ is placed at this point, what is the force experienced by the test charge?
- 1.9** A system has two charges $q_A = 2.5 \times 10^{-7} \text{C}$ and $q_B = -2.5 \times 10^{-7} \text{C}$ located at points A: (0, 0, -15 cm) and B: (0, 0, +15 cm), respectively. What are the total charge and electric dipole moment of the system?
- 1.10** An electric dipole with dipole moment $4 \times 10^{-9} \text{C m}$ is aligned at 30° with the direction of a uniform electric field of magnitude $5 \times 10^4 \text{NC}^{-1}$. Calculate the magnitude of the torque acting on the dipole.
- 1.11** A polythene piece rubbed with wool is found to have a negative charge of $3 \times 10^{-7} \text{C}$.
(a) Estimate the number of electrons transferred (from which to which?)
(b) Is there a transfer of mass from wool to polythene?
- 1.12** (a) Two insulated charged copper spheres A and B have their centres separated by a distance of 50 cm. What is the mutual force of electrostatic repulsion if the charge on each is $6.5 \times 10^{-7} \text{C}$? The radii of A and B are negligible compared to the distance of separation.
(b) What is the force of repulsion if each sphere is charged double the above amount, and the distance between them is halved?
- 1.13** Figure 1.30 shows tracks of three charged particles in a uniform electrostatic field. Give the signs of the three charges. Which particle has the highest charge to mass ratio?

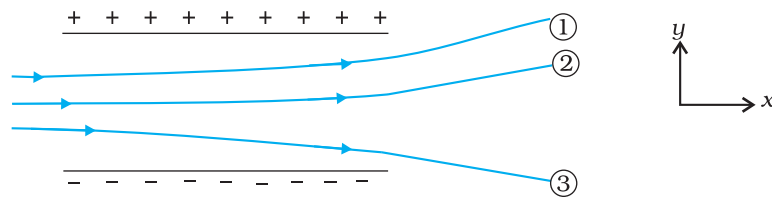

FIGURE 1.30

- 1.14** Consider a uniform electric field $\mathbf{E} = 3 \times 10^3 \hat{i}$ N/C. (a) What is the flux of this field through a square of 10 cm on a side whose plane is parallel to the yz plane? (b) What is the flux through the same square if the normal to its plane makes a 60° angle with the x -axis?
- 1.15** What is the net flux of the uniform electric field of Exercise 1.14 through a cube of side 20 cm oriented so that its faces are parallel to the coordinate planes?
- 1.16** Careful measurement of the electric field at the surface of a black box indicates that the net outward flux through the surface of the box is 8.0×10^3 Nm²/C. (a) What is the net charge inside the box? (b) If the net outward flux through the surface of the box were zero, could you conclude that there were no charges inside the box? Why or Why not?
- 1.17** A point charge $+10 \mu\text{C}$ is a distance 5 cm directly above the centre of a square of side 10 cm, as shown in Fig. 1.31. What is the magnitude of the electric flux through the square? (*Hint: Think of the square as one face of a cube with edge 10 cm.*)

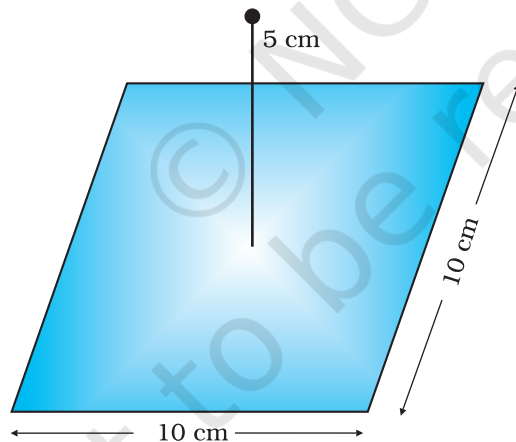
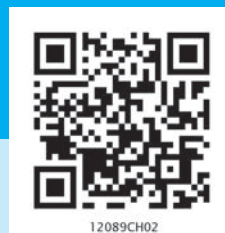

FIGURE 1.31

- 1.18** A point charge of $2.0 \mu\text{C}$ is at the centre of a cubic Gaussian surface 9.0 cm on edge. What is the net electric flux through the surface?
- 1.19** A point charge causes an electric flux of -1.0×10^3 Nm²/C to pass through a spherical Gaussian surface of 10.0 cm radius centred on the charge. (a) If the radius of the Gaussian surface were doubled, how much flux would pass through the surface? (b) What is the value of the point charge?
- 1.20** A conducting sphere of radius 10 cm has an unknown charge. If the electric field 20 cm from the centre of the sphere is 1.5×10^3 N/C and points radially inward, what is the net charge on the sphere?

- 1.21** A uniformly charged conducting sphere of 2.4 m diameter has a surface charge density of $80.0 \mu\text{C}/\text{m}^2$. (a) Find the charge on the sphere. (b) What is the total electric flux leaving the surface of the sphere?
- 1.22** An infinite line charge produces a field of $9 \times 10^4 \text{ N/C}$ at a distance of 2 cm. Calculate the linear charge density.
- 1.23** Two large, thin metal plates are parallel and close to each other. On their inner faces, the plates have surface charge densities of opposite signs and of magnitude $17.0 \times 10^{-22} \text{ C}/\text{m}^2$. What is **E**: (a) in the outer region of the first plate, (b) in the outer region of the second plate, and (c) between the plates?

© NCERT
not to be republished



Chapter Two

ELECTROSTATIC POTENTIAL AND CAPACITANCE

2.1 INTRODUCTION

In Chapters 5 and 7 (Class XI), the notion of potential energy was introduced. When an external force does work in taking a body from a point to another against a force like spring force or gravitational force, that work gets stored as potential energy of the body. When the external force is removed, the body moves, gaining kinetic energy and losing an equal amount of potential energy. The sum of kinetic and potential energies is thus conserved. Forces of this kind are called conservative forces. Spring force and gravitational force are examples of conservative forces.

Coulomb force between two (stationary) charges is also a conservative force. This is not surprising, since both have inverse-square dependence on distance and differ mainly in the proportionality constants – the masses in the gravitational law are replaced by charges in Coulomb's law. Thus, like the potential energy of a mass in a gravitational field, we can define electrostatic potential energy of a charge in an electrostatic field.

Consider an electrostatic field \mathbf{E} due to some charge configuration. First, for simplicity, consider the field \mathbf{E} due to a charge Q placed at the origin. Now, imagine that we bring a test charge q from a point R to a point P against the repulsive force on it due to the charge Q . With reference

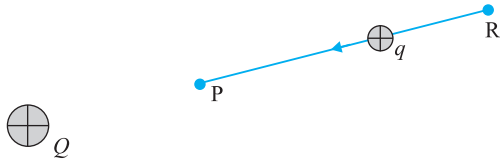

FIGURE 2.1 A test charge $q (> 0)$ is moved from the point R to the point P against the repulsive force on it by the charge $Q (> 0)$ placed at the origin.

to Fig. 2.1, this will happen if Q and q are both positive or both negative. For definiteness, let us take $Q, q > 0$.

Two remarks may be made here. First, we assume that the test charge q is so small that it does not disturb the original configuration, namely the charge Q at the origin (or else, we keep Q fixed at the origin by some unspecified force). Second, in bringing the charge q from R to P , we apply an external force \mathbf{F}_{ext} just enough to counter the repulsive electric force \mathbf{F}_E (i.e., $\mathbf{F}_{ext} = -\mathbf{F}_E$). This means there is no net force on or acceleration of the charge q when it is brought from R to P , i.e., it is brought with infinitesimally slow constant speed. In

this situation, work done by the external force is the negative of the work done by the electric force, and gets fully stored in the form of potential energy of the charge q . If the external force is removed on reaching P , the electric force will take the charge away from Q – the stored energy (potential energy) at P is used to provide kinetic energy to the charge q in such a way that the sum of the kinetic and potential energies is conserved.

Thus, work done by external forces in moving a charge q from R to P is

$$\begin{aligned}
 W_{RP} &= \int_R^P \mathbf{F}_{ext} \cdot d\mathbf{r} \\
 &= - \int_R^P \mathbf{F}_E \cdot d\mathbf{r} \quad (2.1)
 \end{aligned}$$

This work done is against electrostatic repulsive force and gets stored as potential energy.

At every point in electric field, a particle with charge q possesses a certain electrostatic potential energy, this work done increases its potential energy by an amount equal to potential energy difference between points R and P .

Thus, potential energy difference

$$\Delta U = U_P - U_R = W_{RP} \quad (2.2)$$

(Note here that this displacement is in an opposite sense to the electric force and hence work done by electric field is negative, i.e., $-W_{RP}$.)

Therefore, we can define electric potential energy difference between two points as the work required to be done by an external force in moving (without accelerating) charge q from one point to another for electric field of any arbitrary charge configuration.

Two important comments may be made at this stage:

- (i) The right side of Eq. (2.2) depends only on the initial and final positions of the charge. It means that the work done by an electrostatic field in moving a charge from one point to another depends only on the initial and the final points and is independent of the path taken to go from one point to the other. This is the fundamental characteristic of a conservative force. The concept of the potential energy would not be meaningful if the work depended on the path. The path-independence of work done by an electrostatic field can be proved using the Coulomb's law. We omit this proof here.

- (ii) Equation (2.2) defines *potential energy difference* in terms of the physically meaningful quantity *work*. Clearly, potential energy so defined is undetermined to within an additive constant. What this means is that the actual value of potential energy is not physically significant; it is only the difference of potential energy that is significant. We can always add an arbitrary constant α to potential energy at every point, since this will not change the potential energy difference:

$$(U_P + \alpha) - (U_R + \alpha) = U_P - U_R$$

Put it differently, there is a freedom in choosing the point where potential energy is zero. A convenient choice is to have electrostatic potential energy zero at infinity. With this choice, if we take the point R at infinity, we get from Eq. (2.2)

$$W_{\infty P} = U_P - U_{\infty} = U_P \quad (2.3)$$

Since the point P is arbitrary, Eq. (2.3) provides us with a definition of potential energy of a charge q at any point. *Potential energy of charge q at a point* (in the presence of field due to any charge configuration) *is the work done by the external force* (equal and opposite to the electric force) *in bringing the charge q from infinity to that point.*

2.2 ELECTROSTATIC POTENTIAL

Consider any general static charge configuration. We define potential energy of a test charge q in terms of the work done on the charge q . This work is obviously proportional to q , since the force at any point is $q\mathbf{E}$, where \mathbf{E} is the electric field at that point due to the given charge configuration. It is, therefore, convenient to divide the work by the amount of charge q , so that the resulting quantity is independent of q . In other words, work done per unit test charge is characteristic of the electric field associated with the charge configuration. This leads to the idea of electrostatic potential V due to a given charge configuration. From Eq. (2.1), we get:

Work done by external force in bringing a unit positive charge from point R to P

$$= V_P - V_R \quad \left(= \frac{U_P - U_R}{q} \right) \quad (2.4)$$

where V_P and V_R are the electrostatic potentials at P and R, respectively. Note, as before, that it is not the actual value of potential but the potential difference that is physically significant. If, as before, we choose the potential to be zero at infinity, Eq. (2.4) implies:

Work done by an external force in bringing a unit positive charge from infinity to a point = electrostatic potential (V) at that point.



Count Alessandro Volta (1745 - 1827) Italian physicist, professor at Pavia. Volta established that the *animal electricity* observed by Luigi Galvani, 1737-1798, in experiments with frog muscle tissue placed in contact with dissimilar metals, was not due to any exceptional property of animal tissues but was also generated whenever any wet body was sandwiched between dissimilar metals. This led him to develop the first *voltaic pile*, or battery, consisting of a large stack of moist disks of cardboard (electrolyte) sandwiched between disks of metal (electrodes).

COUNT ALESSANDRO VOLTA (1745 - 1827)

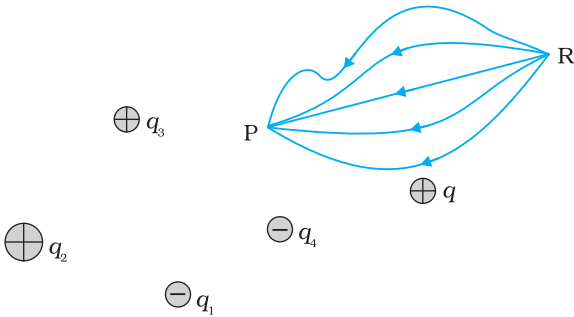

FIGURE 2.2 Work done on a test charge q by the electrostatic field due to any given charge configuration is independent of the path, and depends only on its initial and final positions.

In other words, the electrostatic potential (V) at any point in a region with electrostatic field is the work done in bringing a unit positive charge (without acceleration) from infinity to that point.

The qualifying remarks made earlier regarding potential energy also apply to the definition of potential. To obtain the work done per unit test charge, we should take an infinitesimal test charge δq , obtain the work done δW in bringing it from infinity to the point and determine the ratio $\delta W/\delta q$. Also, the external force at every point of the path is to be equal and opposite to the electrostatic force on the test charge at that point.

2.3 POTENTIAL DUE TO A POINT CHARGE

Consider a point charge Q at the origin (Fig. 2.3). For definiteness, take Q to be positive. We wish to determine the potential at any point P with position vector \mathbf{r} from the origin. For that we must calculate the work done in bringing a unit positive test charge from infinity to the point P . For $Q > 0$, the work done against the repulsive force on the test charge is positive. Since work done is independent of the path, we choose a convenient path – along the radial direction from infinity to the point P .

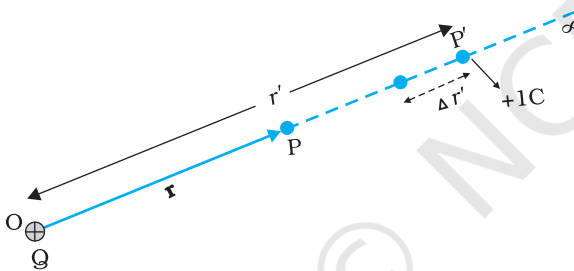

FIGURE 2.3 Work done in bringing a unit positive test charge from infinity to the point P , against the repulsive force of charge Q ($Q > 0$), is the potential at P due to the charge Q .

At some intermediate point P' on the path, the electrostatic force on a unit positive charge is

$$\frac{Q \times 1}{4\pi\epsilon_0 r'^2} \hat{\mathbf{r}}' \quad (2.5)$$

where $\hat{\mathbf{r}}'$ is the unit vector along OP' . Work done against this force from \mathbf{r}' to $\mathbf{r}' + \Delta\mathbf{r}'$ is

$$\Delta W = -\frac{Q}{4\pi\epsilon_0 r'^2} \Delta r' \quad (2.6)$$

The negative sign appears because for $\Delta r' < 0$, ΔW is positive. Total work done (W) by the external force is obtained by integrating Eq. (2.6) from $r' = \infty$ to $r' = r$,

$$W = -\int_{\infty}^r \frac{Q}{4\pi\epsilon_0 r'^2} dr' = \frac{Q}{4\pi\epsilon_0 r'} \Big|_{\infty}^r = \frac{Q}{4\pi\epsilon_0 r} \quad (2.7)$$

This, by definition is the potential at P due to the charge Q

$$V(r) = \frac{Q}{4\pi\epsilon_0 r} \quad (2.8)$$

Equation (2.8) is true for any sign of the charge Q , though we considered $Q > 0$ in its derivation. For $Q < 0$, $V < 0$, i.e., work done (by the external force) per unit positive test charge in bringing it from infinity to the point is negative. This is equivalent to saying that work done by the electrostatic force in bringing the unit positive charge from infinity to the point P is positive. [This is as it should be, since for $Q < 0$, the force on a unit positive test charge is attractive, so that the electrostatic force and the displacement (from infinity to P) are in the same direction.] Finally, we note that Eq. (2.8) is consistent with the choice that potential at infinity be zero.

Figure (2.4) shows how the electrostatic potential ($\propto 1/r$) and the electrostatic field ($\propto 1/r^2$) varies with r .

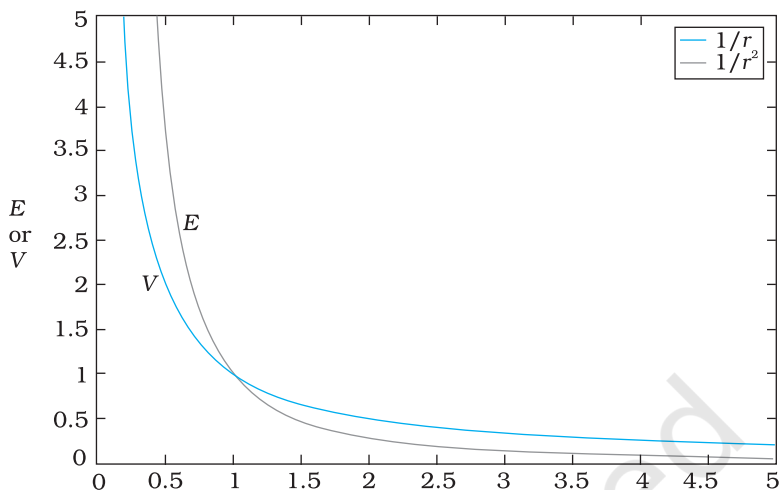

FIGURE 2.4 Variation of potential V with r [in units of $(Q/4\pi\epsilon_0) \text{ m}^{-1}$] (blue curve) and field with r [in units of $(Q/4\pi\epsilon_0) \text{ m}^{-2}$] (black curve) for a point charge Q .

Example 2.1

- Calculate the potential at a point P due to a charge of $4 \times 10^{-7} \text{ C}$ located 9 cm away.
- Hence obtain the work done in bringing a charge of $2 \times 10^{-9} \text{ C}$ from infinity to the point P. Does the answer depend on the path along which the charge is brought?

Solution

$$\begin{aligned} \text{(a) } V &= \frac{1}{4\pi\epsilon_0} \frac{Q}{r} = 9 \times 10^9 \text{ Nm}^2 \text{ C}^{-2} \times \frac{4 \times 10^{-7} \text{ C}}{0.09 \text{ m}} \\ &= 4 \times 10^4 \text{ V} \end{aligned}$$

$$\begin{aligned} \text{(b) } W &= qV = 2 \times 10^{-9} \text{ C} \times 4 \times 10^4 \text{ V} \\ &= 8 \times 10^{-5} \text{ J} \end{aligned}$$

No, work done will be path independent. Any arbitrary infinitesimal path can be resolved into two perpendicular displacements: One along \mathbf{r} and another perpendicular to \mathbf{r} . The work done corresponding to the later will be zero.

EXAMPLE 2.1

2.4 POTENTIAL DUE TO AN ELECTRIC DIPOLE

As we learnt in the last chapter, an electric dipole consists of two charges q and $-q$ separated by a (small) distance $2a$. Its total charge is zero. It is characterised by a dipole moment vector \mathbf{p} whose magnitude is $q \times 2a$ and which points in the direction from $-q$ to q (Fig. 2.5). We also saw that the electric field of a dipole at a point with position vector \mathbf{r} depends not just on the magnitude r , but also on the angle between \mathbf{r} and \mathbf{p} . Further,

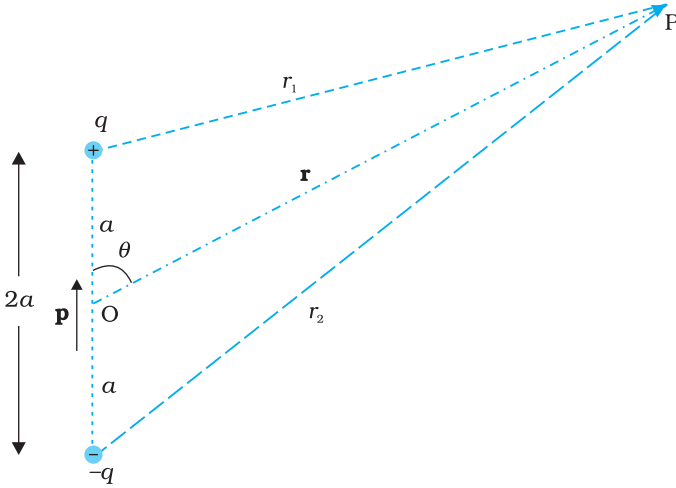

FIGURE 2.5 Quantities involved in the calculation of potential due to a dipole.

the field falls off, at large distance, not as $1/r^2$ (typical of field due to a single charge) but as $1/r^3$. We, now, determine the electric potential due to a dipole and contrast it with the potential due to a single charge.

As before, we take the origin at the centre of the dipole. Now we know that the electric field obeys the superposition principle. Since potential is related to the work done by the field, electrostatic potential also follows the superposition principle. Thus, the potential due to the dipole is the sum of potentials due to the charges q and $-q$

$$V = \frac{1}{4\pi\epsilon_0} \left(\frac{q}{r_1} - \frac{q}{r_2} \right) \quad (2.9)$$

where r_1 and r_2 are the distances of the point P from q and $-q$, respectively.

Now, by geometry,

$$\begin{aligned} r_1^2 &= r^2 + a^2 - 2ar \cos\theta \\ r_2^2 &= r^2 + a^2 + 2ar \cos\theta \end{aligned} \quad (2.10)$$

We take r much greater than a ($r \gg a$) and retain terms only upto the first order in a/r

$$\begin{aligned} r_1^2 &= r^2 \left(1 - \frac{2a \cos\theta}{r} + \frac{a^2}{r^2} \right) \\ &\cong r^2 \left(1 - \frac{2a \cos\theta}{r} \right) \end{aligned} \quad (2.11)$$

Similarly,

$$r_2^2 \cong r^2 \left(1 + \frac{2a \cos\theta}{r} \right) \quad (2.12)$$

Using the Binomial theorem and retaining terms upto the first order in a/r ; we obtain,

$$\frac{1}{r_1} \cong \frac{1}{r} \left(1 - \frac{2a \cos\theta}{r} \right)^{-1/2} \cong \frac{1}{r} \left(1 + \frac{a}{r} \cos\theta \right) \quad (2.13(a))$$

$$\frac{1}{r_2} \cong \frac{1}{r} \left(1 + \frac{2a \cos\theta}{r} \right)^{-1/2} \cong \frac{1}{r} \left(1 - \frac{a}{r} \cos\theta \right) \quad (2.13(b))$$

Using Eqs. (2.9) and (2.13) and $p = 2qa$, we get

$$V = \frac{q}{4\pi\epsilon_0} \frac{2a \cos\theta}{r^2} = \frac{p \cos\theta}{4\pi\epsilon_0 r^2} \quad (2.14)$$

Now, $p \cos\theta = \mathbf{p} \cdot \hat{\mathbf{r}}$

where $\hat{\mathbf{r}}$ is the unit vector along the position vector \mathbf{OP} .

The electric potential of a dipole is then given by

$$V = \frac{1}{4\pi\epsilon_0} \frac{\mathbf{p} \cdot \hat{\mathbf{r}}}{r^2}; \quad (r \gg a) \quad (2.15)$$

Equation (2.15) is, as indicated, approximately true only for distances large compared to the size of the dipole, so that higher order terms in a/r are negligible. For a point dipole \mathbf{p} at the origin, Eq. (2.15) is, however, exact.

From Eq. (2.15), potential on the dipole axis ($\theta = 0, \pi$) is given by

$$V = \pm \frac{1}{4\pi\epsilon_0} \frac{p}{r^2} \quad (2.16)$$

(Positive sign for $\theta = 0$, negative sign for $\theta = \pi$.) The potential in the equatorial plane ($\theta = \pi/2$) is zero.

The important contrasting features of electric potential of a dipole from that due to a single charge are clear from Eqs. (2.8) and (2.15):

- (i) The potential due to a dipole depends not just on r but also on the angle between the position vector \mathbf{r} and the dipole moment vector \mathbf{p} . (It is, however, axially symmetric about \mathbf{p} . That is, if you rotate the position vector \mathbf{r} about \mathbf{p} , keeping θ fixed, the points corresponding to P on the cone so generated will have the same potential as at P.)
- (ii) The electric dipole potential falls off, at large distance, as $1/r^2$, not as $1/r$, characteristic of the potential due to a single charge. (You can refer to the Fig. 2.5 for graphs of $1/r^2$ versus r and $1/r$ versus r , drawn there in another context.)

2.5 POTENTIAL DUE TO A SYSTEM OF CHARGES

Consider a system of charges q_1, q_2, \dots, q_n with position vectors $\mathbf{r}_1, \mathbf{r}_2, \dots, \mathbf{r}_n$ relative to some origin (Fig. 2.6). The potential V_1 at P due to the charge q_1 is

$$V_1 = \frac{1}{4\pi\epsilon_0} \frac{q_1}{r_{1P}}$$

where r_{1P} is the distance between q_1 and P.

Similarly, the potential V_2 at P due to q_2 and V_3 due to q_3 are given by

$$V_2 = \frac{1}{4\pi\epsilon_0} \frac{q_2}{r_{2P}}, \quad V_3 = \frac{1}{4\pi\epsilon_0} \frac{q_3}{r_{3P}}$$

where r_{2P} and r_{3P} are the distances of P from charges q_2 and q_3 , respectively; and so on for the potential due to other charges. By the superposition principle, the potential V at P due to the total charge configuration is the algebraic sum of the potentials due to the individual charges

$$V = V_1 + V_2 + \dots + V_n \quad (2.17)$$

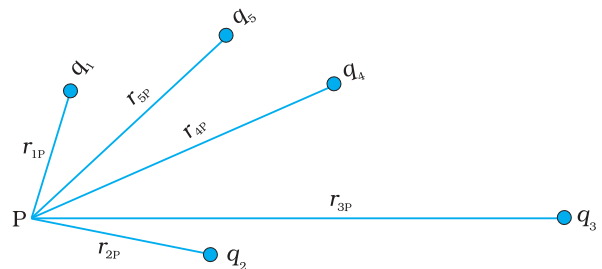

FIGURE 2.6 Potential at a point due to a system of charges is the sum of potentials due to individual charges.

$$= \frac{1}{4\pi\epsilon_0} \left(\frac{q_1}{r_{1P}} + \frac{q_2}{r_{2P}} + \dots + \frac{q_n}{r_{nP}} \right) \quad (2.18)$$

If we have a continuous charge distribution characterised by a charge density $\rho(\mathbf{r})$, we divide it, as before, into small volume elements each of size ΔV and carrying a charge $\rho\Delta V$. We then determine the potential due to each volume element and sum (strictly speaking, integrate) over all such contributions, and thus determine the potential due to the entire distribution.

We have seen in Chapter 1 that for a uniformly charged spherical shell, the electric field outside the shell is as if the entire charge is concentrated at the centre. Thus, the potential outside the shell is given by

$$V = \frac{1}{4\pi\epsilon_0} \frac{q}{r} \quad (r \geq R) \quad (2.19(a))$$

where q is the total charge on the shell and R its radius. The electric field inside the shell is zero. This implies (Section 2.6) that potential is constant inside the shell (as no work is done in moving a charge inside the shell), and, therefore, equals its value at the surface, which is

$$V = \frac{1}{4\pi\epsilon_0} \frac{q}{R} \quad (2.19(b))$$

Example 2.2 Two charges 3×10^{-8} C and -2×10^{-8} C are located 15 cm apart. At what point on the line joining the two charges is the electric potential zero? Take the potential at infinity to be zero.

Solution Let us take the origin O at the location of the positive charge. The line joining the two charges is taken to be the x -axis; the negative charge is taken to be on the right side of the origin (Fig. 2.7).

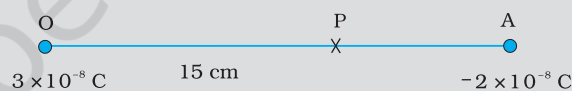

FIGURE 2.7

Let P be the required point on the x -axis where the potential is zero. If x is the x -coordinate of P, obviously x must be positive. (There is no possibility of potentials due to the two charges adding up to zero for $x < 0$.) If x lies between O and A, we have

$$\frac{1}{4\pi\epsilon_0} \left[\frac{3 \times 10^{-8}}{x \times 10^{-2}} - \frac{2 \times 10^{-8}}{(15 - x) \times 10^{-2}} \right] = 0$$

where x is in cm. That is,

$$\frac{3}{x} - \frac{2}{15 - x} = 0$$

which gives $x = 9$ cm.

If x lies on the extended line OA, the required condition is

$$\frac{3}{x} - \frac{2}{x - 15} = 0$$

which gives

$$x = 45 \text{ cm}$$

Thus, electric potential is zero at 9 cm and 45 cm away from the positive charge on the side of the negative charge. Note that the formula for potential used in the calculation required choosing potential to be zero at infinity.

EXAMPLE 2.2

Example 2.3 Figures 2.8 (a) and (b) show the field lines of a positive and negative point charge respectively.

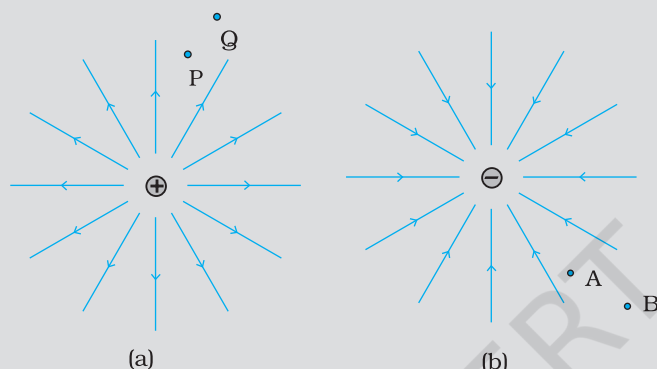

FIGURE 2.8

- (a) Give the signs of the potential difference $V_P - V_Q$; $V_B - V_A$.
- (b) Give the sign of the potential energy difference of a small negative charge between the points Q and P; A and B.
- (c) Give the sign of the work done by the field in moving a small positive charge from Q to P.
- (d) Give the sign of the work done by the external agency in moving a small negative charge from B to A.
- (e) Does the kinetic energy of a small negative charge increase or decrease in going from B to A?

Solution

- (a) As $V \propto \frac{1}{r}$, $V_P > V_Q$. Thus, $(V_P - V_Q)$ is positive. Also V_B is less negative than V_A . Thus, $V_B > V_A$ or $(V_B - V_A)$ is positive.
- (b) A small negative charge will be attracted towards positive charge. The negative charge moves from higher potential energy to lower potential energy. Therefore the sign of potential energy difference of a small negative charge between Q and P is positive. Similarly, $(P.E.)_A > (P.E.)_B$ and hence sign of potential energy differences is positive.
- (c) In moving a small positive charge from Q to P, work has to be done by an external agency against the electric field. Therefore, work done by the field is negative.
- (d) In moving a small negative charge from B to A work has to be done by the external agency. It is positive.
- (e) Due to force of repulsion on the negative charge, velocity decreases and hence the kinetic energy decreases in going from B to A.

PHYSICS

Electric potential, equipotential surfaces:
<http://video.mit.edu/watch/4-electrostatic-potential-elastic-energy-ev-conservative-field-equipotential-surfaces-12584/>

EXAMPLE 2.3

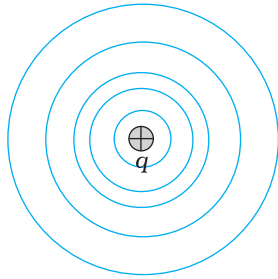

(a)

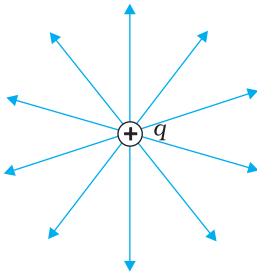

(b)

FIGURE 2.9 For a single charge q (a) equipotential surfaces are spherical surfaces centred at the charge, and (b) electric field lines are radial, starting from the charge if $q > 0$.

2.6 EQUIPOTENTIAL SURFACES

An equipotential surface is a surface with a constant value of potential at all points on the surface. For a single charge q , the potential is given by Eq. (2.8):

$$V = \frac{1}{4\pi\epsilon_0} \frac{q}{r}$$

This shows that V is a constant if r is constant. Thus, equipotential surfaces of a single point charge are concentric spherical surfaces centred at the charge.

Now the electric field lines for a single charge q are radial lines starting from or ending at the charge, depending on whether q is positive or negative. Clearly, the electric field at every point is normal to the equipotential surface passing through that point. This is true in general: *for any charge configuration, equipotential surface through a point is normal to the electric field at that point.* The proof of this statement is simple.

If the field were not normal to the equipotential surface, it would have non-zero component along the surface. To move a unit test charge against the direction of the component of the field, work would have to be done. But this is in contradiction to the definition of an equipotential surface: there is no potential difference between any two points on the surface and no work is required to move a test charge on the surface. The electric field must, therefore, be normal to the equipotential surface at every point. Equipotential surfaces offer an alternative visual picture in addition to the picture of electric field lines around a charge configuration.

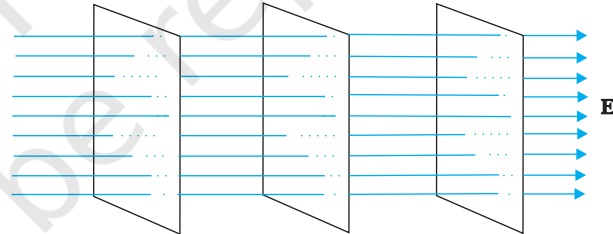
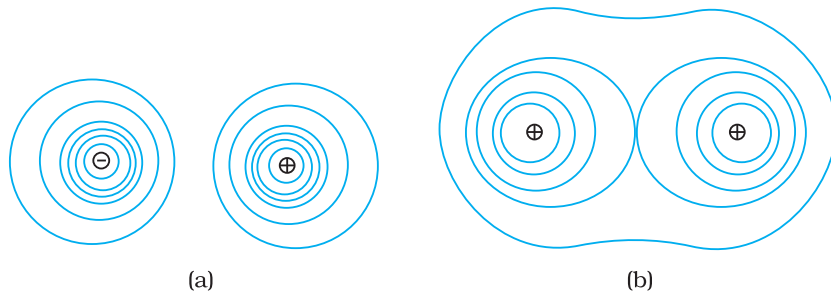

FIGURE 2.10 Equipotential surfaces for a uniform electric field.

For a uniform electric field \mathbf{E} , say, along the x -axis, the equipotential surfaces are planes normal to the x -axis, i.e., planes parallel to the y - z plane (Fig. 2.10). Equipotential surfaces for (a) a dipole and (b) two identical positive charges are shown in Fig. 2.11.



(a)

(b)

FIGURE 2.11 Some equipotential surfaces for (a) a dipole, (b) two identical positive charges.

2.6.1 Relation between field and potential

Consider two closely spaced equipotential surfaces A and B (Fig. 2.12) with potential values V and $V + \delta V$, where δV is the change in V in the direction of the electric field \mathbf{E} . Let P be a point on the surface B. δl is the perpendicular distance of the surface A from P. Imagine that a unit positive charge is moved along this perpendicular from the surface B to surface A against the electric field. The work done in this process is $|\mathbf{E}| \delta l$.

This work equals the potential difference $V_A - V_B$.

Thus,

$$|\mathbf{E}| \delta l = V - (V + \delta V) = -\delta V$$

$$\text{i.e., } |\mathbf{E}| = -\frac{\delta V}{\delta l} \quad (2.20)$$

Since δV is negative, $\delta V = -|\delta V|$. we can rewrite Eq (2.20) as

$$|\mathbf{E}| = -\frac{\delta V}{\delta l} = +\frac{|\delta V|}{\delta l} \quad (2.21)$$

We thus arrive at two important conclusions concerning the relation between electric field and potential:

- (i) *Electric field is in the direction in which the potential decreases steepest.*
- (ii) *Its magnitude is given by the change in the magnitude of potential per unit displacement normal to the equipotential surface at the point.*

2.7 POTENTIAL ENERGY OF A SYSTEM OF CHARGES

Consider first the simple case of two charges q_1 and q_2 with position vector \mathbf{r}_1 and \mathbf{r}_2 relative to some origin. Let us calculate the work done (externally) in building up this configuration. This means that we consider the charges q_1 and q_2 initially at infinity and determine the work done by an external agency to bring the charges to the given locations. Suppose, first the charge q_1 is brought from infinity to the point \mathbf{r}_1 . There is no external field against which work needs to be done, so work done in bringing q_1 from infinity to \mathbf{r}_1 is zero. This charge produces a potential in space given by

$$V_1 = \frac{1}{4\pi\epsilon_0} \frac{q_1}{r_{1P}}$$

where r_{1P} is the distance of a point P in space from the location of q_1 . From the definition of potential, work done in bringing charge q_2 from infinity to the point \mathbf{r}_2 is q_2 times the potential at \mathbf{r}_2 due to q_1 :

$$\text{work done on } q_2 = \frac{1}{4\pi\epsilon_0} \frac{q_1 q_2}{r_{12}}$$

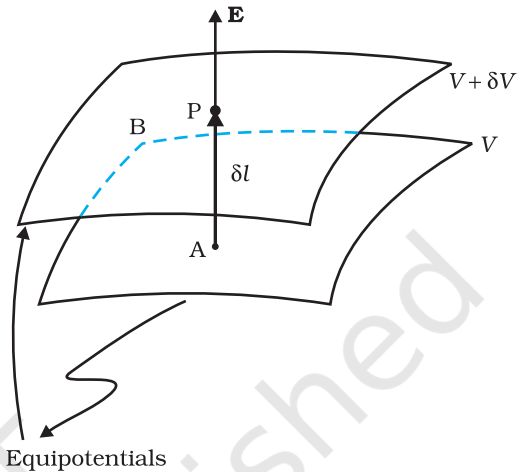

FIGURE 2.12 From the potential to the field.

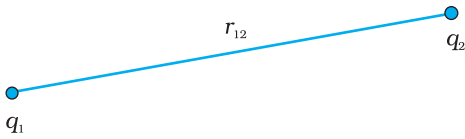

FIGURE 2.13 Potential energy of a system of charges q_1 and q_2 is directly proportional to the product of charges and inversely to the distance between them.

where r_{12} is the distance between points 1 and 2.

Since electrostatic force is conservative, this work gets stored in the form of potential energy of the system. Thus, the potential energy of a system of two charges q_1 and q_2 is

$$U = \frac{1}{4\pi\epsilon_0} \frac{q_1 q_2}{r_{12}} \quad (2.22)$$

Obviously, if q_2 was brought first to its present location and q_1 brought later, the potential energy U would be the same.

More generally, the potential energy expression, Eq. (2.22), is unaltered whatever way the charges are brought to the specified locations, because of path-independence of work for electrostatic force.

Equation (2.22) is true for any sign of q_1 and q_2 . If $q_1 q_2 > 0$, potential energy is positive. This is as expected, since for like charges ($q_1 q_2 > 0$), electrostatic force is repulsive and a positive amount of work is needed to be done against this force to bring the charges from infinity to a finite distance apart. For unlike charges ($q_1 q_2 < 0$), the electrostatic force is attractive. In that case, a positive amount of work is needed against this force to take the charges from the given location to infinity. In other words, a negative amount of work is needed for the reverse path (from infinity to the present locations), so the potential energy is negative.

Equation (2.22) is easily generalised for a system of any number of point charges. Let us calculate the potential energy of a system of three charges q_1, q_2 and q_3 located at $\mathbf{r}_1, \mathbf{r}_2, \mathbf{r}_3$, respectively. To bring q_1 first from infinity to \mathbf{r}_1 , no work is required. Next we bring q_2 from infinity to \mathbf{r}_2 . As before, work done in this step is

$$q_2 V_1(\mathbf{r}_2) = \frac{1}{4\pi\epsilon_0} \frac{q_1 q_2}{r_{12}} \quad (2.23)$$

The charges q_1 and q_2 produce a potential, which at any point P is given by

$$V_{1,2} = \frac{1}{4\pi\epsilon_0} \left(\frac{q_1}{r_{1P}} + \frac{q_2}{r_{2P}} \right) \quad (2.24)$$

Work done next in bringing q_3 from infinity to the point \mathbf{r}_3 is q_3 times $V_{1,2}$ at \mathbf{r}_3

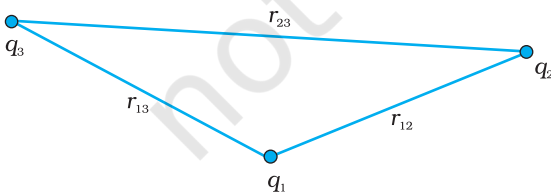

FIGURE 2.14 Potential energy of a system of three charges is given by Eq. (2.26), with the notation given in the figure.

$$q_3 V_{1,2}(\mathbf{r}_3) = \frac{1}{4\pi\epsilon_0} \left(\frac{q_1 q_3}{r_{13}} + \frac{q_2 q_3}{r_{23}} \right) \quad (2.25)$$

The total work done in assembling the charges at the given locations is obtained by adding the work done in different steps [Eq. (2.23) and Eq. (2.25)],

$$U = \frac{1}{4\pi\epsilon_0} \left(\frac{q_1 q_2}{r_{12}} + \frac{q_1 q_3}{r_{13}} + \frac{q_2 q_3}{r_{23}} \right) \quad (2.26)$$

Again, because of the conservative nature of the electrostatic force (or equivalently, the path independence of work done), the final expression for U , Eq. (2.26), is independent of the manner in which the configuration is assembled. *The potential energy*

is characteristic of the present state of configuration, and not the way the state is achieved.

Example 2.4 Four charges are arranged at the corners of a square ABCD of side d , as shown in Fig. 2.15. (a) Find the work required to put together this arrangement. (b) A charge q_0 is brought to the centre E of the square, the four charges being held fixed at its corners. How much extra work is needed to do this?

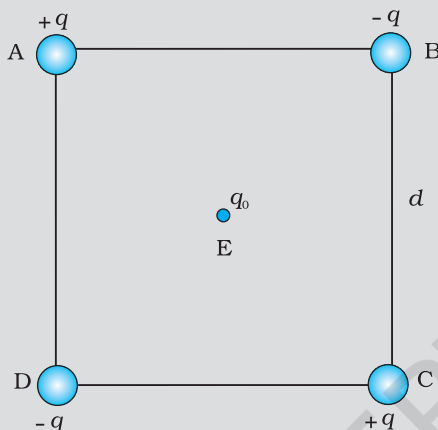

FIGURE 2.15

Solution

(a) Since the work done depends on the final arrangement of the charges, and not on how they are put together, we calculate work needed for one way of putting the charges at A, B, C and D. Suppose, first the charge $+q$ is brought to A, and then the charges $-q$, $+q$, and $-q$ are brought to B, C and D, respectively. The total work needed can be calculated in steps:

(i) Work needed to bring charge $+q$ to A when no charge is present elsewhere: this is zero.

(ii) Work needed to bring $-q$ to B when $+q$ is at A. This is given by (charge at B) \times (electrostatic potential at B due to charge $+q$ at A)

$$= -q \times \left(\frac{q}{4\pi\epsilon_0 d} \right) = -\frac{q^2}{4\pi\epsilon_0 d}$$

(iii) Work needed to bring charge $+q$ to C when $+q$ is at A and $-q$ is at B. This is given by (charge at C) \times (potential at C due to charges at A and B)

$$= +q \left(\frac{+q}{4\pi\epsilon_0 d\sqrt{2}} + \frac{-q}{4\pi\epsilon_0 d} \right)$$

$$= \frac{-q^2}{4\pi\epsilon_0 d} \left(1 - \frac{1}{\sqrt{2}} \right)$$

(iv) Work needed to bring $-q$ to D when $+q$ at A, $-q$ at B, and $+q$ at C. This is given by (charge at D) \times (potential at D due to charges at A, B and C)

$$= -q \left(\frac{+q}{4\pi\epsilon_0 d} + \frac{-q}{4\pi\epsilon_0 d\sqrt{2}} + \frac{q}{4\pi\epsilon_0 d} \right)$$

$$= \frac{-q^2}{4\pi\epsilon_0 d} \left(2 - \frac{1}{\sqrt{2}} \right)$$

EXAMPLE 2.4

Add the work done in steps (i), (ii), (iii) and (iv). The total work required is

$$\begin{aligned}
 &= \frac{-q^2}{4\pi\epsilon_0 d} \left\{ (0) + (1) + \left(1 - \frac{1}{\sqrt{2}}\right) + \left(2 - \frac{1}{\sqrt{2}}\right) \right\} \\
 &= \frac{-q^2}{4\pi\epsilon_0 d} (4 - \sqrt{2})
 \end{aligned}$$

The work done depends only on the arrangement of the charges, and not how they are assembled. By definition, this is the total electrostatic energy of the charges.

(Students may try calculating same work/energy by taking charges in any other order they desire and convince themselves that the energy will remain the same.)

(b) The extra work necessary to bring a charge q_0 to the point E when the four charges are at A, B, C and D is $q_0 \times$ (electrostatic potential at E due to the charges at A, B, C and D). The electrostatic potential at E is clearly zero since potential due to A and C is cancelled by that due to B and D. Hence, no work is required to bring any charge to point E.

2.8 POTENTIAL ENERGY IN AN EXTERNAL FIELD

2.8.1 Potential energy of a single charge

In Section 2.7, the source of the electric field was specified – the charges and their locations - and the potential energy of the system of those charges was determined. In this section, we ask a related but a distinct question. What is the potential energy of a charge q in a given field? This question was, in fact, the starting point that led us to the notion of the electrostatic potential (Sections 2.1 and 2.2). But here we address this question again to clarify in what way it is different from the discussion in Section 2.7.

The main difference is that we are now concerned with the potential energy of a charge (or charges) in an *external* field. The external field \mathbf{E} is *not* produced by the given charge(s) whose potential energy we wish to calculate. \mathbf{E} is produced by sources external to the given charge(s). The external sources may be known, but often they are unknown or unspecified; what is specified is the electric field \mathbf{E} or the electrostatic potential V due to the external sources. We assume that the charge q does not significantly affect the sources producing the external field. This is true if q is very small, or the external sources are held fixed by other unspecified forces. Even if q is finite, its influence on the external sources may still be ignored in the situation when very strong sources far away at infinity produce a finite field \mathbf{E} in the region of interest. Note again that we are interested in determining the potential energy of a given charge q (and later, a system of charges) in the external field; we are not interested in the potential energy of the sources producing the external electric field.

The external electric field \mathbf{E} and the corresponding external potential V may vary from point to point. By definition, V at a point P is the work done in bringing a unit positive charge from infinity to the point P.

(We continue to take potential at infinity to be zero.) Thus, work done in bringing a charge q from infinity to the point P in the external field is qV . This work is stored in the form of potential energy of q . If the point P has position vector \mathbf{r} relative to some origin, we can write:

$$\begin{aligned} &\text{Potential energy of } q \text{ at } \mathbf{r} \text{ in an external field} \\ &= qV(\mathbf{r}) \end{aligned} \quad (2.27)$$

where $V(\mathbf{r})$ is the external potential at the point \mathbf{r} .

Thus, if an electron with charge $q = e = 1.6 \times 10^{-19} \text{ C}$ is accelerated by a potential difference of $\Delta V = 1 \text{ volt}$, it would gain energy of $q\Delta V = 1.6 \times 10^{-19} \text{ J}$. This unit of energy is defined as 1 *electron volt* or 1eV, i.e., $1 \text{ eV} = 1.6 \times 10^{-19} \text{ J}$. The units based on eV are most commonly used in atomic, nuclear and particle physics, ($1 \text{ keV} = 10^3 \text{ eV} = 1.6 \times 10^{-16} \text{ J}$, $1 \text{ MeV} = 10^6 \text{ eV} = 1.6 \times 10^{-13} \text{ J}$, $1 \text{ GeV} = 10^9 \text{ eV} = 1.6 \times 10^{-10} \text{ J}$ and $1 \text{ TeV} = 10^{12} \text{ eV} = 1.6 \times 10^{-7} \text{ J}$). [This has already been defined on Page 117, XI Physics Part I, Table 6.1.]

2.8.2 Potential energy of a system of two charges in an external field

Next, we ask: what is the potential energy of a system of two charges q_1 and q_2 located at \mathbf{r}_1 and \mathbf{r}_2 , respectively, in an external field? First, we calculate the work done in bringing the charge q_1 from infinity to \mathbf{r}_1 . Work done in this step is $q_1 V(\mathbf{r}_1)$, using Eq. (2.27). Next, we consider the work done in bringing q_2 to \mathbf{r}_2 . In this step, work is done not only against the external field \mathbf{E} but also against the field due to q_1 .

Work done on q_2 against the external field

$$= q_2 V(\mathbf{r}_2)$$

Work done on q_2 against the field due to q_1

$$= \frac{q_1 q_2}{4\pi\epsilon_0 r_{12}}$$

where r_{12} is the distance between q_1 and q_2 . We have made use of Eqs. (2.27) and (2.22). By the superposition principle for fields, we add up the work done on q_2 against the two fields (\mathbf{E} and that due to q_1):

Work done in bringing q_2 to \mathbf{r}_2

$$= q_2 V(\mathbf{r}_2) + \frac{q_1 q_2}{4\pi\epsilon_0 r_{12}} \quad (2.28)$$

Thus,

Potential energy of the system

= the total work done in assembling the configuration

$$= q_1 V(\mathbf{r}_1) + q_2 V(\mathbf{r}_2) + \frac{q_1 q_2}{4\pi\epsilon_0 r_{12}} \quad (2.29)$$

Example 2.5

- (a) Determine the electrostatic potential energy of a system consisting of two charges $7 \mu\text{C}$ and $-2 \mu\text{C}$ (and with no external field) placed at $(-9 \text{ cm}, 0, 0)$ and $(9 \text{ cm}, 0, 0)$ respectively.
- (b) How much work is required to separate the two charges infinitely away from each other?

(c) Suppose that the same system of charges is now placed in an external electric field $E = A(1/r^2)$; $A = 9 \times 10^5 \text{ NC}^{-1} \text{ m}^2$. What would the electrostatic energy of the configuration be?

Solution

(a) $U = \frac{1}{4\pi\epsilon_0} \frac{q_1 q_2}{r} = 9 \times 10^9 \times \frac{7 \times (-2) \times 10^{-12}}{0.18} = -0.7 \text{ J}$.

(b) $W = U_2 - U_1 = 0 - U = 0 - (-0.7) = 0.7 \text{ J}$.

(c) The mutual interaction energy of the two charges remains unchanged. In addition, there is the energy of interaction of the two charges with the external electric field. We find,

$$q_1 V(\mathbf{r}_1) + q_2 V(\mathbf{r}_2) = A \frac{7\mu\text{C}}{0.09\text{m}} + A \frac{-2\mu\text{C}}{0.09\text{m}}$$

and the net electrostatic energy is

$$q_1 V(\mathbf{r}_1) + q_2 V(\mathbf{r}_2) + \frac{q_1 q_2}{4\pi\epsilon_0 r_{12}} = A \frac{7\mu\text{C}}{0.09\text{m}} + A \frac{-2\mu\text{C}}{0.09\text{m}} - 0.7 \text{ J}$$

$$= 70 - 20 - 0.7 = 49.3 \text{ J}$$

2.8.3 Potential energy of a dipole in an external field

Consider a dipole with charges $q_1 = +q$ and $q_2 = -q$ placed in a uniform electric field \mathbf{E} , as shown in Fig. 2.16.

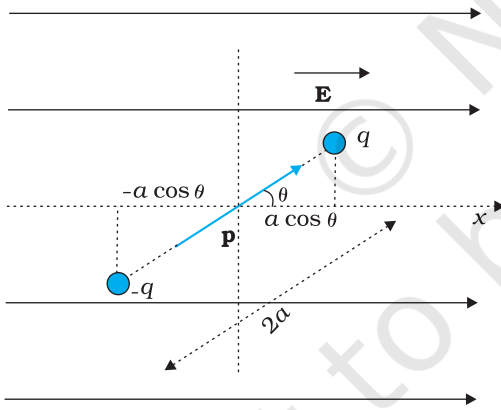

FIGURE 2.16 Potential energy of a dipole in a uniform external field.

As seen in the last chapter, in a uniform electric field, the dipole experiences no net force; but experiences a torque τ given by

$$\tau = \mathbf{p} \times \mathbf{E} \tag{2.30}$$

which will tend to rotate it (unless \mathbf{p} is parallel or antiparallel to \mathbf{E}). Suppose an external torque τ_{ext} is applied in such a manner that it just neutralises this torque and rotates it in the plane of paper from angle θ_0 to angle θ_1 at an infinitesimal angular speed and *without angular acceleration*. The amount of work done by the external torque will be given by

$$W = \int_{\theta_0}^{\theta_1} t_{\text{ext}}(\theta) d\theta = \int_{\theta_0}^{\theta_1} pE \sin \theta d\theta$$

$$= pE(\cos \theta_0 - \cos \theta_1) \tag{2.31}$$

This work is stored as the potential energy of the system. We can then associate potential energy $U(\theta)$ with an inclination θ of the dipole. Similar to other potential energies, there is a freedom in choosing the angle where the potential energy U is taken to be zero. A natural choice is to take $\theta_0 = \pi/2$. (An explanation for it is provided towards the end of discussion.) We can then write,

$$U(\theta) = pE \left(\cos \frac{\pi}{2} - \cos \theta \right) = pE \cos \theta = -\mathbf{p} \cdot \mathbf{E} \tag{2.32}$$

This expression can alternately be understood also from Eq. (2.29). We apply Eq. (2.29) to the present system of two charges $+q$ and $-q$. The potential energy expression then reads

$$U'(\theta) = q[V(\mathbf{r}_1) - V(\mathbf{r}_2)] - \frac{q^2}{4\pi\epsilon_0 \times 2a} \quad (2.33)$$

Here, \mathbf{r}_1 and \mathbf{r}_2 denote the position vectors of $+q$ and $-q$. Now, the potential difference between positions \mathbf{r}_1 and \mathbf{r}_2 equals the work done in bringing a unit positive charge against field from \mathbf{r}_2 to \mathbf{r}_1 . The displacement parallel to the force is $2a \cos\theta$. Thus, $[V(\mathbf{r}_1) - V(\mathbf{r}_2)] = -E \times 2a \cos\theta$. We thus obtain,

$$U'(\theta) = -pE \cos\theta - \frac{q^2}{4\pi\epsilon_0 \times 2a} = -\mathbf{p} \cdot \mathbf{E} - \frac{q^2}{4\pi\epsilon_0 \times 2a} \quad (2.34)$$

We note that $U'(\theta)$ differs from $U(\theta)$ by a quantity which is just a constant for a given dipole. Since a constant is insignificant for potential energy, we can drop the second term in Eq. (2.34) and it then reduces to Eq. (2.32).

We can now understand why we took $\theta_0 = \pi/2$. In this case, the work done against the *external* field \mathbf{E} in bringing $+q$ and $-q$ are equal and opposite and cancel out, i.e., $q[V(\mathbf{r}_1) - V(\mathbf{r}_2)] = 0$.

Example 2.6 A molecule of a substance has a permanent electric dipole moment of magnitude 10^{-29} C m. A mole of this substance is polarised (at low temperature) by applying a strong electrostatic field of magnitude 10^6 V m⁻¹. The direction of the field is suddenly changed by an angle of 60° . Estimate the heat released by the substance in aligning its dipoles along the new direction of the field. For simplicity, assume 100% polarisation of the sample.

Solution Here, dipole moment of each molecules = 10^{-29} C m
As 1 mole of the substance contains 6×10^{23} molecules,
total dipole moment of all the molecules, $p = 6 \times 10^{23} \times 10^{-29}$ C m
 $= 6 \times 10^{-6}$ C m

Initial potential energy, $U_i = -pE \cos\theta = -6 \times 10^{-6} \times 10^6 \cos 0^\circ = -6$ J
Final potential energy (when $\theta = 60^\circ$), $U_f = -6 \times 10^{-6} \times 10^6 \cos 60^\circ = -3$ J
Change in potential energy = -3 J - $(-6$ J) = 3 J
So, there is loss in potential energy. This must be the energy released by the substance in the form of heat in aligning its dipoles.

EXAMPLE 2.6

2.9 ELECTROSTATICS OF CONDUCTORS

Conductors and insulators were described briefly in Chapter 1. Conductors contain mobile charge carriers. In metallic conductors, these charge carriers are electrons. In a metal, the outer (valence) electrons part away from their atoms and are free to move. These electrons are free within the metal but not free to leave the metal. The free electrons form a kind of 'gas'; they collide with each other and with the ions, and move randomly in different directions. In an external electric field, they drift against the direction of the field. The positive ions made up of the nuclei and the bound electrons remain held in their fixed positions. In electrolytic conductors, the charge carriers are both positive and negative ions; but

the situation in this case is more involved – the movement of the charge carriers is affected both by the external electric field as also by the so-called chemical forces (see Chapter 3). We shall restrict our discussion to metallic solid conductors. Let us note important results regarding electrostatics of conductors.

1. Inside a conductor, electrostatic field is zero

Consider a conductor, neutral or charged. There may also be an external electrostatic field. In the static situation, when there is no current inside or on the surface of the conductor, the electric field is zero everywhere inside the conductor. This fact can be taken as the defining property of a conductor. A conductor has free electrons. As long as electric field is not zero, the free charge carriers would experience force and drift. In the static situation, the free charges have so distributed themselves that the electric field is zero everywhere inside. *Electrostatic field is zero inside a conductor.*

2. At the surface of a charged conductor, electrostatic field must be normal to the surface at every point

If \mathbf{E} were not normal to the surface, it would have some non-zero component along the surface. Free charges on the surface of the conductor would then experience force and move. In the static situation, therefore, \mathbf{E} should have no tangential component. Thus *electrostatic field at the surface of a charged conductor must be normal to the surface at every point.* (For a conductor without any surface charge density, field is zero even at the surface.) See result 5.

3. The interior of a conductor can have no excess charge in the static situation

A neutral conductor has equal amounts of positive and negative charges in every small volume or surface element. When the conductor is charged, the excess charge can reside only on the surface in the static situation. This follows from the Gauss's law. Consider any arbitrary volume element v inside a conductor. On the closed surface S bounding the volume element v , electrostatic field is zero. Thus the total electric flux through S is zero. Hence, by Gauss's law, there is no net charge enclosed by S . But the surface S can be made as small as you like, i.e., the volume v can be made vanishingly small. This means *there is no net charge at any point inside the conductor, and any excess charge must reside at the surface.*

4. Electrostatic potential is constant throughout the volume of the conductor and has the same value (as inside) on its surface

This follows from results 1 and 2 above. Since $\mathbf{E} = 0$ inside the conductor and has no tangential component on the surface, no work is done in moving a small test charge within the conductor and on its surface. That is, there is no potential difference between any two points inside or on the surface of the conductor. Hence, the result. If the conductor is charged,

electric field normal to the surface exists; this means potential will be different for the surface and a point just outside the surface.

In a system of conductors of arbitrary size, shape and charge configuration, each conductor is characterised by a constant value of potential, but this constant may differ from one conductor to the other.

5. Electric field at the surface of a charged conductor

$$\mathbf{E} = \frac{\sigma}{\epsilon_0} \hat{\mathbf{n}} \quad (2.35)$$

where σ is the surface charge density and $\hat{\mathbf{n}}$ is a unit vector normal to the surface in the outward direction.

To derive the result, choose a pill box (a short cylinder) as the Gaussian surface about any point P on the surface, as shown in Fig. 2.17. The pill box is partly inside and partly outside the surface of the conductor. It has a small area of cross section δS and negligible height.

Just inside the surface, the electrostatic field is zero; just outside, the field is normal to the surface with magnitude E . Thus, the contribution to the total flux through the pill box comes only from the outside (circular) cross-section of the pill box. This equals $\pm E\delta S$ (positive for $\sigma > 0$, negative for $\sigma < 0$), since over the small area δS , \mathbf{E} may be considered constant and \mathbf{E} and δS are parallel or antiparallel. The charge enclosed by the pill box is $\sigma\delta S$.

By Gauss's law

$$E\delta S = \frac{|\sigma|\delta S}{\epsilon_0}$$

$$E = \frac{|\sigma|}{\epsilon_0} \quad (2.36)$$

Including the fact that electric field is normal to the surface, we get the vector relation, Eq. (2.35), which is true for both signs of σ . For $\sigma > 0$, electric field is normal to the surface outward; for $\sigma < 0$, electric field is normal to the surface inward.

6. Electrostatic shielding

Consider a conductor with a cavity, with no charges inside the cavity. A remarkable result is that the electric field inside the cavity is zero, whatever be the size and shape of the cavity and whatever be the charge on the conductor and the external fields in which it might be placed. We have proved a simple case of this result already: the electric field inside a charged spherical shell is zero. The proof of the result for the shell makes use of the spherical symmetry of the shell (see Chapter 1). But the vanishing of electric field in the (charge-free) cavity of a conductor is, as mentioned above, a very general result. A related result is that even if the conductor

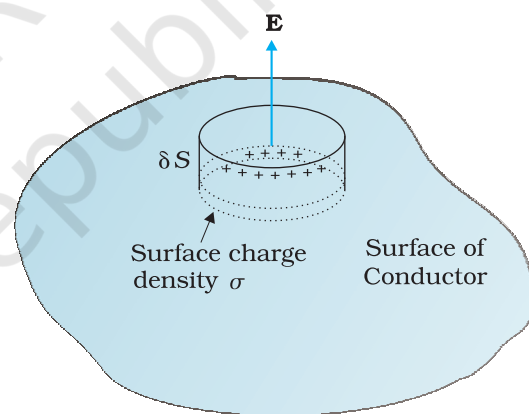

FIGURE 2.17 The Gaussian surface (a pill box) chosen to derive Eq. (2.35) for electric field at the surface of a charged conductor.

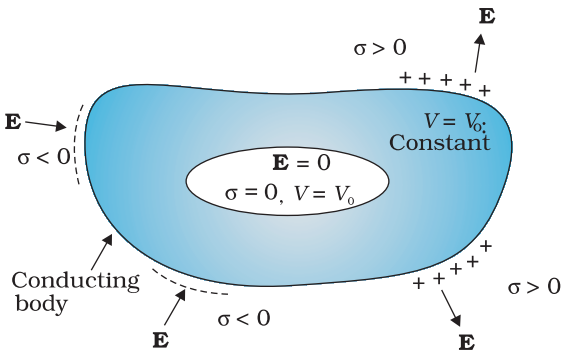

FIGURE 2.18 The electric field inside a cavity of any conductor is zero. All charges reside only on the outer surface of a conductor with cavity. (There are no charges placed in the cavity.)

is charged or charges are induced on a neutral conductor by an external field, all charges reside only on the outer surface of a conductor with cavity.

The proofs of the results noted in Fig. 2.18 are omitted here, but we note their important implication. Whatever be the charge and field configuration outside, any cavity in a conductor remains shielded from outside electric influence: *the field inside the cavity is always zero*. This is known as *electrostatic shielding*. The effect can be made use of in protecting sensitive instruments from outside electrical influence. Figure 2.19 gives a summary of the important electrostatic properties of a conductor.

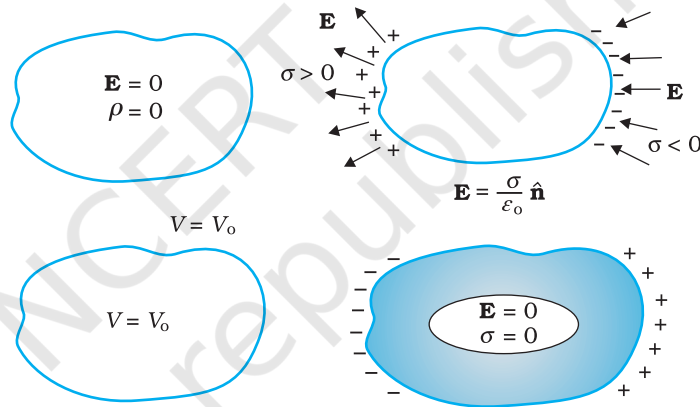

FIGURE 2.19 Some important electrostatic properties of a conductor.

Example 2.7

- (a) A comb run through one's dry hair attracts small bits of paper. Why? What happens if the hair is wet or if it is a rainy day? (Remember, a paper does not conduct electricity.)
- (b) Ordinary rubber is an insulator. But special rubber tyres of aircraft are made slightly conducting. Why is this necessary?
- (c) Vehicles carrying inflammable materials usually have metallic ropes touching the ground during motion. Why?
- (d) A bird perches on a bare high power line, and nothing happens to the bird. A man standing on the ground touches the same line and gets a fatal shock. Why?

Solution

- (a) This is because the comb gets charged by friction. The molecules in the paper gets polarised by the charged comb, resulting in a net force of attraction. If the hair is wet, or if it is rainy day, friction between hair and the comb reduces. The comb does not get charged and thus it will not attract small bits of paper.

EXAMPLE 2.7

- (b) To enable them to conduct charge (produced by friction) to the ground; as too much of static electricity accumulated may result in spark and result in fire.
- (c) Reason similar to (b).
- (d) Current passes only when there is difference in potential.

EXAMPLE 2.7

2.10 DIELECTRICS AND POLARISATION

Dielectrics are non-conducting substances. In contrast to conductors, they have no (or negligible number of) charge carriers. Recall from Section 2.9 what happens when a conductor is placed in an external electric field. The free charge carriers move and charge distribution in the conductor adjusts itself in such a way that the electric field due to induced charges opposes the external field within the conductor. This happens until, in the static situation, the two fields cancel each other and the net electrostatic field in the conductor is zero. In a dielectric, this free movement of charges is not possible. It turns out that the external field induces dipole moment by stretching or re-orienting molecules of the dielectric. The collective effect of all the molecular dipole moments is net charges on the surface of the dielectric which produce a field that opposes the external field. Unlike in a conductor, however, the opposing field so induced does not exactly cancel the external field. It only reduces it. The extent of the effect depends on the nature of the dielectric. To understand the effect, we need to look at the charge distribution of a dielectric at the molecular level.

The molecules of a substance may be polar or non-polar. In a non-polar molecule, the centres of positive and negative charges coincide. The molecule then has no permanent (or intrinsic) dipole moment. Examples of non-polar molecules are oxygen (O_2) and hydrogen (H_2) molecules which, because of their symmetry, have no dipole moment. On the other hand, a polar molecule is one in which the centres of positive and negative charges are separated (even when there is no external field). Such molecules have a permanent dipole moment. An ionic molecule such as HCl or a molecule of water (H_2O) are examples of polar molecules.

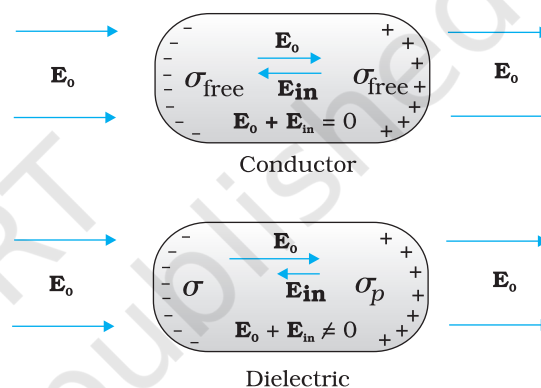

FIGURE 2.20 Difference in behaviour of a conductor and a dielectric in an external electric field.

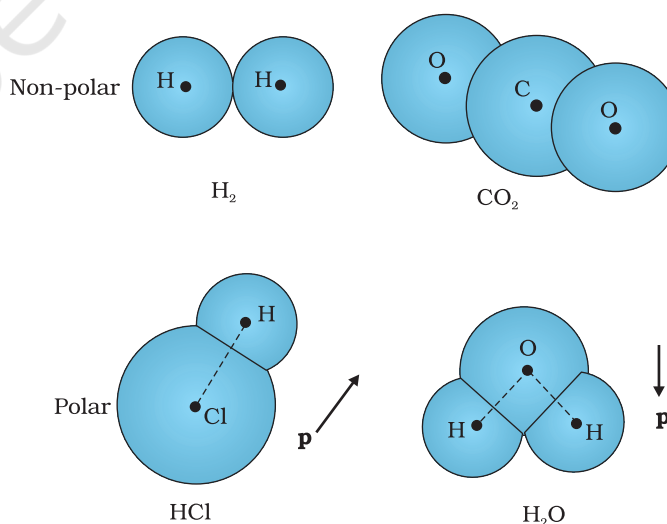

FIGURE 2.21 Some examples of polar and non-polar molecules.

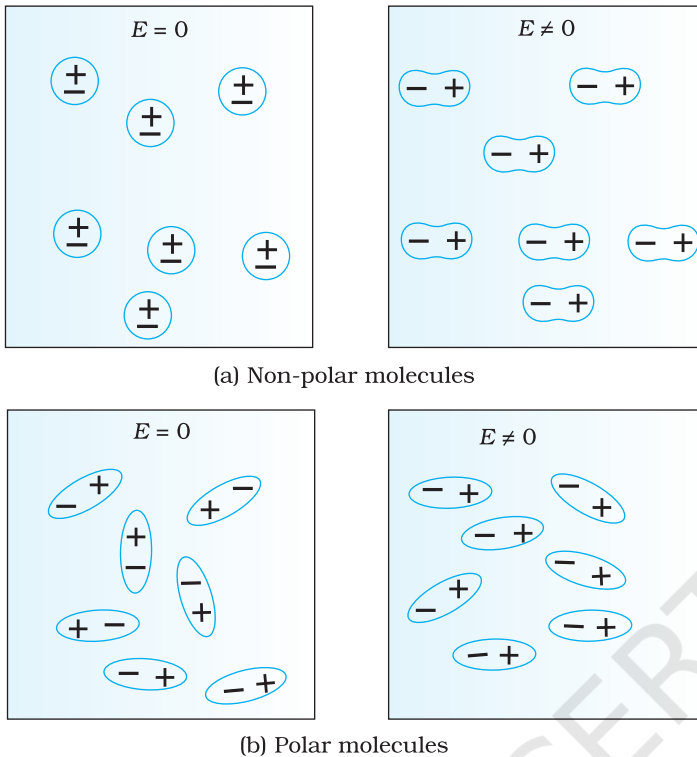

FIGURE 2.22 A dielectric develops a net dipole moment in an external electric field. (a) Non-polar molecules, (b) Polar molecules.

In an external electric field, the positive and negative charges of a non-polar molecule are displaced in opposite directions. The displacement stops when the external force on the constituent charges of the molecule is balanced by the restoring force (due to internal fields in the molecule). The non-polar molecule thus develops an induced dipole moment. The dielectric is said to be polarised by the external field. We consider only the simple situation when the induced dipole moment is in the direction of the field and is proportional to the field strength. (Substances for which this assumption is true are called *linear isotropic dielectrics*.) The induced dipole moments of different molecules add up giving a net dipole moment of the dielectric in the presence of the external field.

A dielectric with polar molecules also develops a net dipole moment in an external field, but for a different reason. In the absence of any external field, the different permanent dipoles are oriented randomly due to thermal agitation; so the total dipole moment is zero. When

an external field is applied, the individual dipole moments tend to align with the field. When summed overall the molecules, there is then a net dipole moment in the direction of the external field, i.e., the dielectric is polarised. The extent of polarisation depends on the relative strength of two mutually opposite factors: the dipole potential energy in the external field tending to align the dipoles with the field and thermal energy tending to disrupt the alignment. There may be, in addition, the ‘induced dipole moment’ effect as for non-polar molecules, but generally the alignment effect is more important for polar molecules.

Thus in either case, whether polar or non-polar, a dielectric develops a net dipole moment in the presence of an external field. The dipole moment per unit volume is called *polarisation* and is denoted by \mathbf{P} . For linear isotropic dielectrics,

$$\mathbf{P} = \epsilon_0 \chi_e \mathbf{E} \quad (2.37)$$

where χ_e is a constant characteristic of the dielectric and is known as the *electric susceptibility* of the dielectric medium.

It is possible to relate χ_e to the molecular properties of the substance, but we shall not pursue that here.

The question is: how does the polarised dielectric modify the original external field inside it? Let us consider, for simplicity, a rectangular dielectric slab placed in a uniform external field \mathbf{E}_0 parallel to two of its faces. The field causes a uniform polarisation \mathbf{P} of the dielectric. Thus

every volume element ΔV of the slab has a dipole moment $\mathbf{P} \Delta V$ in the direction of the field. The volume element ΔV is macroscopically small but contains a very large number of molecular dipoles. Anywhere inside the dielectric, the volume element ΔV has no net charge (though it has net dipole moment). This is, because, the positive charge of one dipole sits close to the negative charge of the adjacent dipole. However, at the surfaces of the dielectric normal to the electric field, there is evidently a net charge density. As seen in Fig 2.23, the positive ends of the dipoles remain unneutralised at the right surface and the negative ends at the left surface. The unbalanced charges are the induced charges due to the external field.

Thus, the polarised dielectric is equivalent to two charged surfaces with induced surface charge densities, say σ_p and $-\sigma_p$. Clearly, the field produced by these surface charges opposes the external field. The total field in the dielectric is, thereby, reduced from the case when no dielectric is present. We should note that the surface charge density $\pm\sigma_p$ arises from bound (not free charges) in the dielectric.

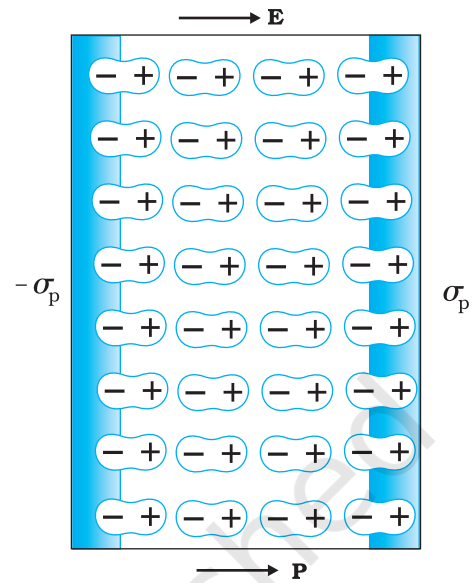

FIGURE 2.23 A uniformly polarised dielectric amounts to induced surface charge density, but no volume charge density.

2.11 CAPACITORS AND CAPACITANCE

A capacitor is a system of two conductors separated by an insulator (Fig. 2.24). The conductors have charges, say Q_1 and Q_2 , and potentials V_1 and V_2 . Usually, in practice, the two conductors have charges Q and $-Q$, with potential difference $V = V_1 - V_2$ between them. We shall consider only this kind of charge configuration of the capacitor. (Even a single conductor can be used as a capacitor by assuming the other at infinity.) The conductors may be so charged by connecting them to the two terminals of a battery. Q is called the charge of the capacitor, though this, in fact, is the charge on one of the conductors – the total charge of the capacitor is zero.

The electric field in the region between the conductors is proportional to the charge Q . That is, if the charge on the capacitor is, say doubled, the electric field will also be doubled at every point. (This follows from the direct proportionality between field and charge implied by Coulomb's law and the superposition principle.) Now, potential difference V is the work done per unit positive charge in taking a small test charge from the conductor 2 to 1 against the field. Consequently, V is also proportional to Q , and the ratio Q/V is a constant:

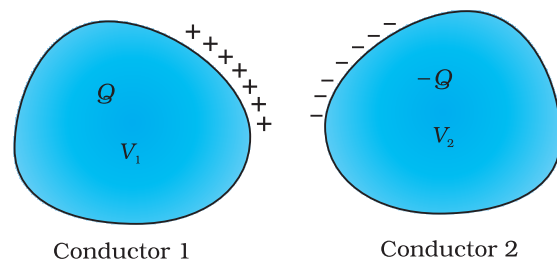

FIGURE 2.24 A system of two conductors separated by an insulator forms a capacitor.

$$C = \frac{Q}{V} \quad (2.38)$$

The constant C is called the *capacitance* of the capacitor. C is independent of Q or V , as stated above. The capacitance C depends only on the

geometrical configuration (shape, size, separation) of the system of two conductors. [As we shall see later, it also depends on the nature of the insulator (dielectric) separating the two conductors.] The SI unit of capacitance is 1 farad (=1 coulomb volt⁻¹) or 1 F = 1 C V⁻¹. A capacitor with fixed capacitance is symbolically shown as $\text{—}| \text{—}$, while the one with variable capacitance is shown as $\text{—}| \text{—}$.

Equation (2.38) shows that for large C , V is small for a given Q . This means a capacitor with large capacitance can hold large amount of charge Q at a relatively small V . This is of practical importance. High potential difference implies strong electric field around the conductors. A strong electric field can ionise the surrounding air and accelerate the charges so produced to the oppositely charged plates, thereby neutralising the charge on the capacitor plates, at least partly. In other words, the charge of the capacitor leaks away due to the reduction in insulating power of the intervening medium.

The maximum electric field that a dielectric medium can withstand without break-down (of its insulating property) is called its *dielectric strength*; for air it is about $3 \times 10^6 \text{ Vm}^{-1}$. For a separation between conductors of the order of 1 cm or so, this field corresponds to a potential difference of $3 \times 10^4 \text{ V}$ between the conductors. Thus, for a capacitor to store a large amount of charge without leaking, its capacitance should be high enough so that the potential difference and hence the electric field do not exceed the break-down limits. Put differently, there is a limit to the amount of charge that can be stored on a given capacitor without significant leaking. In practice, a farad is a very big unit; the most common units are its sub-multiples $1 \mu\text{F} = 10^{-6} \text{ F}$, $1 \text{ nF} = 10^{-9} \text{ F}$, $1 \text{ pF} = 10^{-12} \text{ F}$, etc. Besides its use in storing charge, a capacitor is a key element of most ac circuits with important functions, as described in Chapter 7.

2.12 THE PARALLEL PLATE CAPACITOR

A parallel plate capacitor consists of two large plane parallel conducting plates separated by a small distance (Fig. 2.25). We first take the intervening medium between the plates to be vacuum. The effect of a dielectric medium between the plates is discussed in the next section. Let A be the area of each plate and d the separation between them. The two plates have charges Q and $-Q$. Since d is much smaller than the linear dimension of the plates ($d^2 \ll A$), we can use the result on electric field by an infinite plane sheet of uniform surface charge density (Section 1.15). Plate 1 has surface charge density $\sigma = Q/A$ and plate 2 has a surface charge density $-\sigma$. Using Eq. (1.33), the electric field in different regions is:

Outer region I (region above the plate 1),

$$E = \frac{\sigma}{2\epsilon_0} - \frac{\sigma}{2\epsilon_0} = 0 \tag{2.39}$$

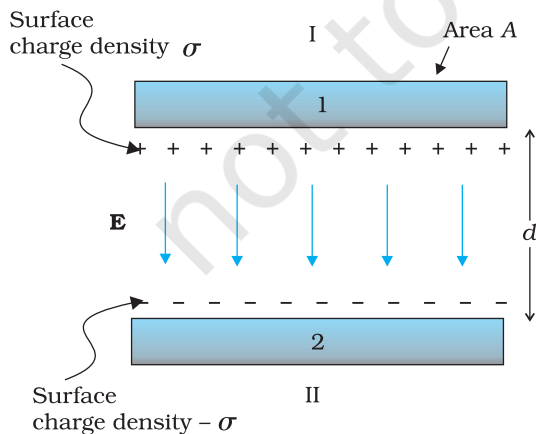

FIGURE 2.25 The parallel plate capacitor.

Outer region II (region below the plate 2),

$$E = \frac{\sigma}{2\epsilon_0} - \frac{\sigma}{2\epsilon_0} = 0 \quad (2.40)$$

In the inner region between the plates 1 and 2, the electric fields due to the two charged plates add up, giving

$$E = \frac{\sigma}{2\epsilon_0} + \frac{\sigma}{2\epsilon_0} = \frac{\sigma}{\epsilon_0} = \frac{Q}{\epsilon_0 A} \quad (2.41)$$

The direction of electric field is from the positive to the negative plate.

Thus, the electric field is localised between the two plates and is uniform throughout. For plates with finite area, this will not be true near the outer boundaries of the plates. The field lines bend outward at the edges — an effect called ‘fringing of the field’. By the same token, σ will not be strictly uniform on the entire plate. [E and σ are related by Eq. (2.35).] However, for $d^2 \ll A$, these effects can be ignored in the regions sufficiently far from the edges, and the field there is given by Eq. (2.41). Now for uniform electric field, potential difference is simply the electric field times the distance between the plates, that is,

$$V = Ed = \frac{1}{\epsilon_0} \frac{Qd}{A} \quad (2.42)$$

The capacitance C of the parallel plate capacitor is then

$$C = \frac{Q}{V} = \frac{\epsilon_0 A}{d} \quad (2.43)$$

which, as expected, depends only on the geometry of the system. For typical values like $A = 1 \text{ m}^2$, $d = 1 \text{ mm}$, we get

$$C = \frac{8.85 \times 10^{-12} \text{ C}^2 \text{ N}^{-1} \text{ m}^{-2} \times 1 \text{ m}^2}{10^{-3} \text{ m}} = 8.85 \times 10^{-9} \text{ F} \quad (2.44)$$

(You can check that if $1\text{F} = 1\text{C V}^{-1} = 1\text{C (NC}^{-1}\text{m)}^{-1} = 1\text{C}^2 \text{ N}^{-1}\text{m}^{-1}$.) This shows that 1F is too big a unit in practice, as remarked earlier. Another way of seeing the ‘bigness’ of 1F is to calculate the area of the plates needed to have $C = 1\text{F}$ for a separation of, say 1 cm :

$$A = \frac{Cd}{\epsilon_0} = \frac{1\text{F} \times 10^{-2} \text{ m}}{8.85 \times 10^{-12} \text{ C}^2 \text{ N}^{-1} \text{ m}^{-2}} = 10^9 \text{ m}^2 \quad (2.45)$$

which is a plate about 30 km in length and breadth!

2.13 EFFECT OF DIELECTRIC ON CAPACITANCE

With the understanding of the behaviour of dielectrics in an external field developed in Section 2.10, let us see how the capacitance of a parallel plate capacitor is modified when a dielectric is present. As before, we have two large plates, each of area A , separated by a distance d . The charge on the plates is $\pm Q$, corresponding to the charge density $\pm\sigma$ (with $\sigma = Q/A$). When there is vacuum between the plates,

$$E_0 = \frac{\sigma}{\epsilon_0}$$

PHYSICS

Factors affecting capacitance, capacitors in action
Interactive Java tutorial
<http://micro.magnet.fsu.edu/electromag/java/capacitance/>

and the potential difference V_0 is

$$V_0 = E_0 d$$

The capacitance C_0 in this case is

$$C_0 = \frac{Q}{V_0} = \epsilon_0 \frac{A}{d} \quad (2.46)$$

Consider next a dielectric inserted between the plates fully occupying the intervening region. The dielectric is polarised by the field and, as explained in Section 2.10, the effect is equivalent to two charged sheets (at the surfaces of the dielectric normal to the field) with surface charge densities σ_p and $-\sigma_p$. The electric field in the dielectric then corresponds to the case when the net surface charge density on the plates is $\pm(\sigma - \sigma_p)$. That is,

$$E = \frac{\sigma - \sigma_p}{\epsilon_0} \quad (2.47)$$

so that the potential difference across the plates is

$$V = E d = \frac{\sigma - \sigma_p}{\epsilon_0} d \quad (2.48)$$

For linear dielectrics, we expect σ_p to be proportional to E_0 , i.e., to σ . Thus, $(\sigma - \sigma_p)$ is proportional to σ and we can write

$$\sigma - \sigma_p = \frac{\sigma}{K} \quad (2.49)$$

where K is a constant characteristic of the dielectric. Clearly, $K > 1$. We then have

$$V = \frac{\sigma d}{\epsilon_0 K} = \frac{Qd}{A\epsilon_0 K} \quad (2.50)$$

The capacitance C , with dielectric between the plates, is then

$$C = \frac{Q}{V} = \frac{\epsilon_0 KA}{d} \quad (2.51)$$

The product $\epsilon_0 K$ is called the *permittivity* of the medium and is denoted by ϵ

$$\epsilon = \epsilon_0 K \quad (2.52)$$

For vacuum $K = 1$ and $\epsilon = \epsilon_0$; ϵ_0 is called the *permittivity of the vacuum*. The dimensionless ratio

$$K = \frac{\epsilon}{\epsilon_0} \quad (2.53)$$

is called the *dielectric constant* of the substance. As remarked before, from Eq. (2.49), it is clear that K is greater than 1. From Eqs. (2.46) and (2.51)

$$K = \frac{C}{C_0} \quad (2.54)$$

Thus, the dielectric constant of a substance is the factor (>1) by which the capacitance increases from its vacuum value, when the dielectric is inserted fully between the plates of a capacitor. Though we arrived at

Eq. (2.54) for the case of a parallel plate capacitor, it holds good for any type of capacitor and can, in fact, be viewed in general as a definition of the dielectric constant of a substance.

Example 2.8 A slab of material of dielectric constant K has the same area as the plates of a parallel-plate capacitor but has a thickness $(3/4)d$, where d is the separation of the plates. How is the capacitance changed when the slab is inserted between the plates?

Solution Let $E_0 = V_0/d$ be the electric field between the plates when there is no dielectric and the potential difference is V_0 . If the dielectric is now inserted, the electric field in the dielectric will be $E = E_0/K$. The potential difference will then be

$$\begin{aligned} V &= E_0\left(\frac{1}{4}d\right) + \frac{E_0}{K}\left(\frac{3}{4}d\right) \\ &= E_0d\left(\frac{1}{4} + \frac{3}{4K}\right) = V_0 \frac{K+3}{4K} \end{aligned}$$

The potential difference decreases by the factor $(K+3)/4K$ while the free charge Q_0 on the plates remains unchanged. The capacitance thus increases

$$C = \frac{Q_0}{V} = \frac{4K}{K+3} \frac{Q_0}{V_0} = \frac{4K}{K+3} C_0$$

EXAMPLE 2.8

2.14 COMBINATION OF CAPACITORS

We can combine several capacitors of capacitance C_1, C_2, \dots, C_n to obtain a system with some effective capacitance C . The effective capacitance depends on the way the individual capacitors are combined. Two simple possibilities are discussed below.

2.14.1 Capacitors in series

Figure 2.26 shows capacitors C_1 and C_2 combined in series.

The left plate of C_1 and the right plate of C_2 are connected to two terminals of a battery and have charges Q and $-Q$, respectively. It then follows that the right plate of C_1 has charge $-Q$ and the left plate of C_2 has charge Q . If this was not so, the net charge on each capacitor would not be zero. This would result in an electric field in the conductor connecting C_1 and C_2 . Charge would flow until the net charge on both C_1 and C_2 is zero and there is no electric field in the conductor connecting C_1 and C_2 . Thus, in the series combination, charges on the two plates ($\pm Q$) are the same on each capacitor. The total

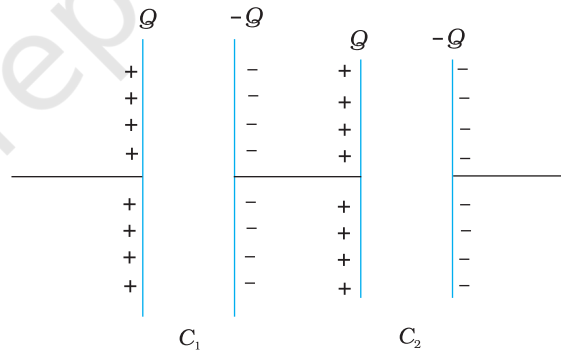

FIGURE 2.26 Combination of two capacitors in series.

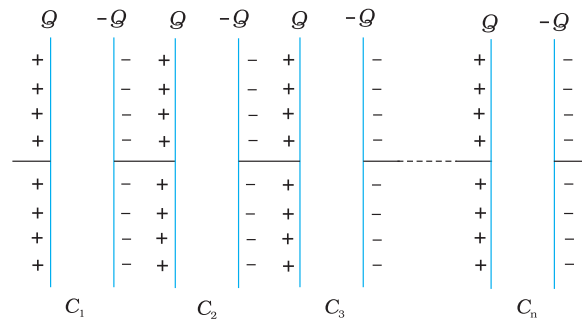

FIGURE 2.27 Combination of n capacitors in series.

potential drop V across the combination is the sum of the potential drops V_1 and V_2 across C_1 and C_2 , respectively.

$$V = V_1 + V_2 = \frac{Q}{C_1} + \frac{Q}{C_2} \quad (2.55)$$

$$\text{i.e., } \frac{V}{Q} = \frac{1}{C_1} + \frac{1}{C_2}, \quad (2.56)$$

Now we can regard the combination as an effective capacitor with charge Q and potential difference V . The *effective capacitance* of the combination is

$$C = \frac{Q}{V} \quad (2.57)$$

We compare Eq. (2.57) with Eq. (2.56), and obtain

$$\frac{1}{C} = \frac{1}{C_1} + \frac{1}{C_2} \quad (2.58)$$

The proof clearly goes through for any number of capacitors arranged in a similar way. Equation (2.55), for n capacitors arranged in series, generalises to

$$V = V_1 + V_2 + \dots + V_n = \frac{Q}{C_1} + \frac{Q}{C_2} + \dots + \frac{Q}{C_n} \quad (2.59)$$

Following the same steps as for the case of two capacitors, we get the general formula for effective capacitance of a series combination of n capacitors:

$$\frac{1}{C} = \frac{1}{C_1} + \frac{1}{C_2} + \frac{1}{C_3} + \dots + \frac{1}{C_n} \quad (2.60)$$

2.14.2 Capacitors in parallel

Figure 2.28 (a) shows two capacitors arranged in parallel. In this case, the same potential difference is applied across both the capacitors. But the plate charges ($\pm Q_1$) on capacitor 1 and the plate charges ($\pm Q_2$) on the capacitor 2 are not necessarily the same:

$$Q_1 = C_1 V, \quad Q_2 = C_2 V \quad (2.61)$$

The equivalent capacitor is one with charge

$$Q = Q_1 + Q_2 \quad (2.62)$$

and potential difference V .

$$Q = CV = C_1 V + C_2 V \quad (2.63)$$

The effective capacitance C is, from Eq. (2.63),

$$C = C_1 + C_2 \quad (2.64)$$

The general formula for effective capacitance C for parallel combination of n capacitors [Fig. 2.28 (b)] follows similarly,

$$Q = Q_1 + Q_2 + \dots + Q_n \quad (2.65)$$

$$\text{i.e., } CV = C_1 V + C_2 V + \dots + C_n V \quad (2.66)$$

which gives

$$C = C_1 + C_2 + \dots + C_n \quad (2.67)$$

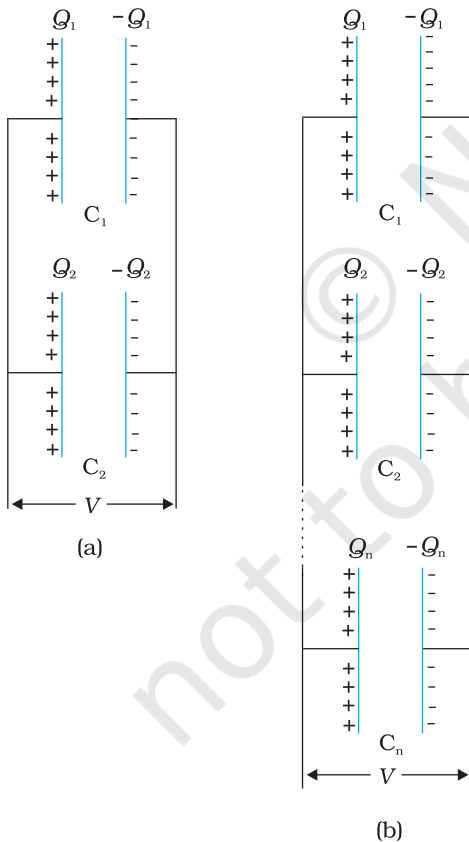

FIGURE 2.28 Parallel combination of (a) two capacitors, (b) n capacitors.

Example 2.9 A network of four $10\ \mu\text{F}$ capacitors is connected to a $500\ \text{V}$ supply, as shown in Fig. 2.29. Determine (a) the equivalent capacitance of the network and (b) the charge on each capacitor. (Note, the charge on a capacitor is the charge on the plate with higher potential, equal and opposite to the charge on the plate with lower potential.)

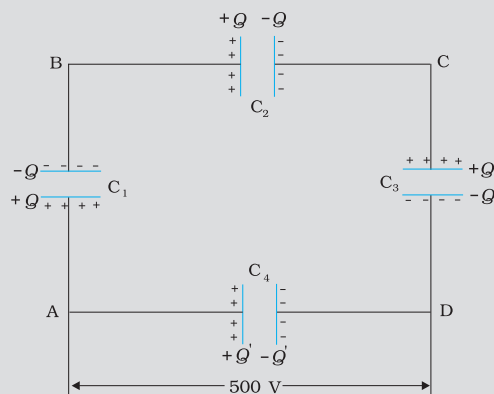

FIGURE 2.29

Solution

(a) In the given network, C_1 , C_2 and C_3 are connected in series. The effective capacitance C' of these three capacitors is given by

$$\frac{1}{C'} = \frac{1}{C_1} + \frac{1}{C_2} + \frac{1}{C_3}$$

For $C_1 = C_2 = C_3 = 10\ \mu\text{F}$, $C' = (10/3)\ \mu\text{F}$. The network has C' and C_4 connected in parallel. Thus, the equivalent capacitance C of the network is

$$C = C' + C_4 = \left(\frac{10}{3} + 10\right)\ \mu\text{F} = 13.3\ \mu\text{F}$$

(b) Clearly, from the figure, the charge on each of the capacitors, C_1 , C_2 and C_3 is the same, say Q . Let the charge on C_4 be Q' . Now, since the potential difference across AB is Q/C_1 , across BC is Q/C_2 , across CD is Q/C_3 , we have

$$\frac{Q}{C_1} + \frac{Q}{C_2} + \frac{Q}{C_3} = 500\ \text{V}$$

Also, $Q'/C_4 = 500\ \text{V}$.

This gives for the given value of the capacitances,

$$Q = 500\ \text{V} \times \frac{10}{3}\ \mu\text{F} = 1.7 \times 10^{-3}\ \text{C} \quad \text{and}$$

$$Q' = 500\ \text{V} \times 10\ \mu\text{F} = 5.0 \times 10^{-3}\ \text{C}$$

EXAMPLE 2.9

2.15 ENERGY STORED IN A CAPACITOR

A capacitor, as we have seen above, is a system of two conductors with charge Q and $-Q$. To determine the energy stored in this configuration, consider initially two uncharged conductors 1 and 2. Imagine next a process of transferring charge from conductor 2 to conductor 1 bit by

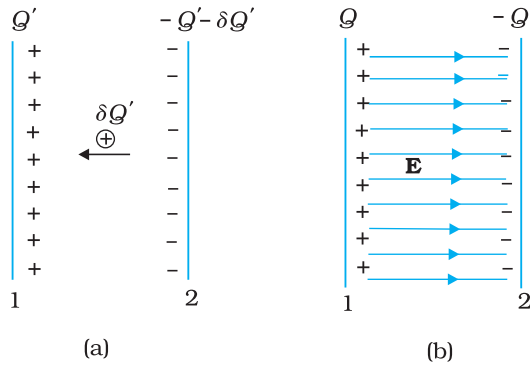

FIGURE 2.30 (a) Work done in a small step of building charge on conductor 1 from Q' to $Q' + \delta Q'$. (b) Total work done in charging the capacitor may be viewed as stored in the energy of electric field between the plates.

bit, so that at the end, conductor 1 gets charge Q . By charge conservation, conductor 2 has charge $-Q$ at the end (Fig 2.30).

In transferring positive charge from conductor 2 to conductor 1, work will be done externally, since at any stage conductor 1 is at a higher potential than conductor 2. To calculate the total work done, we first calculate the work done in a small step involving transfer of an infinitesimal (i.e., vanishingly small) amount of charge. Consider the intermediate situation when the conductors 1 and 2 have charges Q' and $-Q'$ respectively. At this stage, the potential difference V between conductors 1 to 2 is Q'/C , where C is the capacitance of the system. Next imagine that a small charge $\delta Q'$ is transferred from conductor 2 to 1. Work done in this step (δW), resulting in charge Q' on conductor 1 increasing to $Q' + \delta Q'$, is given by

$$\delta W = V' \delta Q' = \frac{Q'}{C} \delta Q' \quad (2.68)$$

Integrating eq. (2.68)

$$W = \int_0^Q \frac{Q'}{C} \delta Q' = \frac{1}{C} \frac{Q'^2}{2} \Big|_0^Q = \frac{Q^2}{2C}$$

We can write the final result, in different ways

$$W = \frac{Q^2}{2C} = \frac{1}{2} CV^2 = \frac{1}{2} QV \quad (2.69)$$

Since electrostatic force is conservative, this work is stored in the form of potential energy of the system. For the same reason, the final result for potential energy [Eq. (2.69)] is independent of the manner in which the charge configuration of the capacitor is built up. When the capacitor discharges, this stored-up energy is released. It is possible to view the potential energy of the capacitor as 'stored' in the electric field between the plates. To see this, consider for simplicity, a parallel plate capacitor [of area A (of each plate) and separation d between the plates].

Energy stored in the capacitor

$$= \frac{1}{2} \frac{Q^2}{C} = \frac{(A\sigma)^2}{2} \times \frac{d}{\epsilon_0 A} \quad (2.70)$$

The surface charge density σ is related to the electric field E between the plates,

$$E = \frac{\sigma}{\epsilon_0} \quad (2.71)$$

From Eqs. (2.70) and (2.71), we get

Energy stored in the capacitor

$$U = (1/2) \epsilon_0 E^2 \times A d \quad (2.72)$$

Note that Ad is the volume of the region between the plates (where electric field alone exists). If we define *energy density as energy stored per unit volume of space*, Eq (2.72) shows that

Energy density of electric field,

$$u = (1/2)\epsilon_0 E^2 \quad (2.73)$$

Though we derived Eq. (2.73) for the case of a parallel plate capacitor, the result on energy density of an electric field is, in fact, very general and holds true for electric field due to any configuration of charges.

Example 2.10 (a) A 900 pF capacitor is charged by 100 V battery [Fig. 2.31(a)]. How much electrostatic energy is stored by the capacitor? (b) The capacitor is disconnected from the battery and connected to another 900 pF capacitor [Fig. 2.31(b)]. What is the electrostatic energy stored by the system?

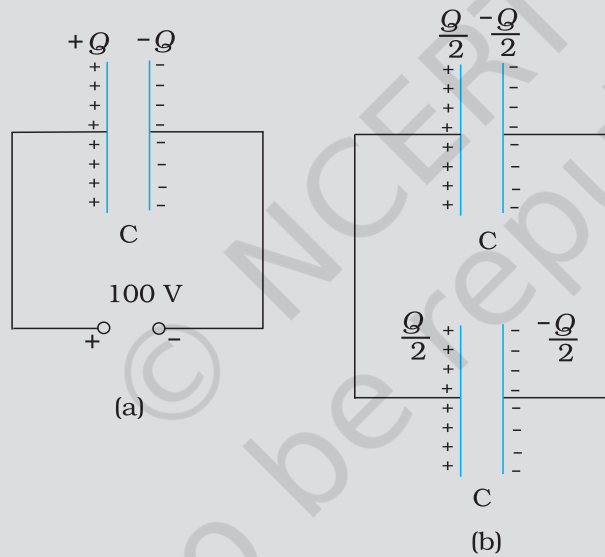

FIGURE 2.31

Solution

(a) The charge on the capacitor is

$$Q = CV = 900 \times 10^{-12} \text{ F} \times 100 \text{ V} = 9 \times 10^{-8} \text{ C}$$

The energy stored by the capacitor is

$$= (1/2) CV^2 = (1/2) QV$$

$$= (1/2) \times 9 \times 10^{-8} \text{ C} \times 100 \text{ V} = 4.5 \times 10^{-6} \text{ J}$$

(b) In the steady situation, the two capacitors have their positive plates at the same potential, and their negative plates at the same potential. Let the common potential difference be V' . The

EXAMPLE 2.10

charge on each capacitor is then $Q' = CV'$. By charge conservation, $Q' = Q/2$. This implies $V' = V/2$. The total energy of the system is

$$= 2 \times \frac{1}{2} Q' V' = \frac{1}{4} QV = 2.25 \times 10^{-6} \text{ J}$$

Thus in going from (a) to (b), though no charge is lost; the final energy is only half the initial energy. *Where has the remaining energy gone?*

There is a transient period before the system settles to the situation (b). During this period, a transient current flows from the first capacitor to the second. Energy is lost during this time in the form of heat and electromagnetic radiation.

SUMMARY

1. Electrostatic force is a conservative force. Work done by an external force (equal and opposite to the electrostatic force) in bringing a charge q from a point R to a point P is $q(V_P - V_R)$, which is the difference in potential energy of charge q between the final and initial points.
2. Potential at a point is the work done per unit charge (by an external agency) in bringing a charge from infinity to that point. Potential at a point is arbitrary to within an additive constant, since it is the potential difference between two points which is physically significant. If potential at infinity is chosen to be zero; potential at a point with position vector \mathbf{r} due to a point charge Q placed at the origin is given by

$$V(\mathbf{r}) = \frac{1}{4\pi\epsilon_0} \frac{Q}{r}$$

3. The electrostatic potential at a point with position vector \mathbf{r} due to a point dipole of dipole moment \mathbf{p} placed at the origin is

$$V(\mathbf{r}) = \frac{1}{4\pi\epsilon_0} \frac{\mathbf{p} \cdot \hat{\mathbf{r}}}{r^2}$$

The result is true also for a dipole (with charges $-q$ and q separated by $2a$) for $r \gg a$.

4. For a charge configuration q_1, q_2, \dots, q_n with position vectors $\mathbf{r}_1, \mathbf{r}_2, \dots, \mathbf{r}_n$, the potential at a point P is given by the superposition principle

$$V = \frac{1}{4\pi\epsilon_0} \left(\frac{q_1}{r_{1P}} + \frac{q_2}{r_{2P}} + \dots + \frac{q_n}{r_{nP}} \right)$$

where r_{1P} is the distance between q_1 and P, as and so on.

5. An equipotential surface is a surface over which potential has a constant value. For a point charge, concentric spheres centred at a location of the charge are equipotential surfaces. The electric field \mathbf{E} at a point is perpendicular to the equipotential surface through the point. \mathbf{E} is in the direction of the steepest decrease of potential.

6. Potential energy stored in a system of charges is the work done (by an external agency) in assembling the charges at their locations. Potential energy of two charges q_1, q_2 at $\mathbf{r}_1, \mathbf{r}_2$ is given by

$$U = \frac{1}{4\pi\epsilon_0} \frac{q_1 q_2}{r_{12}}$$

where r_{12} is distance between q_1 and q_2 .

7. The potential energy of a charge q in an external potential $V(\mathbf{r})$ is $qV(\mathbf{r})$. The potential energy of a dipole moment \mathbf{p} in a uniform electric field \mathbf{E} is $-\mathbf{p}\cdot\mathbf{E}$.
8. Electrostatics field \mathbf{E} is zero in the interior of a conductor; just outside the surface of a charged conductor, \mathbf{E} is normal to the surface given by

$\mathbf{E} = \frac{\sigma}{\epsilon_0} \hat{\mathbf{n}}$ where $\hat{\mathbf{n}}$ is the unit vector along the outward normal to the surface and σ is the surface charge density. Charges in a conductor can reside only at its surface. Potential is constant within and on the surface of a conductor. In a cavity within a conductor (with no charges), the electric field is zero.

9. A capacitor is a system of two conductors separated by an insulator. Its capacitance is defined by $C = Q/V$, where Q and $-Q$ are the charges on the two conductors and V is the potential difference between them. C is determined purely geometrically, by the shapes, sizes and relative positions of the two conductors. The unit of capacitance is farad; $1 \text{ F} = 1 \text{ C V}^{-1}$. For a parallel plate capacitor (with vacuum between the plates),

$$C = \epsilon_0 \frac{A}{d}$$

where A is the area of each plate and d the separation between them.

10. If the medium between the plates of a capacitor is filled with an insulating substance (dielectric), the electric field due to the charged plates induces a net dipole moment in the dielectric. This effect, called polarisation, gives rise to a field in the opposite direction. The net electric field inside the dielectric and hence the potential difference between the plates is thus reduced. Consequently, the capacitance C increases from its value C_0 when there is no medium (vacuum),

$$C = KC_0$$

where K is the dielectric constant of the insulating substance.

11. For capacitors in the series combination, the total capacitance C is given by

$$\frac{1}{C} = \frac{1}{C_1} + \frac{1}{C_2} + \frac{1}{C_3} + \dots$$

In the parallel combination, the total capacitance C is:

$$C = C_1 + C_2 + C_3 + \dots$$

where C_1, C_2, C_3, \dots are individual capacitances.

12. The energy U stored in a capacitor of capacitance C , with charge Q and voltage V is

$$U = \frac{1}{2} QV = \frac{1}{2} CV^2 = \frac{1}{2} \frac{Q^2}{C}$$

The electric energy density (energy per unit volume) in a region with electric field is $(1/2)\epsilon_0 E^2$.

Physical quantity	Symbol	Dimensions	Unit	Remark
Potential	ϕ or V	$[M^1 L^2 T^{-3} A^{-1}]$	V	Potential difference is physically significant
Capacitance	C	$[M^{-1} L^{-2} T^4 A^2]$	F	Dipole moment per unit volume
Polarisation	\mathbf{P}	$[L^{-2} AT]$	$C\ m^{-2}$	
Dielectric constant	K	[Dimensionless]		

POINTS TO PONDER

1. Electrostatics deals with forces between charges at rest. But if there is a force on a charge, how can it be at rest? Thus, when we are talking of electrostatic force between charges, it should be understood that each charge is being kept at rest by some unspecified force that opposes the net Coulomb force on the charge.
2. A capacitor is so configured that it confines the electric field lines within a small region of space. Thus, even though field may have considerable strength, the potential difference between the two conductors of a capacitor is small.
3. Electric field is discontinuous across the surface of a spherical charged shell. It is zero inside and $\frac{\sigma}{\epsilon_0} \hat{n}$ outside. Electric potential is, however continuous across the surface, equal to $q/4\pi\epsilon_0 R$ at the surface.
4. The torque $\mathbf{p} \times \mathbf{E}$ on a dipole causes it to oscillate about \mathbf{E} . Only if there is a dissipative mechanism, the oscillations are damped and the dipole eventually aligns with \mathbf{E} .
5. Potential due to a charge q at its own location is not defined – it is infinite.
6. In the expression $qV(\mathbf{r})$ for potential energy of a charge q , $V(\mathbf{r})$ is the potential due to external charges and not the potential due to q . As seen in point 5, this expression will be ill-defined if $V(\mathbf{r})$ includes potential due to a charge q itself.

7. A cavity inside a conductor is shielded from outside electrical influences. It is worth noting that electrostatic shielding does not work the other way round; that is, if you put charges inside the cavity, the exterior of the conductor is not shielded from the fields by the inside charges.

EXERCISES

- 2.1** Two charges $5 \times 10^{-8} \text{ C}$ and $-3 \times 10^{-8} \text{ C}$ are located 16 cm apart. At what point(s) on the line joining the two charges is the electric potential zero? Take the potential at infinity to be zero.
- 2.2** A regular hexagon of side 10 cm has a charge $5 \mu\text{C}$ at each of its vertices. Calculate the potential at the centre of the hexagon.
- 2.3** Two charges $2 \mu\text{C}$ and $-2 \mu\text{C}$ are placed at points A and B 6 cm apart.
- Identify an equipotential surface of the system.
 - What is the direction of the electric field at every point on this surface?
- 2.4** A spherical conductor of radius 12 cm has a charge of $1.6 \times 10^{-7} \text{ C}$ distributed uniformly on its surface. What is the electric field
- inside the sphere
 - just outside the sphere
 - at a point 18 cm from the centre of the sphere?
- 2.5** A parallel plate capacitor with air between the plates has a capacitance of 8 pF ($1 \text{ pF} = 10^{-12} \text{ F}$). What will be the capacitance if the distance between the plates is reduced by half, and the space between them is filled with a substance of dielectric constant 6?
- 2.6** Three capacitors each of capacitance 9 pF are connected in series.
- What is the total capacitance of the combination?
 - What is the potential difference across each capacitor if the combination is connected to a 120 V supply?
- 2.7** Three capacitors of capacitances 2 pF, 3 pF and 4 pF are connected in parallel.
- What is the total capacitance of the combination?
 - Determine the charge on each capacitor if the combination is connected to a 100 V supply.
- 2.8** In a parallel plate capacitor with air between the plates, each plate has an area of $6 \times 10^{-3} \text{ m}^2$ and the distance between the plates is 3 mm. Calculate the capacitance of the capacitor. If this capacitor is connected to a 100 V supply, what is the charge on each plate of the capacitor?

- 2.9** Explain what would happen if in the capacitor given in Exercise 2.8, a 3 mm thick mica sheet (of dielectric constant = 6) were inserted between the plates,
- while the voltage supply remained connected.
 - after the supply was disconnected.
- 2.10** A 12pF capacitor is connected to a 50V battery. How much electrostatic energy is stored in the capacitor?
- 2.11** A 600pF capacitor is charged by a 200V supply. It is then disconnected from the supply and is connected to another uncharged 600 pF capacitor. How much electrostatic energy is lost in the process?

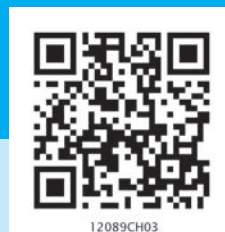

Chapter Three

CURRENT ELECTRICITY



3.1 INTRODUCTION

In Chapter 1, all charges whether free or bound, were considered to be at rest. Charges in motion constitute an electric current. Such currents occur naturally in many situations. Lightning is one such phenomenon in which charges flow from the clouds to the earth through the atmosphere, sometimes with disastrous results. The flow of charges in lightning is not steady, but in our everyday life we see many devices where charges flow in a steady manner, like water flowing smoothly in a river. A torch and a cell-driven clock are examples of such devices. In the present chapter, we shall study some of the basic laws concerning steady electric currents.

3.2 ELECTRIC CURRENT

Imagine a small area held normal to the direction of flow of charges. Both the positive and the negative charges may flow forward and backward across the area. In a given time interval t , let q_+ be the net amount (*i.e.*, forward *minus* backward) of positive charge that flows in the forward direction across the area. Similarly, let q_- be the net amount of negative charge flowing across the area in the forward direction. The net amount of charge flowing across the area in the forward direction in the time interval t , then, is $q = q_+ - q_-$. This is proportional to t for steady current

and the quotient

$$I = \frac{q}{t} \quad (3.1)$$

is defined to be the *current* across the area in the forward direction. (If it turn out to be a negative number, it implies a current in the backward direction.)

Currents are not always steady and hence more generally, we define the current as follows. Let ΔQ be the net charge flowing across a cross-section of a conductor during the time interval Δt [i.e., between times t and $(t + \Delta t)$]. Then, the current at time t across the cross-section of the conductor is defined as the value of the ratio of ΔQ to Δt in the limit of Δt tending to zero,

$$I(t) \equiv \lim_{\Delta t \rightarrow 0} \frac{\Delta Q}{\Delta t} \quad (3.2)$$

In SI units, the unit of current is ampere. An ampere is defined through magnetic effects of currents that we will study in the following chapter. An ampere is typically the order of magnitude of currents in domestic appliances. An average lightning carries currents of the order of tens of thousands of amperes and at the other extreme, currents in our nerves are in microamperes.

3.3 ELECTRIC CURRENTS IN CONDUCTORS

An electric charge will experience a force if an electric field is applied. If it is free to move, it will thus move contributing to a current. In nature, free charged particles do exist like in upper strata of atmosphere called the *ionosphere*. However, in atoms and molecules, the negatively charged electrons and the positively charged nuclei are bound to each other and are thus not free to move. Bulk matter is made up of many molecules, a gram of water, for example, contains approximately 10^{22} molecules. These molecules are so closely packed that the electrons are no longer attached to individual nuclei. In some materials, the electrons will still be bound, i.e., they will not accelerate even if an electric field is applied. In other materials, notably metals, some of the electrons are practically free to move within the bulk material. These materials, generally called conductors, develop electric currents in them when an electric field is applied.

If we consider solid conductors, then of course the atoms are tightly bound to each other so that the current is carried by the negatively charged electrons. There are, however, other types of conductors like electrolytic solutions where positive and negative charges both can move. In our discussions, we will focus only on solid conductors so that the current is carried by the negatively charged electrons in the background of fixed positive ions.

Consider first the case when no electric field is present. The electrons will be moving due to thermal motion during which they collide with the fixed ions. An electron colliding with an ion emerges with the same speed as before the collision. However, the direction of its velocity after the collision is completely random. At a given time, there is no preferential direction for the velocities of the electrons. Thus on the average, the

number of electrons travelling in any direction will be equal to the number of electrons travelling in the opposite direction. So, there will be no net electric current.

Let us now see what happens to such a piece of conductor if an electric field is applied. To focus our thoughts, imagine the conductor in the shape of a cylinder of radius R (Fig. 3.1). Suppose we now take two thin circular discs of a dielectric of the same radius and put positive charge $+Q$ distributed over one disc and similarly $-Q$ at the other disc. We attach the two discs on the two flat surfaces of the cylinder. An electric field will be created and is directed from the positive towards the negative charge. The electrons will be accelerated due to this field towards $+Q$. They will thus move to neutralise the charges. The electrons, as long as they are moving, will constitute an electric current. Hence in the situation considered, there will be a current for a very short while and no current thereafter.

We can also imagine a mechanism where the ends of the cylinder are supplied with fresh charges to make up for any charges neutralised by electrons moving inside the conductor. In that case, there will be a steady electric field in the body of the conductor. This will result in a continuous current rather than a current for a short period of time. Mechanisms, which maintain a steady electric field are cells or batteries that we shall study later in this chapter. In the next sections, we shall study the steady current that results from a steady electric field in conductors.



FIGURE 3.1 Charges $+Q$ and $-Q$ put at the ends of a metallic cylinder. The electrons will drift because of the electric field created to neutralise the charges. The current thus will stop after a while unless the charges $+Q$ and $-Q$ are continuously replenished.

3.4 OHM'S LAW

A basic law regarding flow of currents was discovered by G.S. Ohm in 1828, long before the physical mechanism responsible for flow of currents was discovered. Imagine a conductor through which a current I is flowing and let V be the potential difference between the ends of the conductor. Then Ohm's law states that

$$V \propto I$$

$$\text{or, } V = RI \tag{3.3}$$

where the constant of proportionality R is called the *resistance* of the conductor. The SI units of resistance is *ohm*, and is denoted by the symbol Ω . The resistance R not only depends on the material of the conductor but also on the dimensions of the conductor. The dependence of R on the dimensions of the conductor can easily be determined as follows.

Consider a conductor satisfying Eq. (3.3) to be in the form of a slab of length l and cross sectional area A [Fig. 3.2(a)]. Imagine placing two such identical slabs side by side [Fig. 3.2(b)], so that the length of the combination is $2l$. The current flowing through the combination is the same as that flowing through either of the slabs. If V is the potential difference across the ends of the first slab, then V is also the potential difference across the ends of the second slab since the second slab is

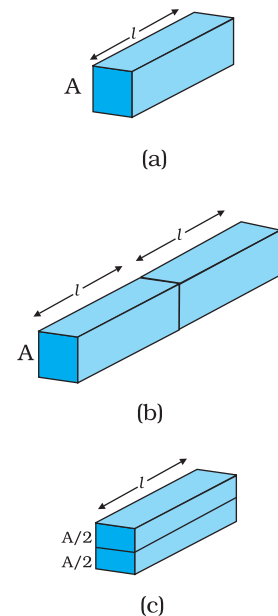

FIGURE 3.2 Illustrating the relation $R = \rho l/A$ for a rectangular slab of length l and area of cross-section A .



Georg Simon Ohm (1787–1854) German physicist, professor at Munich. Ohm was led to his law by an analogy between the conduction of heat: the electric field is analogous to the temperature gradient, and the electric current is analogous to the heat flow.

identical to the first and the same current I flows through both. The potential difference across the ends of the combination is clearly sum of the potential difference across the two individual slabs and hence equals $2V$. The current through the combination is I and the resistance of the combination R_c is [from Eq. (3.3)],

$$R_c = \frac{2V}{I} = 2R \quad (3.4)$$

since $V/I = R$, the resistance of either of the slabs. Thus, doubling the length of a conductor doubles the resistance. In general, then resistance is proportional to length,

$$R \propto l \quad (3.5)$$

Next, imagine dividing the slab into two by cutting it lengthwise so that the slab can be considered as a combination of two identical slabs of length l , but each having a cross sectional area of $A/2$ [Fig. 3.2(c)].

For a given voltage V across the slab, if I is the current through the entire slab, then clearly the current flowing through each of the two half-slabs is $I/2$. Since the potential difference across the ends of the half-slabs is V , i.e., the same as across the full slab, the resistance of each of the half-slabs R_1 is

$$R_1 = \frac{V}{(I/2)} = 2 \frac{V}{I} = 2R. \quad (3.6)$$

Thus, halving the area of the cross-section of a conductor doubles the resistance. In general, then the resistance R is inversely proportional to the cross-sectional area,

$$R \propto \frac{1}{A} \quad (3.7)$$

Combining Eqs. (3.5) and (3.7), we have

$$R \propto \frac{l}{A} \quad (3.8)$$

and hence for a given conductor

$$R = \rho \frac{l}{A} \quad (3.9)$$

where the constant of proportionality ρ depends on the material of the conductor but not on its dimensions. ρ is called *resistivity*.

Using the last equation, Ohm's law reads

$$V = I \times R = \frac{I\rho l}{A} \quad (3.10)$$

Current per unit area (taken normal to the current), I/A , is called *current density* and is denoted by j . The SI units of the current density are A/m^2 . Further, if E is the magnitude of uniform electric field in the conductor whose length is l , then the potential difference V across its ends is El . Using these, the last equation reads

$$E l = j \rho l$$

$$\text{or, } E = j \rho \quad (3.11)$$

The above relation for **magnitudes** E and j can indeed be cast in a **vector** form. The current density, (which we have defined as the current through unit area **normal** to the current) is also directed along \mathbf{E} , and is also a vector \mathbf{j} ($\equiv j \mathbf{E}/E$). Thus, the last equation can be written as,

$$\mathbf{E} = j \rho \quad (3.12)$$

$$\text{or, } \mathbf{j} = \sigma \mathbf{E} \quad (3.13)$$

where $\sigma \equiv 1/\rho$ is called the *conductivity*. Ohm's law is often stated in an equivalent form, Eq. (3.13) in addition to Eq.(3.3). In the next section, we will try to understand the origin of the Ohm's law as arising from the characteristics of the drift of electrons.

3.5 DRIFT OF ELECTRONS AND THE ORIGIN OF RESISTIVITY

As remarked before, an electron will suffer collisions with the heavy fixed ions, but after collision, it will emerge with the same speed but in random directions. If we consider all the electrons, their average velocity will be zero since their directions are random. Thus, if there are N electrons and the velocity of the i^{th} electron ($i = 1, 2, 3, \dots, N$) at a given time is \mathbf{v}_i , then

$$\frac{1}{N} \sum_{i=1}^N \mathbf{v}_i = 0 \quad (3.14)$$

Consider now the situation when an electric field is present. Electrons will be accelerated due to this field by

$$\mathbf{a} = \frac{-e\mathbf{E}}{m} \quad (3.15)$$

where $-e$ is the charge and m is the mass of an electron. Consider again the i^{th} electron at a given time t . This electron would have had its last collision some time before t , and let t_i be the time elapsed after its last collision. If \mathbf{v}_i was its velocity immediately after the last collision, then its velocity \mathbf{V}_i at time t is

$$\mathbf{V}_i = \mathbf{v}_i + \frac{-e\mathbf{E}}{m} t_i \quad (3.16)$$

since starting with its last collision it was accelerated (Fig. 3.3) with an acceleration given by Eq. (3.15) for a time interval t_i . The average velocity of the electrons at time t is the average of all the \mathbf{V}_i 's. The average of \mathbf{v}_i 's is zero [Eq. (3.14)] since immediately after any collision, the direction of the velocity of an electron is completely random. The collisions of the electrons do not occur at regular intervals but at random times. Let us denote by τ , the average time between successive collisions. Then at a given time, some of the electrons would have spent

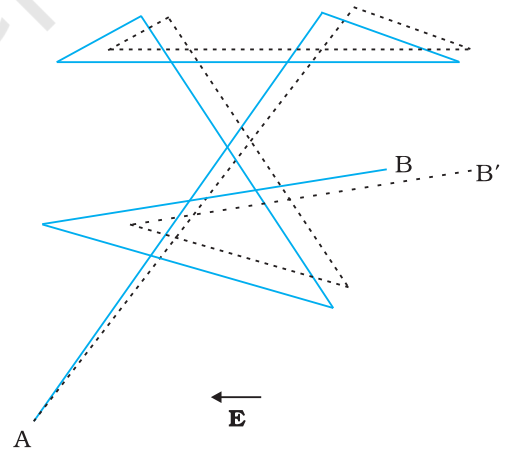

FIGURE 3.3 A schematic picture of an electron moving from a point A to another point B through repeated collisions, and straight line travel between collisions (full lines). If an electric field is applied as shown, the electron ends up at point B' (dotted lines). A slight drift in a direction opposite the electric field is visible.

time more than τ and some less than τ . In other words, the time t_i in Eq. (3.16) will be less than τ for some and more than τ for others as we go through the values of $i = 1, 2, \dots, N$. The average value of t_i then is τ (known as *relaxation time*). Thus, averaging Eq. (3.16) over the N -electrons at any given time t gives us for the average velocity \mathbf{v}_d

$$\begin{aligned} \mathbf{v}_d &\equiv (\mathbf{v}_i)_{\text{average}} = (\mathbf{v}_i)_{\text{average}} - \frac{e\mathbf{E}}{m} (t_i)_{\text{average}} \\ &= 0 - \frac{e\mathbf{E}}{m} \tau = -\frac{e\mathbf{E}}{m} \tau \end{aligned} \quad (3.17)$$

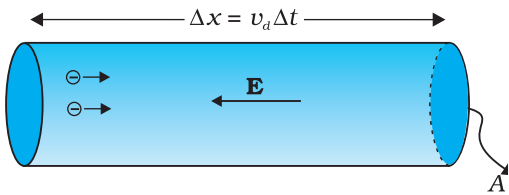

FIGURE 3.4 Current in a metallic conductor. The magnitude of current density in a metal is the magnitude of charge contained in a cylinder of unit area and length v_d .

This last result is surprising. It tells us that the electrons move with an average velocity which is independent of time, although electrons are accelerated. This is the phenomenon of drift and the velocity \mathbf{v}_d in Eq. (3.17) is called the **drift velocity**.

Because of the drift, there will be net transport of charges across any area perpendicular to \mathbf{E} . Consider a planar area A , located inside the conductor such that the normal to the area is parallel to \mathbf{E} (Fig. 3.4). Then because of the drift, in an infinitesimal amount of time Δt , all electrons to the left of the area at distances upto $|\mathbf{v}_d| \Delta t$ would have crossed the area. If n is the number of free electrons per unit volume in the metal, then there are $n \Delta t |\mathbf{v}_d| A$ such electrons. Since each

electron carries a charge $-e$, the total charge transported across this area A to the right in time Δt is $-ne A |\mathbf{v}_d| \Delta t$. \mathbf{E} is directed towards the left and hence the total charge transported along \mathbf{E} across the area is negative of this. The amount of charge crossing the area A in time Δt is by definition [Eq. (3.2)] $I \Delta t$, where I is the magnitude of the current. Hence,

$$I \Delta t = +n e A |\mathbf{v}_d| \Delta t \quad (3.18)$$

Substituting the value of $|\mathbf{v}_d|$ from Eq. (3.17)

$$I \Delta t = \frac{e^2 A}{m} \tau n \Delta t |\mathbf{E}| \quad (3.19)$$

By definition I is related to the magnitude $|j|$ of the current density by

$$I = |j| A \quad (3.20)$$

Hence, from Eqs.(3.19) and (3.20),

$$|j| = \frac{ne^2}{m} \tau |\mathbf{E}| \quad (3.21)$$

The vector \mathbf{j} is parallel to \mathbf{E} and hence we can write Eq. (3.21) in the vector form

$$\mathbf{j} = \frac{ne^2}{m} \tau \mathbf{E} \quad (3.22)$$

Comparison with Eq. (3.13) shows that Eq. (3.22) is exactly the Ohm's law, if we identify the conductivity σ as

$$\sigma = \frac{ne^2}{m} \tau \quad (3.23)$$

We thus see that a very simple picture of electrical conduction reproduces Ohm's law. We have, of course, made assumptions that τ and n are constants, independent of E . We shall, in the next section, discuss the limitations of Ohm's law.

Example 3.1 (a) Estimate the average drift speed of conduction electrons in a copper wire of cross-sectional area $1.0 \times 10^{-7} \text{ m}^2$ carrying a current of 1.5 A. Assume that each copper atom contributes roughly one conduction electron. The density of copper is $9.0 \times 10^3 \text{ kg/m}^3$, and its atomic mass is 63.5 u. (b) Compare the drift speed obtained above with, (i) thermal speeds of copper atoms at ordinary temperatures, (ii) speed of propagation of electric field along the conductor which causes the drift motion.

Solution

(a) The direction of drift velocity of conduction electrons is opposite to the electric field direction, i.e., electrons drift in the direction of increasing potential. The drift speed v_d is given by Eq. (3.18)

$$v_d = (I/neA)$$

Now, $e = 1.6 \times 10^{-19} \text{ C}$, $A = 1.0 \times 10^{-7} \text{ m}^2$, $I = 1.5 \text{ A}$. The density of conduction electrons, n is equal to the number of atoms per cubic metre (assuming one conduction electron per Cu atom as is reasonable from its valence electron count of one). A cubic metre of copper has a mass of $9.0 \times 10^3 \text{ kg}$. Since 6.0×10^{23} copper atoms have a mass of 63.5 g,

$$\begin{aligned} n &= \frac{6.0 \times 10^{23}}{63.5} \times 9.0 \times 10^6 \\ &= 8.5 \times 10^{28} \text{ m}^{-3} \end{aligned}$$

which gives,

$$\begin{aligned} v_d &= \frac{1.5}{8.5 \times 10^{28} \times 1.6 \times 10^{-19} \times 1.0 \times 10^{-7}} \\ &= 1.1 \times 10^{-3} \text{ m s}^{-1} = 1.1 \text{ mm s}^{-1} \end{aligned}$$

(b) (i) At a temperature T , the thermal speed* of a copper atom of mass M is obtained from [$\langle (1/2) Mv^2 \rangle = (3/2) k_B T$] and is thus typically of the order of $\sqrt{k_B T/M}$, where k_B is the Boltzmann constant. For copper at 300 K, this is about $2 \times 10^2 \text{ m/s}$. This figure indicates the random vibrational speeds of copper atoms in a conductor. Note that the drift speed of electrons is much smaller, about 10^{-5} times the typical thermal speed at ordinary temperatures.

(ii) An electric field travelling along the conductor has a speed of an electromagnetic wave, namely equal to $3.0 \times 10^8 \text{ m s}^{-1}$ (You will learn about this in Chapter 8). The drift speed is, in comparison, extremely small; smaller by a factor of 10^{-11} .

* See Eq. (12.23) of Chapter 12 from Class XI book.

Example 3.2

- (a) In Example 3.1, the electron drift speed is estimated to be only a few mm s^{-1} for currents in the range of a few amperes? How then is current established almost the instant a circuit is closed?
- (b) The electron drift arises due to the force experienced by electrons in the electric field inside the conductor. But force should cause acceleration. Why then do the electrons acquire a steady average drift speed?
- (c) If the electron drift speed is so small, and the electron's charge is small, how can we still obtain large amounts of current in a conductor?
- (d) When electrons drift in a metal from lower to higher potential, does it mean that all the 'free' electrons of the metal are moving in the same direction?
- (e) Are the paths of electrons straight lines between successive collisions (with the positive ions of the metal) in the (i) absence of electric field, (ii) presence of electric field?

Solution

- (a) Electric field is established throughout the circuit, almost instantly (with the speed of light) causing at every point a *local electron drift*. Establishment of a current does not have to wait for electrons from one end of the conductor travelling to the other end. However, it does take a little while for the current to reach its steady value.
- (b) Each 'free' electron does accelerate, increasing its drift speed until it collides with a positive ion of the metal. It loses its drift speed after collision but starts to accelerate and increases its drift speed again only to suffer a collision again and so on. On the average, therefore, electrons acquire only a drift speed.
- (c) Simple, because the electron number density is enormous, $\sim 10^{29} \text{ m}^{-3}$.
- (d) By no means. The drift velocity is superposed over the large random velocities of electrons.
- (e) In the absence of electric field, the paths are straight lines; in the presence of electric field, the paths are, in general, curved.

3.5.1 Mobility

As we have seen, conductivity arises from mobile charge carriers. In metals, these mobile charge carriers are electrons; in an ionised gas, they are electrons and positive charged ions; in an electrolyte, these can be both positive and negative ions.

An important quantity is the *mobility* μ defined as the magnitude of the drift velocity per unit electric field:

$$\mu = \frac{|\mathbf{v}_d|}{E} \tag{3.24}$$

The SI unit of mobility is m^2/Vs and is 10^4 of the mobility in practical units (cm^2/Vs). Mobility is positive. From Eq. (3.17), we have

$$v_d = \frac{e\tau E}{m}$$

Hence,

$$\mu = \frac{v_d}{E} = \frac{e\tau}{m} \quad (3.25)$$

where τ is the average collision time for electrons.

3.6 LIMITATIONS OF OHM'S LAW

Although Ohm's law has been found valid over a large class of materials, there do exist materials and devices used in electric circuits where the proportionality of V and I does not hold. The deviations broadly are one or more of the following types:

- V ceases to be proportional to I (Fig. 3.5).
- The relation between V and I depends on the sign of V . In other words, if I is the current for a certain V , then reversing the direction of V keeping its magnitude fixed, does not produce a current of the same magnitude as I in the opposite direction (Fig. 3.6). This happens, for example, in a diode which we will study in Chapter 14.

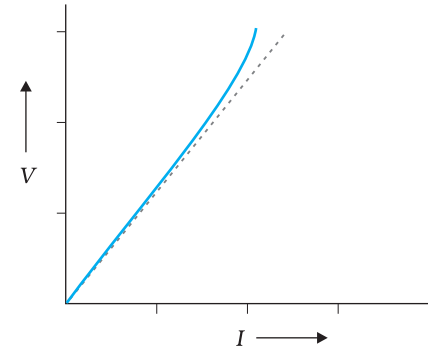

FIGURE 3.5 The dashed line represents the linear Ohm's law. The solid line is the voltage V versus current I for a good conductor.

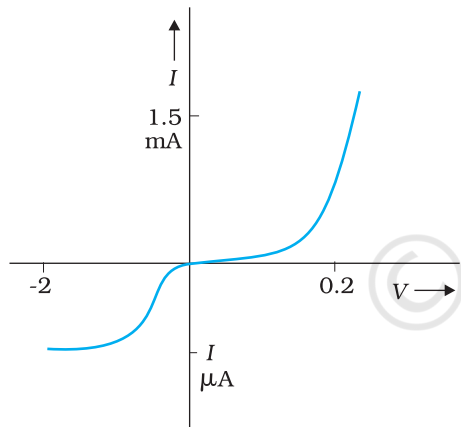

FIGURE 3.6 Characteristic curve of a diode. Note the different scales for negative and positive values of the voltage and current.

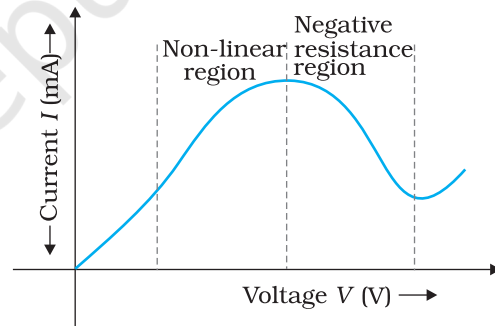

FIGURE 3.7 Variation of current versus voltage for GaAs.

- The relation between V and I is not unique, i.e., there is more than one value of V for the same current I (Fig. 3.7). A material exhibiting such behaviour is GaAs.

Materials and devices not obeying Ohm's law in the form of Eq. (3.3) are actually widely used in electronic circuits. In this and a few subsequent chapters, however, we will study the electrical currents in materials that obey Ohm's law.

3.7 RESISTIVITY OF VARIOUS MATERIALS

The materials are classified as conductors, semiconductors and insulators depending on their resistivities, in an increasing order of their values.

Metals have low resistivities in the range of $10^{-8} \Omega\text{m}$ to $10^{-6} \Omega\text{m}$. At the other end are insulators like ceramic, rubber and plastics having resistivities 10^{18} times greater than metals or more. In between the two are the semiconductors. These, however, have resistivities characteristically decreasing with a rise in temperature. The resistivities of semiconductors can be decreased by adding small amount of suitable impurities. This last feature is exploited in use of semiconductors for electronic devices.

3.8 TEMPERATURE DEPENDENCE OF RESISTIVITY

The resistivity of a material is found to be dependent on the temperature. Different materials do not exhibit the same dependence on temperatures. Over a limited range of temperatures, that is not too large, the resistivity of a metallic conductor is approximately given by,

$$\rho_T = \rho_0 [1 + \alpha (T - T_0)] \quad (3.26)$$

where ρ_T is the resistivity at a temperature T and ρ_0 is the same at a reference temperature T_0 . α is called the *temperature co-efficient of resistivity*, and from Eq. (3.26), the dimension of α is (Temperature) $^{-1}$. For metals, α is positive.

The relation of Eq. (3.26) implies that a graph of ρ_T plotted against T would be a straight line. At temperatures much lower than 0°C , the graph, however, deviates considerably from a straight line (Fig. 3.8).

Equation (3.26) thus, can be used approximately over a limited range of T around any reference temperature T_0 , where the graph can be approximated as a straight line.

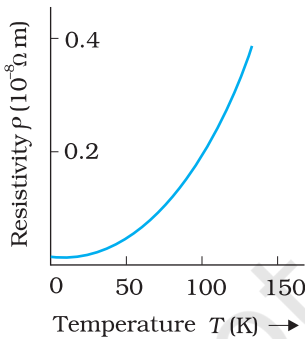

FIGURE 3.8
Resistivity ρ_T of copper as a function of temperature T .

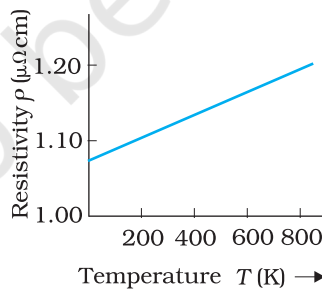

FIGURE 3.9 Resistivity ρ_T of nichrome as a function of absolute temperature T .

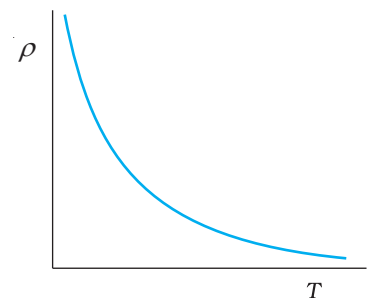

FIGURE 3.10
Temperature dependence of resistivity for a typical semiconductor.

Some materials like Nichrome (which is an alloy of nickel, iron and chromium) exhibit a very weak dependence of resistivity with temperature (Fig. 3.9). Manganin and constantan have similar properties. These materials are thus widely used in wire bound standard resistors since their resistance values would change very little with temperatures.

Unlike metals, the resistivities of semiconductors decrease with increasing temperatures. A typical dependence is shown in Fig. 3.10.

We can qualitatively understand the temperature dependence of resistivity, in the light of our derivation of Eq. (3.23). From this equation, resistivity of a material is given by

$$\rho = \frac{1}{\sigma} = \frac{m}{n e^2 \tau} \quad (3.27)$$

ρ thus depends inversely both on the number n of free electrons per unit volume and on the average time τ between collisions. As we increase temperature, average speed of the electrons, which act as the carriers of current, increases resulting in more frequent collisions. The average time of collisions τ , thus decreases with temperature.

In a metal, n is not dependent on temperature to any appreciable extent and thus the decrease in the value of τ with rise in temperature causes ρ to increase as we have observed.

For insulators and semiconductors, however, n increases with temperature. This increase more than compensates any decrease in τ in Eq.(3.23) so that for such materials, ρ decreases with temperature.

Example 3.3 An electric toaster uses nichrome for its heating element. When a negligibly small current passes through it, its resistance at room temperature (27.0 °C) is found to be 75.3 Ω. When the toaster is connected to a 230 V supply, the current settles, after a few seconds, to a steady value of 2.68 A. What is the steady temperature of the nichrome element? The temperature coefficient of resistance of nichrome averaged over the temperature range involved, is $1.70 \times 10^{-4} \text{ }^\circ\text{C}^{-1}$.

Solution When the current through the element is very small, heating effects can be ignored and the temperature T_1 of the element is the same as room temperature. When the toaster is connected to the supply, its initial current will be slightly higher than its steady value of 2.68 A. But due to heating effect of the current, the temperature will rise. This will cause an increase in resistance and a slight decrease in current. In a few seconds, a steady state will be reached when temperature will rise no further, and both the resistance of the element and the current drawn will achieve steady values. The resistance R_2 at the steady temperature T_2 is

$$R_2 = \frac{230 \text{ V}}{2.68 \text{ A}} = 85.8 \text{ } \Omega$$

Using the relation

$$R_2 = R_1 [1 + \alpha (T_2 - T_1)]$$

with $\alpha = 1.70 \times 10^{-4} \text{ }^\circ\text{C}^{-1}$, we get

$$T_2 - T_1 = \frac{(85.8 - 75.3)}{(75.3) \times 1.70 \times 10^{-4}} = 820 \text{ }^\circ\text{C}$$

that is, $T_2 = (820 + 27.0) \text{ }^\circ\text{C} = 847 \text{ }^\circ\text{C}$

Thus, the steady temperature of the heating element (when heating effect due to the current equals heat loss to the surroundings) is 847 °C.

Example 3.4 The resistance of the platinum wire of a platinum resistance thermometer at the ice point is 5Ω and at steam point is 5.23Ω . When the thermometer is inserted in a hot bath, the resistance of the platinum wire is 5.795Ω . Calculate the temperature of the bath.

Solution $R_0 = 5 \Omega$, $R_{100} = 5.23 \Omega$ and $R_t = 5.795 \Omega$

$$\begin{aligned} \text{Now, } t &= \frac{R_t - R_0}{R_{100} - R_0} \times 100, & R_t &= R_0 (1 + \alpha t) \\ &= \frac{5.795 - 5}{5.23 - 5} \times 100 \\ &= \frac{0.795}{0.23} \times 100 = 345.65 \text{ }^\circ\text{C} \end{aligned}$$

3.9 ELECTRICAL ENERGY, POWER

Consider a conductor with end points A and B, in which a current I is flowing from A to B. The electric potential at A and B are denoted by $V(A)$ and $V(B)$ respectively. Since current is flowing from A to B, $V(A) > V(B)$ and the potential difference across AB is $V = V(A) - V(B) > 0$.

In a time interval Δt , an amount of charge $\Delta Q = I \Delta t$ travels from A to B. The potential energy of the charge at A, by definition, was $Q V(A)$ and similarly at B, it is $Q V(B)$. Thus, change in its potential energy ΔU_{pot} is

$$\begin{aligned} \Delta U_{\text{pot}} &= \text{Final potential energy} - \text{Initial potential energy} \\ &= \Delta Q [V(B) - V(A)] = -\Delta Q V \\ &= -I V \Delta t < 0 \end{aligned} \tag{3.28}$$

If charges moved without collisions through the conductor, their kinetic energy would also change so that the total energy is unchanged. Conservation of total energy would then imply that,

$$\Delta K = -\Delta U_{\text{pot}} \tag{3.29}$$

that is,

$$\Delta K = I V \Delta t > 0 \tag{3.30}$$

Thus, in case charges were moving freely through the conductor under the action of electric field, their kinetic energy would increase as they move. We have, however, seen earlier that on the average, charge carriers do not move with acceleration but with a steady drift velocity. This is because of the collisions with ions and atoms during transit. During collisions, the energy gained by the charges thus is shared with the atoms. The atoms vibrate more vigorously, i.e., the conductor heats up. Thus, in an actual conductor, an amount of energy dissipated as heat in the conductor during the time interval Δt is,

$$\Delta W = I V \Delta t \tag{3.31}$$

The energy dissipated per unit time is the power dissipated $P = \Delta W / \Delta t$ and we have,

$$P = I V \tag{3.32}$$

Using Ohm's law $V = IR$, we get

$$P = I^2 R = V^2/R \quad (3.33)$$

as the power loss ("ohmic loss") in a conductor of resistance R carrying a current I . It is this power which heats up, for example, the coil of an electric bulb to incandescence, radiating out heat and light.

Where does the power come from? As we have reasoned before, we need an external source to keep a steady current through the conductor. It is clearly this source which must supply this power. In the simple circuit shown with a cell (Fig.3.11), it is the chemical energy of the cell which supplies this power for as long as it can.

The expressions for power, Eqs. (3.32) and (3.33), show the dependence of the power dissipated in a resistor R on the current through it and the voltage across it.

Equation (3.33) has an important application to power transmission. Electrical power is transmitted from power stations to homes and factories, which may be hundreds of miles away, via transmission cables. One obviously wants to minimise the power loss in the transmission cables connecting the power stations to homes and factories. We shall see now how this can be achieved. Consider a device R , to which a power P is to be delivered via transmission cables having a resistance R_c to be dissipated by it finally. If V is the voltage across R and I the current through it, then

$$P = VI \quad (3.34)$$

The connecting wires from the power station to the device has a finite resistance R_c . The power dissipated in the connecting wires, which is wasted is P_c with

$$\begin{aligned} P_c &= I^2 R_c \\ &= \frac{P^2 R_c}{V^2} \end{aligned} \quad (3.35)$$

from Eq. (3.32). Thus, to drive a device of power P , the power wasted in the connecting wires is inversely proportional to V^2 . The transmission cables from power stations are hundreds of miles long and their resistance R_c is considerable. To reduce P_c , these wires carry current at enormous values of V and this is the reason for the high voltage danger signs on transmission lines — a common sight as we move away from populated areas. Using electricity at such voltages is not safe and hence at the other end, a device called a transformer lowers the voltage to a value suitable for use.

3.10 CELLS, EMF, INTERNAL RESISTANCE

We have already mentioned that a simple device to maintain a steady current in an electric circuit is the electrolytic cell. Basically a cell has two electrodes, called the positive (P) and the negative (N), as shown in

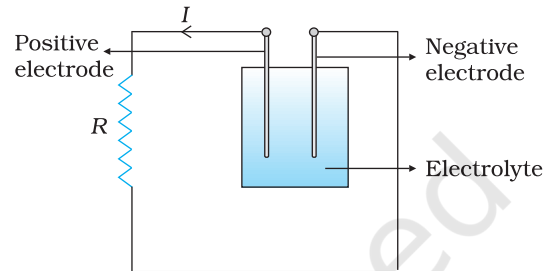

FIGURE 3.11 Heat is produced in the resistor R which is connected across the terminals of a cell. The energy dissipated in the resistor R comes from the chemical energy of the electrolyte.

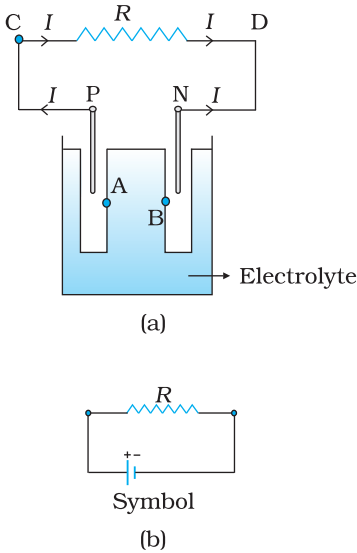

FIGURE 3.12 (a) Sketch of an electrolyte cell with positive terminal P and negative terminal N. The gap between the electrodes is exaggerated for clarity. A and B are points in the electrolyte typically close to P and N. (b) the symbol for a cell, + referring to P and - referring to the N electrode. Electrical connections to the cell are made at P and N.

Fig. 3.12. They are immersed in an electrolytic solution. Dipped in the solution, the electrodes exchange charges with the electrolyte. The positive electrode has a potential difference V_+ ($V_+ > 0$) between itself and the electrolyte solution immediately adjacent to it marked A in the figure. Similarly, the negative electrode develops a negative potential $-V_-$ ($V_- \geq 0$) relative to the electrolyte adjacent to it, marked as B in the figure. When there is no current, the electrolyte has the same potential throughout, so that the potential difference between P and N is $V_+ - (-V_-) = V_+ + V_-$. This difference is called the *electromotive force* (emf) of the cell and is denoted by ε . Thus

$$\varepsilon = V_+ + V_- > 0 \quad (3.36)$$

Note that ε is, actually, a potential difference and *not a force*. The name emf, however, is used because of historical reasons, and was given at a time when the phenomenon was not understood properly.

To understand the significance of ε , consider a resistor R connected across the cell (Fig. 3.12). A current I flows across R from C to D. As explained before, a steady current is maintained because current flows from N to P through the electrolyte. Clearly, across the electrolyte the same current flows through the electrolyte but from N to P, whereas through R , it flows from P to N.

The electrolyte through which a current flows has a finite resistance r , called the *internal resistance*. Consider first the situation when R is infinite so that $I = V/R = 0$, where V is the potential difference between P and N. Now,

$$\begin{aligned} V &= \text{Potential difference between P and A} \\ &+ \text{Potential difference between A and B} \\ &+ \text{Potential difference between B and N} \\ &= \varepsilon \end{aligned} \quad (3.37)$$

Thus, emf ε is the potential difference between the positive and negative electrodes in an open circuit, i.e., when no current is flowing through the cell.

If however R is finite, I is not zero. In that case the potential difference between P and N is

$$\begin{aligned} V &= V_+ + V_- - I r \\ &= \varepsilon - I r \end{aligned} \quad (3.38)$$

Note the negative sign in the expression ($I r$) for the potential difference between A and B. This is because the current I flows from B to A in the electrolyte.

In practical calculations, internal resistances of cells in the circuit may be neglected when the current I is such that $\varepsilon \gg I r$. The actual values of the internal resistances of cells vary from cell to cell. The internal resistance of dry cells, however, is much higher than the common electrolytic cells.

We also observe that since V is the potential difference across R , we have from Ohm's law

$$V = I R \quad (3.39)$$

Combining Eqs. (3.38) and (3.39), we get

$$I R = \varepsilon - I r$$

$$\text{Or, } I = \frac{\varepsilon}{R + r} \quad (3.40)$$

The maximum current that can be drawn from a cell is for $R = 0$ and it is $I_{\max} = \varepsilon/r$. However, in most cells the maximum allowed current is much lower than this to prevent permanent damage to the cell.

3.11 CELLS IN SERIES AND IN PARALLEL

Like resistors, cells can be combined together in an electric circuit. And like resistors, one can, for calculating currents and voltages in a circuit, replace a combination of cells by an equivalent cell.

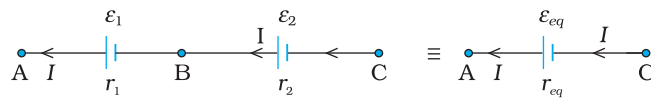

FIGURE 3.13 Two cells of emf's ε_1 and ε_2 in the series. r_1 , r_2 are their internal resistances. For connections across A and C, the combination can be considered as one cell of emf ε_{eq} and an internal resistance r_{eq} .

Consider first two cells in series (Fig. 3.13), where one terminal of the two cells is joined together leaving the other terminal in either cell free. ε_1 , ε_2 are the emf's of the two cells and r_1 , r_2 their internal resistances, respectively.

Let $V(A)$, $V(B)$, $V(C)$ be the potentials at points A, B and C shown in Fig. 3.13. Then $V(A) - V(B)$ is the potential difference between the positive and negative terminals of the first cell. We have already calculated it in Eq. (3.38) and hence,

$$V_{AB} \equiv V(A) - V(B) = \varepsilon_1 - I r_1 \quad (3.41)$$

Similarly,

$$V_{BC} \equiv V(B) - V(C) = \varepsilon_2 - I r_2 \quad (3.42)$$

Hence, the potential difference between the terminals A and C of the combination is

$$\begin{aligned} V_{AC} &\equiv V(A) - V(C) = V(A) - V(B) + V(B) - V(C) \\ &= (\varepsilon_1 + \varepsilon_2) - I(r_1 + r_2) \end{aligned} \quad (3.43)$$

If we wish to replace the combination by a single cell between A and C of emf ε_{eq} and internal resistance r_{eq} , we would have

$$V_{AC} = \varepsilon_{eq} - I r_{eq} \quad (3.44)$$

Comparing the last two equations, we get

$$\varepsilon_{eq} = \varepsilon_1 + \varepsilon_2 \quad (3.45)$$

$$\text{and } r_{eq} = r_1 + r_2 \quad (3.46)$$

In Fig.3.13, we had connected the negative electrode of the first to the positive electrode of the second. If instead we connect the two negatives,

Eq. (3.42) would change to $V_{BC} = -\varepsilon_2 - Ir_2$ and we will get

$$\varepsilon_{eq} = \varepsilon_1 - \varepsilon_2 \quad (\varepsilon_1 > \varepsilon_2) \quad (3.47)$$

The rule for series combination clearly can be extended to any number of cells:

- (i) The equivalent emf of a series combination of n cells is just the sum of their individual emf's, and
- (ii) The equivalent internal resistance of a series combination of n cells is just the sum of their internal resistances.

This is so, when the current leaves each cell from the positive electrode. If in the combination, the current leaves any cell from the *negative* electrode, the emf of the cell enters the expression for ε_{eq} with a *negative* sign, as in Eq. (3.47).

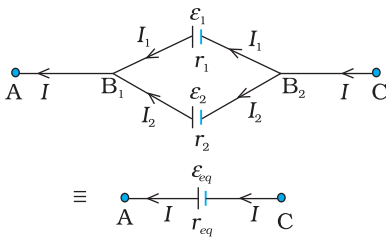

FIGURE 3.14 Two cells in parallel. For connections across A and C, the combination can be replaced by one cell of emf ε_{eq} and internal resistances r_{eq} whose values are given in Eqs. (3.54) and (3.55).

Next, consider a parallel combination of the cells (Fig. 3.14). I_1 and I_2 are the currents leaving the positive electrodes of the cells. At the point B_1 , I_1 and I_2 flow in whereas the current I flows out. Since as much charge flows in as out, we have

$$I = I_1 + I_2 \quad (3.48)$$

Let $V(B_1)$ and $V(B_2)$ be the potentials at B_1 and B_2 , respectively. Then, considering the first cell, the potential difference across its terminals is $V(B_1) - V(B_2)$. Hence, from Eq. (3.38)

$$V \equiv V(B_1) - V(B_2) = \varepsilon_1 - I_1 r_1 \quad (3.49)$$

Points B_1 and B_2 are connected exactly similarly to the second cell. Hence considering the second cell, we also have

$$V \equiv V(B_1) - V(B_2) = \varepsilon_2 - I_2 r_2 \quad (3.50)$$

Combining the last three equations

$$\begin{aligned} I &= I_1 + I_2 \\ &= \frac{\varepsilon_1 - V}{r_1} + \frac{\varepsilon_2 - V}{r_2} = \left(\frac{\varepsilon_1}{r_1} + \frac{\varepsilon_2}{r_2} \right) - V \left(\frac{1}{r_1} + \frac{1}{r_2} \right) \end{aligned} \quad (3.51)$$

Hence, V is given by,

$$V = \frac{\varepsilon_1 r_2 + \varepsilon_2 r_1}{r_1 + r_2} - I \frac{r_1 r_2}{r_1 + r_2} \quad (3.52)$$

If we want to replace the combination by a single cell, between B_1 and B_2 , of emf ε_{eq} and internal resistance r_{eq} , we would have

$$V = \varepsilon_{eq} - I r_{eq} \quad (3.53)$$

The last two equations should be the same and hence

$$\varepsilon_{eq} = \frac{\varepsilon_1 r_2 + \varepsilon_2 r_1}{r_1 + r_2} \quad (3.54)$$

$$r_{eq} = \frac{r_1 r_2}{r_1 + r_2} \quad (3.55)$$

We can put these equations in a simpler way,

$$\frac{1}{r_{eq}} = \frac{1}{r_1} + \frac{1}{r_2} \quad (3.56)$$

$$\frac{\mathcal{E}_{eq}}{r_{eq}} = \frac{\mathcal{E}_1}{r_1} + \frac{\mathcal{E}_2}{r_2} \quad (3.57)$$

In Fig. (3.14), we had joined the positive terminals together and similarly the two negative ones, so that the currents I_1, I_2 flow out of positive terminals. If the negative terminal of the second is connected to positive terminal of the first, Eqs. (3.56) and (3.57) would still be valid with $\mathcal{E}_2 \rightarrow -\mathcal{E}_2$

Equations (3.56) and (3.57) can be extended easily. If there are n cells of emf $\mathcal{E}_1, \dots, \mathcal{E}_n$ and of internal resistances r_1, \dots, r_n respectively, connected in parallel, the combination is equivalent to a single cell of emf \mathcal{E}_{eq} and internal resistance r_{eq} , such that

$$\frac{1}{r_{eq}} = \frac{1}{r_1} + \dots + \frac{1}{r_n} \quad (3.58)$$

$$\frac{\mathcal{E}_{eq}}{r_{eq}} = \frac{\mathcal{E}_1}{r_1} + \dots + \frac{\mathcal{E}_n}{r_n} \quad (3.59)$$

3.12 KIRCHHOFF'S RULES

Electric circuits generally consist of a number of resistors and cells interconnected sometimes in a complicated way.

The formulae we have derived earlier for series and parallel combinations of resistors are not always sufficient to determine all the currents and potential differences in the circuit. Two rules, called *Kirchhoff's rules*, are very useful for analysis of electric circuits.

Given a circuit, we start by labelling currents in each resistor by a symbol, say I , and a directed arrow to indicate that a current I flows along the resistor in the direction indicated. If ultimately I is determined to be positive, the actual current in the resistor is in the direction of the arrow. If I turns out to be negative, the current actually flows in a direction opposite to the arrow. Similarly, for each source (i.e., cell or some other source of electrical power) the positive and negative electrodes are labelled, as well as, a directed arrow with a symbol for the current flowing through the cell. This will tell us the potential difference, $V = V(P) - V(N) = \mathcal{E} - I r$ [Eq. (3.38) between the positive terminal P and the negative terminal N; I here is the current flowing from N to P through the cell]. If, while labelling the current I through the cell one goes from P to N, then of course

$$V = \mathcal{E} + I r \quad (3.60)$$

Having clarified labelling, we now state the rules and the proof:

- (a) *Junction rule: At any junction, the sum of the currents entering the junction is equal to the sum of currents leaving the junction* (Fig. 3.15).

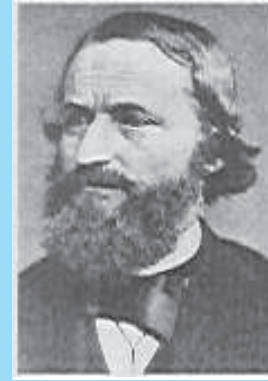

Gustav Robert Kirchhoff (1824 - 1887) German physicist, professor at Heidelberg and at Berlin. Mainly known for his development of spectroscopy, he also made many important contributions to mathematical physics, among them, his first and second rules for circuits.

GUSTAV ROBERT KIRCHHOFF (1824 -

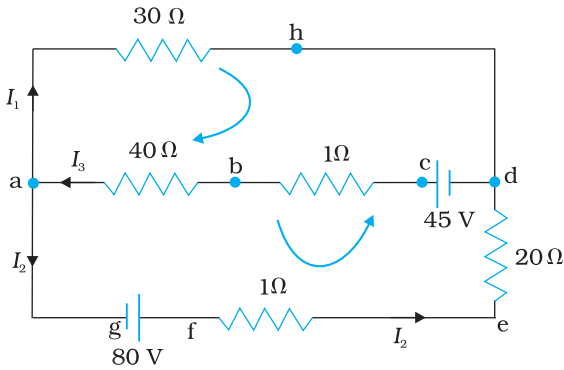

FIGURE 3.15 At junction a the current leaving is $I_1 + I_2$ and current entering is I_3 . The junction rule says $I_3 = I_1 + I_2$. At point h current entering is I_1 . There is only one current leaving h and by junction rule that will also be I_1 . For the loops 'ahdcba' and 'ahdefga', the loop rules give $-30I_1 - 41I_3 + 45 = 0$ and $-30I_1 + 21I_2 - 80 = 0$.

This applies equally well if instead of a junction of several lines, we consider a point in a line.

The proof of this rule follows from the fact that when currents are steady, there is no accumulation of charges at any junction or at any point in a line. Thus, the total current flowing in, (which is the rate at which charge flows into the junction), must equal the total current flowing out.

(b) *Loop rule: The algebraic sum of changes in potential around any closed loop involving resistors and cells in the loop is zero* (Fig. 3.15).

This rule is also obvious, since electric potential is dependent on the location of the point. Thus starting with any point if we come back to the same point, the total change must be zero. In a closed loop, we do come back to the starting point and hence the rule.

Example 3.5 A battery of 10 V and negligible internal resistance is connected across the diagonally opposite corners of a cubical network consisting of 12 resistors each of resistance 1Ω (Fig. 3.16). Determine the equivalent resistance of the network and the current along each edge of the cube.

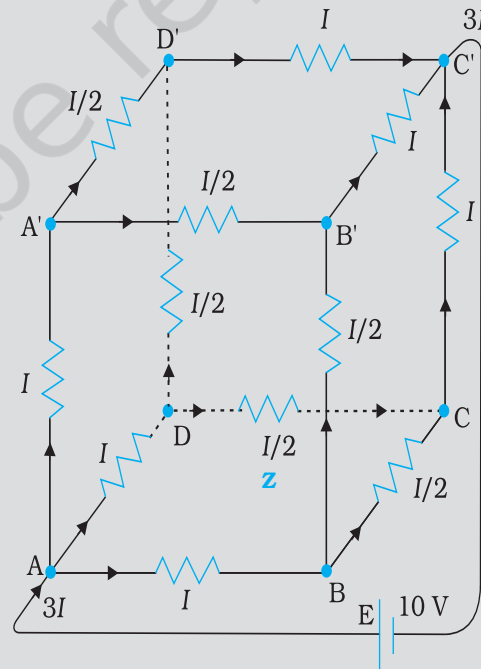

FIGURE 3.16

EXAMPLE 3.5

Solution The network is not reducible to a simple series and parallel combinations of resistors. There is, however, a clear symmetry in the problem which we can exploit to obtain the equivalent resistance of the network.

The paths AA', AD and AB are obviously symmetrically placed in the network. Thus, the current in each must be the same, say, I . Further, at the corners A', B and D, the incoming current I must split equally into the two outgoing branches. In this manner, the current in all the 12 edges of the cube are easily written down in terms of I , using Kirchhoff's first rule and the symmetry in the problem.

Next take a closed loop, say, ABCC'EA, and apply Kirchhoff's second rule:

$$-IR - (1/2)IR - IR + \varepsilon = 0$$

where R is the resistance of each edge and ε the emf of battery. Thus,

$$\varepsilon = \frac{5}{2} IR$$

The equivalent resistance R_{eq} of the network is

$$R_{eq} = \frac{\varepsilon}{3I} = \frac{5}{6} R$$

For $R = 1 \Omega$, $R_{eq} = (5/6) \Omega$ and for $\varepsilon = 10 \text{ V}$, the total current ($= 3I$) in the network is

$$3I = 10 \text{ V} / (5/6) \Omega = 12 \text{ A, i.e., } I = 4 \text{ A}$$

The current flowing in each edge can now be read off from the Fig. 3.16.

It should be noted that because of the symmetry of the network, the great power of Kirchhoff's rules has not been very apparent in Example 3.5. In a general network, there will be no such simplification due to symmetry, and only by application of Kirchhoff's rules to junctions and closed loops (as many as necessary to solve the unknowns in the network) can we handle the problem. This will be illustrated in Example 3.6.

Example 3.6 Determine the current in each branch of the network shown in Fig. 3.17.

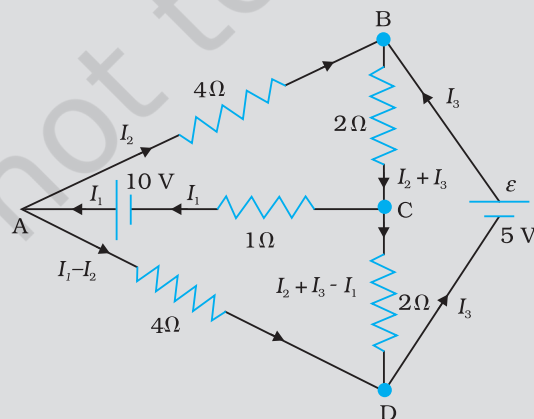

FIGURE 3.17

PHYSICS

Simulation for application of Kirchhoff's rules:
<http://www.phys.hawaii.edu/~teb/optics/java/kirch3/>

EXAMPLE 3.5

EXAMPLE 3.6

Solution Each branch of the network is assigned an unknown current to be determined by the application of Kirchhoff's rules. To reduce the number of unknowns at the outset, the first rule of Kirchhoff is used at every junction to assign the unknown current in each branch. We then have three unknowns I_1 , I_2 and I_3 which can be found by applying the second rule of Kirchhoff to three different closed loops. Kirchhoff's second rule for the closed loop ADCA gives,

$$10 - 4(I_1 - I_2) + 2(I_2 + I_3 - I_1) - I_1 = 0 \quad [3.61(a)]$$

that is, $7I_1 - 6I_2 - 2I_3 = 10$

For the closed loop ABCA, we get

$$10 - 4I_2 - 2(I_2 + I_3) - I_1 = 0$$

that is, $I_1 + 6I_2 + 2I_3 = 10$ [3.61(b)]

For the closed loop BCDEB, we get

$$5 - 2(I_2 + I_3) - 2(I_2 + I_3 - I_1) = 0$$

that is, $2I_1 - 4I_2 - 4I_3 = -5$ [3.61(c)]

Equations (3.61 a, b, c) are three simultaneous equations in three unknowns. These can be solved by the usual method to give

$$I_1 = 2.5A, \quad I_2 = \frac{5}{8} A, \quad I_3 = 1\frac{7}{8} A$$

The currents in the various branches of the network are

$$AB : \frac{5}{8} A, \quad CA : 2\frac{1}{2} A, \quad DEB : 1\frac{7}{8} A$$

$$AD : 1\frac{7}{8} A, \quad CD : 0 A, \quad BC : 2\frac{1}{2} A$$

It is easily verified that Kirchhoff's second rule applied to the remaining closed loops does not provide any additional independent equation, that is, the above values of currents satisfy the second rule for every closed loop of the network. For example, the total voltage drop over the closed loop BADEB

$$5V + \left(\frac{5}{8} \times 4\right)V - \left(\frac{15}{8} \times 4\right)V$$

equal to zero, as required by Kirchhoff's second rule.

3.13 WHEATSTONE BRIDGE

As an application of Kirchhoff's rules consider the circuit shown in Fig. 3.18, which is called the *Wheatstone bridge*. The bridge has four resistors R_1 , R_2 , R_3 and R_4 . Across one pair of diagonally opposite points (A and C in the figure) a source is connected. This (*i.e.*, AC) is called the battery arm. Between the other two vertices, B and D, a galvanometer G (which is a device to detect currents) is connected. This line, shown as BD in the figure, is called the galvanometer arm.

For simplicity, we assume that the cell has no internal resistance. In general there will be currents flowing across all the resistors as well as a current I_g through G. Of special interest, is the case of a *balanced* bridge where the resistors are such that $I_g = 0$. We can easily get the balance condition, such that there is no current through G. In this case, the Kirchhoff's junction rule applied to junctions D and B (see the figure)

immediately gives us the relations $I_1 = I_3$ and $I_2 = I_4$. Next, we apply Kirchhoff's loop rule to closed loops ADBA and CBDC. The first loop gives

$$-I_1 R_1 + 0 + I_2 R_2 = 0 \quad (I_g = 0) \quad (3.62)$$

and the second loop gives, upon using $I_3 = I_1$, $I_4 = I_2$

$$I_2 R_4 + 0 - I_1 R_3 = 0 \quad (3.63)$$

From Eq. (3.62), we obtain,

$$\frac{I_1}{I_2} = \frac{R_2}{R_1}$$

whereas from Eq. (3.63), we obtain,

$$\frac{I_1}{I_2} = \frac{R_4}{R_3}$$

Hence, we obtain the condition

$$\frac{R_2}{R_1} = \frac{R_4}{R_3} \quad [3.64(a)]$$

This last equation relating the four resistors is called the *balance condition* for the galvanometer to give zero or null deflection.

The Wheatstone bridge and its balance condition provide a practical method for determination of an unknown resistance. Let us suppose we have an unknown resistance, which we insert in the fourth arm; R_4 is thus not known. Keeping known resistances R_1 and R_2 in the first and second arm of the bridge, we go on varying R_3 till the galvanometer shows a null deflection. The bridge then is balanced, and from the balance condition the value of the unknown resistance R_4 is given by,

$$R_4 = R_3 \frac{R_2}{R_1} \quad [3.64(b)]$$

A practical device using this principle is called the *meter bridge*.

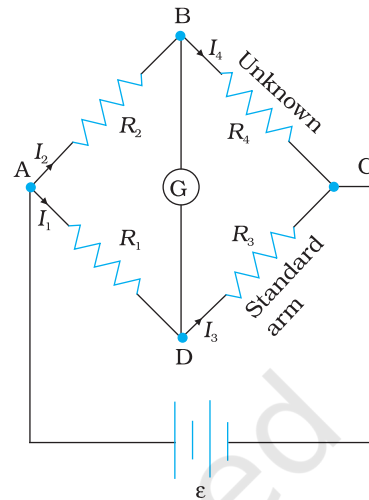

FIGURE 3.18

Example 3.7 The four arms of a Wheatstone bridge (Fig. 3.19) have the following resistances:

AB = 100Ω, BC = 10Ω, CD = 5Ω, and DA = 60Ω.

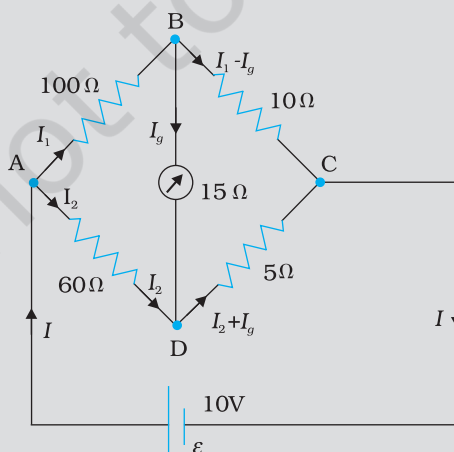

FIGURE 3.19

A galvanometer of 15Ω resistance is connected across BD. Calculate the current through the galvanometer when a potential difference of 10 V is maintained across AC.

Solution Considering the mesh BADB, we have

$$100I_1 + 15I_g - 60I_2 = 0$$

$$\text{or } 20I_1 + 3I_g - 12I_2 = 0 \quad [3.65(a)]$$

Considering the mesh BCDB, we have

$$10(I_1 - I_g) - 15I_g - 5(I_2 + I_g) = 0$$

$$10I_1 - 30I_g - 5I_2 = 0$$

$$2I_1 - 6I_g - I_2 = 0 \quad [3.65(b)]$$

Considering the mesh ADCEA,

$$60I_2 + 5(I_2 + I_g) = 10$$

$$65I_2 + 5I_g = 10$$

$$13I_2 + I_g = 2 \quad [3.65(c)]$$

Multiplying Eq. (3.65b) by 10

$$20I_1 - 60I_g - 10I_2 = 0 \quad [3.65(d)]$$

From Eqs. (3.65d) and (3.65a) we have

$$63I_g - 2I_2 = 0$$

$$I_2 = 31.5I_g \quad [3.65(e)]$$

Substituting the value of I_2 into Eq. [3.65(c)], we get

$$13(31.5I_g) + I_g = 2$$

$$410.5 I_g = 2$$

$$I_g = 4.87 \text{ mA.}$$

SUMMARY

1. *Current* through a given area of a conductor is the net charge passing per unit time through the area.
2. To maintain a steady current, we must have a closed circuit in which an external agency moves electric charge from lower to higher potential energy. The work done per unit charge by the source in taking the charge from lower to higher potential energy (i.e., from one terminal of the source to the other) is called the electromotive force, or *emf*, of the source. Note that the emf is not a force; it is the voltage difference between the two terminals of a source in open circuit.
3. *Ohm's law*: The electric current I flowing through a substance is proportional to the voltage V across its ends, i.e., $V \propto I$ or $V = RI$, where R is called the *resistance* of the substance. The unit of resistance is ohm: $1\Omega = 1 \text{ V A}^{-1}$.

4. The *resistance* R of a conductor depends on its length l and cross-sectional area A through the relation,

$$R = \frac{\rho l}{A}$$

where ρ , called *resistivity* is a property of the material and depends on temperature and pressure.

5. *Electrical resistivity* of substances varies over a very wide range. Metals have low resistivity, in the range of $10^{-8} \Omega \text{ m}$ to $10^{-6} \Omega \text{ m}$. Insulators like glass and rubber have 10^{22} to 10^{24} times greater resistivity. Semiconductors like Si and Ge lie roughly in the middle range of resistivity on a logarithmic scale.
6. In most substances, the carriers of current are electrons; in some cases, for example, ionic crystals and electrolytic liquids, positive and negative ions carry the electric current.
7. *Current density* \mathbf{j} gives the amount of charge flowing per second per unit area normal to the flow,

$$\mathbf{j} = nq \mathbf{v}_d$$

where n is the number density (number per unit volume) of charge carriers each of charge q , and \mathbf{v}_d is the *drift velocity* of the charge carriers. For electrons $q = -e$. If \mathbf{j} is normal to a cross-sectional area \mathbf{A} and is constant over the area, the magnitude of the current I through the area is $nev_d A$.

8. Using $E = V/l$, $I = nev_d A$, and Ohm's law, one obtains

$$\frac{eE}{m} = \rho \frac{ne^2}{m} v_d$$

The proportionality between the *force* eE on the electrons in a metal due to the external field E and the drift velocity v_d (not acceleration) can be understood, if we assume that the electrons suffer collisions with ions in the metal, which deflect them randomly. If such collisions occur on an average at a time interval τ ,

$$v_d = a\tau = eE\tau/m$$

where a is the acceleration of the electron. This gives

$$\rho = \frac{m}{ne^2\tau}$$

9. In the temperature range in which resistivity increases linearly with temperature, the *temperature coefficient of resistivity* α is defined as the fractional increase in resistivity per unit increase in temperature.
10. Ohm's law is obeyed by many substances, but it is not a fundamental law of nature. It fails if
- V depends on I non-linearly.
 - the relation between V and I depends on the sign of V for the same absolute value of V .
 - The relation between V and I is non-unique.

An example of (a) is when ρ increases with I (even if temperature is kept fixed). A rectifier combines features (a) and (b). GaAs shows the feature (c).

11. When a source of emf ε is connected to an external resistance R , the voltage V_{ext} across R is given by

$$V_{ext} = IR = \frac{\varepsilon}{R+r} R$$

where r is the *internal resistance* of the source.

12. Kirchhoff's Rules –

- (a) *Junction Rule*: At any junction of circuit elements, the sum of currents entering the junction must equal the sum of currents leaving it.
- (b) *Loop Rule*: The algebraic sum of changes in potential around any closed loop must be zero.

13. The *Wheatstone bridge* is an arrangement of four resistances – R_1 , R_2 , R_3 , R_4 as shown in the text. The null-point condition is given by

$$\frac{R_1}{R_2} = \frac{R_3}{R_4}$$

using which the value of one resistance can be determined, knowing the other three resistances.

Physical Quantity	Symbol	Dimensions	Unit	Remark
Electric current	I	[A]	A	SI base unit
Charge	Q, q	[T A]	C	
Voltage, Electric potential difference	V	[M L ² T ⁻³ A ⁻¹]	V	Work/charge
Electromotive force	ε	[M L ² T ⁻³ A ⁻¹]	V	Work/charge
Resistance	R	[M L ² T ⁻³ A ⁻²]	Ω	$R = V/I$
Resistivity	ρ	[M L ³ T ⁻³ A ⁻²]	Ω m	$R = \rho l/A$
Electrical conductivity	σ	[M ⁻¹ L ⁻³ T ³ A ²]	S	$\sigma = 1/\rho$
Electric field	\mathbf{E}	[M L T ⁻³ A ⁻¹]	V m ⁻¹	$\frac{\text{Electric force}}{\text{charge}}$
Drift speed	v_d	[L T ⁻¹]	m s ⁻¹	$v_d = \frac{e E \tau}{m}$
Relaxation time	τ	[T]	s	
Current density	\mathbf{j}	[L ⁻² A]	A m ⁻²	current/area
Mobility	μ	[M L ³ T ⁻⁴ A ⁻¹]	m ² V ⁻¹ s ⁻¹	v_d / E

POINTS TO PONDER

1. Current is a scalar although we represent current with an arrow. Currents do not obey the law of vector addition. That current is a scalar also follows from its definition. The current I through an area of cross-section is given by the scalar product of two vectors:

$$I = \mathbf{j} \cdot \Delta \mathbf{S}$$

where \mathbf{j} and $\Delta \mathbf{S}$ are vectors.

2. Refer to V - I curves of a resistor and a diode as drawn in the text. A resistor obeys Ohm's law while a diode does not. The assertion that $V = IR$ is a statement of Ohm's law is not true. This equation defines resistance and it may be applied to all conducting devices whether they obey Ohm's law or not. The Ohm's law asserts that the plot of I versus V is linear i.e., R is independent of V .

Equation $\mathbf{E} = \rho \mathbf{j}$ leads to another statement of *Ohm's law*, i.e., a conducting material obeys Ohm's law when the resistivity of the material does not depend on the magnitude and direction of applied electric field.

3. Homogeneous conductors like silver or semiconductors like pure germanium or germanium containing impurities obey Ohm's law within some range of electric field values. If the field becomes too strong, there are departures from Ohm's law in all cases.
4. Motion of conduction electrons in electric field \mathbf{E} is the sum of (i) motion due to random collisions and (ii) that due to \mathbf{E} . The motion due to random collisions averages to zero and does not contribute to v_d (Chapter 10, Textbook of Class XI). v_d , thus is only due to applied electric field on the electron.
5. The relation $\mathbf{j} = \rho \mathbf{v}$ should be applied to each type of charge carriers separately. In a conducting wire, the total current and charge density arises from both positive and negative charges:

$$\mathbf{j} = \rho_+ \mathbf{v}_+ + \rho_- \mathbf{v}_-$$

$$\rho = \rho_+ + \rho_-$$

Now in a neutral wire carrying electric current,

$$\rho_+ = -\rho_-$$

Further, $v_+ \sim 0$ which gives

$$\rho = 0$$

$$\mathbf{j} = \rho_- \mathbf{v}_-$$

Thus, the relation $\mathbf{j} = \rho \mathbf{v}$ does not apply to the total current charge density.

6. Kirchhoff's junction rule is based on conservation of charge and the outgoing currents add up and are equal to incoming current at a junction. Bending or reorienting the wire does not change the validity of Kirchhoff's junction rule.

EXERCISES

- 3.1 The storage battery of a car has an emf of 12 V. If the internal resistance of the battery is 0.4Ω , what is the maximum current that can be drawn from the battery?
- 3.2 A battery of emf 10 V and internal resistance 3Ω is connected to a resistor. If the current in the circuit is 0.5 A, what is the resistance of the resistor? What is the terminal voltage of the battery when the circuit is closed?
- 3.3 At room temperature (27.0°C) the resistance of a heating element is 100Ω . What is the temperature of the element if the resistance is found to be 117Ω , given that the temperature coefficient of the material of the resistor is $1.70 \times 10^{-4} \text{ }^\circ\text{C}^{-1}$.

- 3.4** A negligibly small current is passed through a wire of length 15 m and uniform cross-section $6.0 \times 10^{-7} \text{ m}^2$, and its resistance is measured to be 5.0Ω . What is the resistivity of the material at the temperature of the experiment?
- 3.5** A silver wire has a resistance of 2.1Ω at 27.5°C , and a resistance of 2.7Ω at 100°C . Determine the temperature coefficient of resistivity of silver.
- 3.6** A heating element using nichrome connected to a 230 V supply draws an initial current of 3.2 A which settles after a few seconds to a steady value of 2.8 A. What is the steady temperature of the heating element if the room temperature is 27.0°C ? Temperature coefficient of resistance of nichrome averaged over the temperature range involved is $1.70 \times 10^{-4} \text{ }^\circ\text{C}^{-1}$.
- 3.7** Determine the current in each branch of the network shown in Fig. 3.20:

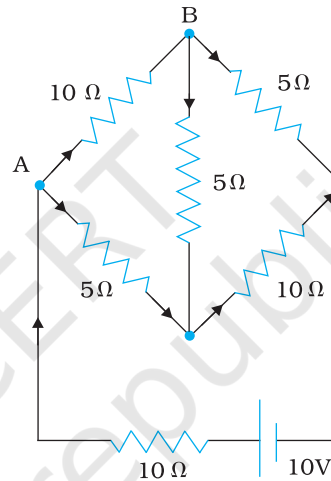
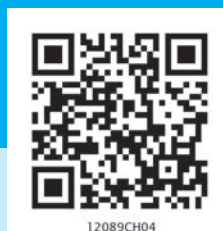

FIGURE 3.20

- 3.8** A storage battery of emf 8.0 V and internal resistance 0.5Ω is being charged by a 120 V dc supply using a series resistor of 15.5Ω . What is the terminal voltage of the battery during charging? What is the purpose of having a series resistor in the charging circuit?
- 3.9** The number density of free electrons in a copper conductor estimated in Example 3.1 is $8.5 \times 10^{28} \text{ m}^{-3}$. How long does an electron take to drift from one end of a wire 3.0 m long to its other end? The area of cross-section of the wire is $2.0 \times 10^{-6} \text{ m}^2$ and it is carrying a current of 3.0 A.



Chapter Four

MOVING CHARGES AND MAGNETISM



4.1 INTRODUCTION

Both Electricity and Magnetism have been known for more than 2000 years. However, it was only about 200 years ago, in 1820, that it was realised that they were intimately related. During a lecture demonstration in the summer of 1820, Danish physicist Hans Christian Oersted noticed that a current in a straight wire caused a noticeable deflection in a nearby magnetic compass needle. He investigated this phenomenon. He found that the alignment of the needle is tangential to an imaginary circle which has the straight wire as its centre and has its plane perpendicular to the wire. This situation is depicted in Fig.4.1(a). It is noticeable when the current is large and the needle sufficiently close to the wire so that the earth's magnetic field may be ignored. Reversing the direction of the current reverses the orientation of the needle [Fig. 4.1(b)]. The deflection increases on increasing the current or bringing the needle closer to the wire. Iron filings sprinkled around the wire arrange themselves in concentric circles with the wire as the centre [Fig. 4.1(c)]. Oersted concluded that *moving charges or currents produced a magnetic field in the surrounding space.*

Following this, there was intense experimentation. In 1864, the laws obeyed by electricity and magnetism were unified and formulated by

James Maxwell who then realised that light was electromagnetic waves. Radio waves were discovered by Hertz, and produced by J.C. Bose and G. Marconi by the end of the 19th century. A remarkable scientific and technological progress took place in the 20th century. This was due to our increased understanding of electromagnetism and the invention of devices for production, amplification, transmission and detection of electromagnetic waves.

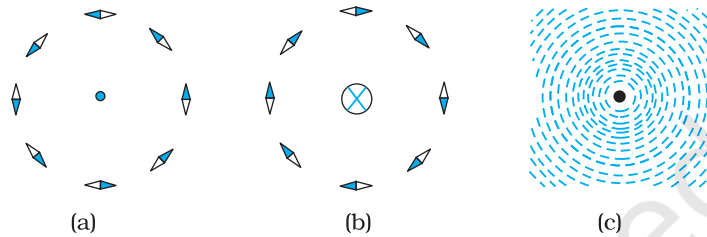

FIGURE 4.1 The magnetic field due to a straight long current-carrying wire. The wire is perpendicular to the plane of the paper. A ring of compass needles surrounds the wire. The orientation of the needles is shown when (a) the current emerges out of the plane of the paper, (b) the current moves into the plane of the paper. (c) The arrangement of iron filings around the wire. The darkened ends of the needle represent north poles. The effect of the earth's magnetic field is neglected.

HANS CHRISTIAN OERSTED (1777–1851)



Hans Christian Oersted (1777–1851) Danish physicist and chemist, professor at Copenhagen. He observed that a compass needle suffers a deflection when placed near a wire carrying an electric current. This discovery gave the first empirical evidence of a connection between electric and magnetic phenomena.

In this chapter, we will see how magnetic field exerts forces on moving charged particles, like electrons, protons, and current-carrying wires. We shall also learn how currents produce magnetic fields. We shall see how particles can be accelerated to very high energies in a cyclotron. We shall study how currents and voltages are detected by a galvanometer.

In this and subsequent Chapter on magnetism, we adopt the following convention: A current or a field (electric or magnetic) emerging out of the plane of the paper is depicted by a dot (\odot). A current or a field going into the plane of the paper is depicted by a cross (\otimes)*. Figures. 4.1(a) and 4.1(b) correspond to these two situations, respectively.

4.2 MAGNETIC FORCE

4.2.1 Sources and fields

Before we introduce the concept of a magnetic field \mathbf{B} , we shall recapitulate what we have learnt in Chapter 1 about the electric field \mathbf{E} . We have seen that the interaction between two charges can be considered in two stages. The charge Q , the source of the field, produces an electric field \mathbf{E} , where

* A dot appears like the tip of an arrow pointed at you, a cross is like the feathered tail of an arrow moving away from you.

$$\mathbf{E} = Q \hat{\mathbf{r}} / (4\pi\epsilon_0)r^2 \quad (4.1)$$

where $\hat{\mathbf{r}}$ is unit vector along \mathbf{r} , and the field \mathbf{E} is a vector field. A charge q interacts with this field and experiences a force \mathbf{F} given by

$$\mathbf{F} = q \mathbf{E} = qQ \hat{\mathbf{r}} / (4\pi\epsilon_0) r^2 \quad (4.2)$$

As pointed out in the Chapter 1, the field \mathbf{E} is not just an artefact but has a physical role. It can convey energy and momentum and is not established instantaneously but takes finite time to propagate. The concept of a field was specially stressed by Faraday and was incorporated by Maxwell in his unification of electricity and magnetism. In addition to depending on each point in space, it can also vary with time, i.e., be a function of time. In our discussions in this chapter, we will assume that the fields do not change with time.

The field at a particular point can be due to one or more charges. If there are more charges the fields add vectorially. You have already learnt in Chapter 1 that this is called the principle of superposition. Once the field is known, the force on a test charge is given by Eq. (4.2).

Just as static charges produce an electric field, the currents or moving charges produce (in addition) a magnetic field, denoted by $\mathbf{B}(\mathbf{r})$, again a vector field. It has several basic properties identical to the electric field. It is defined at each point in space (and can in addition depend on time). Experimentally, it is found to obey the principle of superposition: *the magnetic field of several sources is the vector addition of magnetic field of each individual source.*

4.2.2 Magnetic Field, Lorentz Force

Let us suppose that there is a point charge q (moving with a velocity \mathbf{v} and, located at \mathbf{r} at a given time t) in presence of both the electric field $\mathbf{E}(\mathbf{r})$ and the magnetic field $\mathbf{B}(\mathbf{r})$. The force on an electric charge q due to both of them can be written as

$$\mathbf{F} = q [\mathbf{E}(\mathbf{r}) + \mathbf{v} \times \mathbf{B}(\mathbf{r})] \equiv \mathbf{F}_{\text{electric}} + \mathbf{F}_{\text{magnetic}} \quad (4.3)$$

This force was given first by H.A. Lorentz based on the extensive experiments of Ampere and others. It is called the *Lorentz force*. You have already studied in detail the force due to the electric field. If we look at the interaction with the magnetic field, we find the following features.

- (i) It depends on q , \mathbf{v} and \mathbf{B} (charge of the particle, the velocity and the magnetic field). *Force on a negative charge is opposite to that on a positive charge.*
- (ii) The magnetic force $q [\mathbf{v} \times \mathbf{B}]$ includes a vector product of velocity and magnetic field. The vector product makes the force due to magnetic



Hendrik Antoon Lorentz (1853 - 1928) Dutch theoretical physicist, professor at Leiden. He investigated the relationship between electricity, magnetism, and mechanics. In order to explain the observed effect of magnetic fields on emitters of light (Zeeman effect), he postulated the existence of electric charges in the atom, for which he was awarded the Nobel Prize in 1902. He derived a set of transformation equations (known after him, as Lorentz transformation equations) by some tangled mathematical arguments, but he was not aware that these equations hinge on a new concept of space and time.

HENDRIK ANTOON LORENTZ (1853 - 1928)

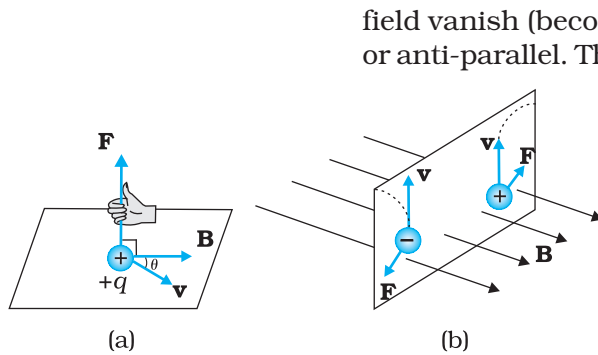

FIGURE 4.2 The direction of the magnetic force acting on a charged particle. (a) The force on a positively charged particle with velocity \mathbf{v} and making an angle θ with the magnetic field \mathbf{B} is given by the right-hand rule. (b) A moving charged particle q is deflected in an opposite sense to $-q$ in the presence of magnetic field.

field vanish (become zero) if velocity and magnetic field are parallel or anti-parallel. The force acts in a (sideways) direction perpendicular to both the velocity and the magnetic field. Its direction is given by the screw rule or right hand rule for vector (or cross) product as illustrated in Fig. 4.2.

(iii) The magnetic force is zero if charge is not moving (as then $|\mathbf{v}| = 0$). Only a moving charge feels the magnetic force.

The expression for the magnetic force helps us to define the unit of the magnetic field, if one takes q , \mathbf{F} and \mathbf{v} , all to be unity in the force equation $\mathbf{F} = q [\mathbf{v} \times \mathbf{B}] = qvB \sin \theta \hat{\mathbf{n}}$, where θ is the angle between \mathbf{v} and \mathbf{B} [see Fig. 4.2 (a)]. The magnitude of magnetic field B is 1 SI unit, when the force acting on a unit charge (1 C), moving perpendicular to \mathbf{B} with a speed 1m/s, is one newton.

Dimensionally, we have $[B] = [F/qv]$ and the unit of \mathbf{B} are Newton second / (coulomb metre). This unit is called *tesla* (T) named after Nikola Tesla (1856 – 1943). Tesla is a rather large unit. A smaller unit (non-SI) called *gauss* ($=10^{-4}$ tesla) is also often used. The earth's magnetic field is about 3.6×10^{-5} T.

4.2.3 Magnetic force on a current-carrying conductor

We can extend the analysis for force due to magnetic field on a single moving charge to a straight rod carrying current. Consider a rod of a uniform cross-sectional area A and length l . We shall assume one kind of mobile carriers as in a conductor (here electrons). Let the number density of these mobile charge carriers in it be n . Then the total number of mobile charge carriers in it is $n l A$. For a steady current I in this conducting rod, we may assume that each mobile carrier has an average drift velocity \mathbf{v}_d (see Chapter 3). In the presence of an external magnetic field \mathbf{B} , the force on these carriers is:

$$\mathbf{F} = (n l A) q \mathbf{v}_d \times \mathbf{B}$$

where q is the value of the charge on a carrier. Now $nq \mathbf{v}_d$ is the current density \mathbf{j} and $|(nq \mathbf{v}_d)| A$ is the current I (see Chapter 3 for the discussion of current and current density). Thus,

$$\mathbf{F} = [(nq \mathbf{v}_d) l A] \times \mathbf{B} = [\mathbf{j} l A] \times \mathbf{B} = I \mathbf{l} \times \mathbf{B} \tag{4.4}$$

where \mathbf{l} is a vector of magnitude l , the length of the rod, and with a direction identical to the current I . Note that the current I is not a vector. In the last step leading to Eq. (4.4), we have transferred the vector sign from \mathbf{j} to \mathbf{l} .

Equation (4.4) holds for a straight rod. In this equation, \mathbf{B} is the external magnetic field. It is not the field produced by the current-carrying rod. If the wire has an arbitrary shape we can calculate the Lorentz force on it by considering it as a collection of linear strips $d\mathbf{l}_j$ and summing

$$\mathbf{F} = \sum_j I d\mathbf{l}_j \times \mathbf{B}$$

This summation can be converted to an integral in most cases.

Example 4.1 A straight wire of mass 200 g and length 1.5 m carries a current of 2 A. It is suspended in mid-air by a uniform horizontal magnetic field \mathbf{B} (Fig. 4.3). What is the magnitude of the magnetic field?

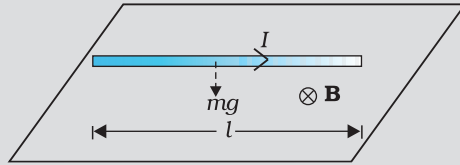

FIGURE 4.3

Solution From Eq. (4.4), we find that there is an upward force \mathbf{F} , of magnitude IlB . For mid-air suspension, this must be balanced by the force due to gravity:

$$mg = IlB$$

$$B = \frac{mg}{Il}$$

$$= \frac{0.2 \times 9.8}{2 \times 1.5} = 0.65 \text{ T}$$

Note that it would have been sufficient to specify m/l , the mass per unit length of the wire. The earth's magnetic field is approximately 4×10^{-5} T and we have ignored it.

Example 4.2 If the magnetic field is parallel to the positive y -axis and the charged particle is moving along the positive x -axis (Fig. 4.4), which way would the Lorentz force be for (a) an electron (negative charge), (b) a proton (positive charge).

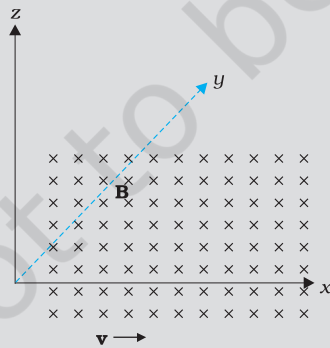

FIGURE 4.4

Solution The velocity \mathbf{v} of particle is along the x -axis, while \mathbf{B} , the magnetic field is along the y -axis, so $\mathbf{v} \times \mathbf{B}$ is along the z -axis (screw rule or right-hand thumb rule). So, (a) for electron it will be along $-z$ axis. (b) for a positive charge (proton) the force is along $+z$ axis.

PHYSICS

Charged particles moving in a magnetic field.
Interactive demonstration:
<http://www.phys.hawaii.edu/~teb/optics/java/partmagn/index.html>

EXAMPLE 4.1

EXAMPLE 4.2

4.3 MOTION IN A MAGNETIC FIELD

We will now consider, in greater detail, the motion of a charge moving in a magnetic field. We have learnt in Mechanics (see Class XI book, Chapter 5) that a force on a particle does work if the force has a component along (or opposed to) the direction of motion of the particle. In the case of motion of a charge in a magnetic field, the magnetic force is perpendicular to the velocity of the particle. So no work is done and no change in the magnitude of the velocity is produced (though the direction of momentum may be changed). [Notice that this is unlike the force due to an electric field, $q\mathbf{E}$, which *can* have a component parallel (or antiparallel) to motion and thus can transfer energy in addition to momentum.]

We shall consider motion of a charged particle in a *uniform* magnetic field. First consider the case of \mathbf{v} perpendicular to \mathbf{B} . The perpendicular force, $q\mathbf{v} \times \mathbf{B}$, acts as a centripetal force and produces a circular motion perpendicular to the magnetic field. *The particle will describe a circle if \mathbf{v} and \mathbf{B} are perpendicular to each other* (Fig. 4.5).

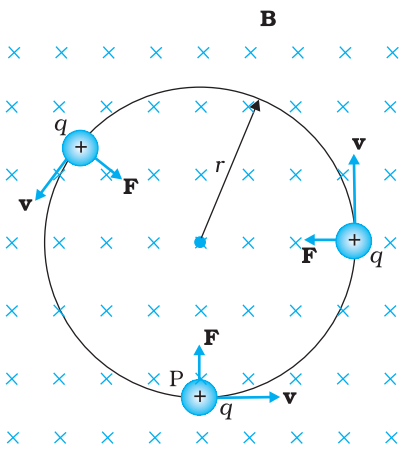

FIGURE 4.5 Circular motion

If velocity has a component along \mathbf{B} , this component remains unchanged as the motion along the magnetic field will not be affected by the magnetic field. The motion in a plane perpendicular to \mathbf{B} is as before a circular one, thereby producing a *helical motion* (Fig. 4.6).

You have already learnt in earlier classes (See Class XI, Chapter 3) that if r is the radius of the circular path of a particle, then a force of $m v^2 / r$, acts perpendicular to the path towards the centre of the circle, and is called the centripetal force. If the velocity \mathbf{v} is perpendicular to the magnetic field \mathbf{B} , the magnetic force is perpendicular to both \mathbf{v} and \mathbf{B} and acts like a centripetal force. It has a magnitude $q v B$. Equating the two expressions for centripetal force,

$$m v^2 / r = q v B, \text{ which gives}$$

$$r = m v / q B \tag{4.5}$$

for the radius of the circle described by the charged particle. The larger the momentum, the larger is the radius and bigger the circle described. If ω is the angular frequency, then $v = \omega r$. So,

$$\omega = 2\pi \nu = q B / m \tag{4.6(a)}$$

which is independent of the velocity or energy. Here ν is the frequency of rotation. The independence of ν from energy has important application in the design of a cyclotron (see Section 4.4.2).

The time taken for one revolution is $T = 2\pi / \omega = 1 / \nu$. If there is a component of the velocity parallel to the magnetic field (denoted by v_{\parallel}), it will make the particle

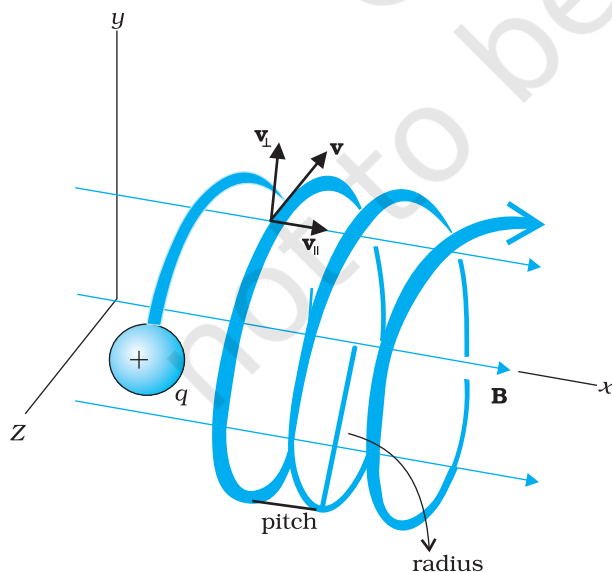

FIGURE 4.6 Helical motion

move along the field and the path of the particle would be a helical one (Fig. 4.6). The distance moved along the magnetic field in one rotation is called pitch p . Using Eq. [4.6 (a)], we have

$$p = v_{\parallel} T = 2\pi m v_{\parallel} / q B \quad [4.6(b)]$$

The radius of the circular component of motion is called the *radius* of the *helix*.

Example 4.3 What is the radius of the path of an electron (mass 9×10^{-31} kg and charge 1.6×10^{-19} C) moving at a speed of 3×10^7 m/s in a magnetic field of 6×10^{-4} T perpendicular to it? What is its frequency? Calculate its energy in keV. ($1 \text{ eV} = 1.6 \times 10^{-19}$ J).

Solution Using Eq. (4.5) we find

$$r = m v / (qB) = 9 \times 10^{-31} \text{ kg} \times 3 \times 10^7 \text{ m s}^{-1} / (1.6 \times 10^{-19} \text{ C} \times 6 \times 10^{-4} \text{ T}) \\ = 28 \times 10^{-2} \text{ m} = 28 \text{ cm}$$

$$f = v / (2 \pi r) = 17 \times 10^6 \text{ s}^{-1} = 17 \times 10^6 \text{ Hz} = 17 \text{ MHz.}$$

$$E = (\frac{1}{2}) m v^2 = (\frac{1}{2}) 9 \times 10^{-31} \text{ kg} \times 9 \times 10^{14} \text{ m}^2/\text{s}^2 = 40.5 \times 10^{-17} \text{ J} \\ \approx 4 \times 10^{-16} \text{ J} = 2.5 \text{ keV.}$$

EXAMPLE 4.3

4.4 MAGNETIC FIELD DUE TO A CURRENT ELEMENT, BIOT-SAVART LAW

All magnetic fields that we know are due to currents (or moving charges) and due to intrinsic magnetic moments of particles. Here, we shall study the relation between current and the magnetic field it produces. It is given by the Biot-Savart's law. Fig. 4.7 shows a finite conductor XY carrying current I . Consider an infinitesimal element $d\mathbf{l}$ of the conductor. The magnetic field $d\mathbf{B}$ due to this element is to be determined at a point P which is at a distance r from it. Let θ be the angle between $d\mathbf{l}$ and the displacement vector \mathbf{r} . According to Biot-Savart's law, the magnitude of the magnetic field $d\mathbf{B}$ is proportional to the current I , the element length $|d\mathbf{l}|$, and inversely proportional to the square of the distance r . Its direction* is perpendicular to the plane containing $d\mathbf{l}$ and \mathbf{r} . Thus, in vector notation,

$$d\mathbf{B} \propto \frac{I d\mathbf{l} \times \mathbf{r}}{r^3} \\ = \frac{\mu_0}{4\pi} \frac{I d\mathbf{l} \times \mathbf{r}}{r^3} \quad [4.7(a)]$$

where $\mu_0/4\pi$ is a constant of proportionality. The above expression holds when the medium is vacuum.

* The sense of $d\mathbf{l} \times \mathbf{r}$ is also given by the *Right Hand Screw rule* : Look at the plane containing vectors $d\mathbf{l}$ and \mathbf{r} . Imagine moving from the first vector towards second vector. If the movement is anticlockwise, the resultant is towards you. If it is clockwise, the resultant is away from you.

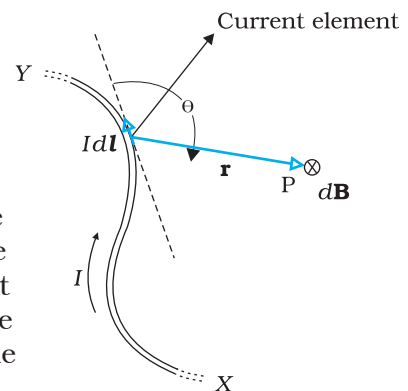

FIGURE 4.7 Illustration of the Biot-Savart law. The current element $I d\mathbf{l}$ produces a field $d\mathbf{B}$ at a distance r . The \otimes sign indicates that the field is perpendicular to the plane of this page and directed into it.

The magnitude of this field is,

$$|d\mathbf{B}| = \frac{\mu_0}{4\pi} \frac{I dl \sin \theta}{r^2} \quad [4.7(b)]$$

where we have used the property of cross-product. Equation [4.7 (a)] constitutes our basic equation for the magnetic field. The proportionality constant in SI units has the exact value,

$$\frac{\mu_0}{4\pi} = 10^{-7} \text{ Tm/A} \quad [4.7(c)]$$

We call μ_0 the *permeability* of free space (or vacuum).

The Biot-Savart law for the magnetic field has certain similarities, as well as, differences with the Coulomb's law for the electrostatic field. Some of these are:

- (i) Both are long range, since both depend inversely on the square of distance from the source to the point of interest. The principle of superposition applies to both fields. [In this connection, note that the magnetic field is *linear* in the *source* $I d\mathbf{l}$ just as the electrostatic field is linear in its source: the electric charge.]
- (ii) The electrostatic field is produced by a scalar source, namely, the electric charge. The magnetic field is produced by a vector source $I d\mathbf{l}$.
- (iii) The electrostatic field is along the displacement vector joining the source and the field point. The magnetic field is perpendicular to the plane containing the displacement vector \mathbf{r} and the current element $I d\mathbf{l}$.
- (iv) There is an angle dependence in the Biot-Savart law which is not present in the electrostatic case. In Fig. 4.7, the magnetic field at any point in the direction of $d\mathbf{l}$ (the dashed line) is zero. Along this line, $\theta = 0$, $\sin \theta = 0$ and from Eq. [4.7(a)], $|d\mathbf{B}| = 0$.

There is an interesting relation between ϵ_0 , the permittivity of free space; μ_0 , the permeability of free space; and c , the speed of light in vacuum:

$$\epsilon_0 \mu_0 = (4\pi \epsilon_0) \frac{\mu_0}{4\pi} = \frac{1}{9 \times 10^9} (10^{-7}) = \frac{1}{(3 \times 10^8)^2} = \frac{1}{c^2}$$

We will discuss this connection further in Chapter 8 on the electromagnetic waves. Since the speed of light in vacuum is constant, the product $\mu_0 \epsilon_0$ is fixed in magnitude. Choosing the value of either ϵ_0 or μ_0 , fixes the value of the other. In SI units, μ_0 is fixed to be equal to $4\pi \times 10^{-7}$ in magnitude.

EXAMPLE 4.4

Example 4.4 An element $\Delta \mathbf{l} = \Delta x \hat{\mathbf{i}}$ is placed at the origin and carries a large current $I = 10 \text{ A}$ (Fig. 4.8). What is the magnetic field on the y -axis at a distance of 0.5 m. $\Delta x = 1 \text{ cm}$.

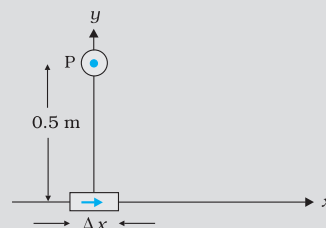

FIGURE 4.8

Solution

$$|d\mathbf{B}| = \frac{\mu_0}{4\pi} \frac{I dl \sin \theta}{r^2} \quad [\text{using Eq. (4.7)}]$$

$$dl = \Delta x = 10^{-2} \text{ m}, \quad I = 10 \text{ A}, \quad r = 0.5 \text{ m} = y, \quad \mu_0 / 4\pi = 10^{-7} \frac{\text{T m}}{\text{A}}$$

$$\theta = 90^\circ; \quad \sin \theta = 1$$

$$|d\mathbf{B}| = \frac{10^{-7} \times 10 \times 10^{-2}}{25 \times 10^{-2}} = 4 \times 10^{-8} \text{ T}$$

The direction of the field is in the $+z$ -direction. This is so since,

$$d\mathbf{l} \times \mathbf{r} = \Delta x \hat{\mathbf{i}} \times y \hat{\mathbf{j}} = y \Delta x (\hat{\mathbf{i}} \times \hat{\mathbf{j}}) = y \Delta x \hat{\mathbf{k}}$$

We remind you of the following cyclic property of cross-products,

$$\hat{\mathbf{i}} \times \hat{\mathbf{j}} = \hat{\mathbf{k}}; \quad \hat{\mathbf{j}} \times \hat{\mathbf{k}} = \hat{\mathbf{i}}; \quad \hat{\mathbf{k}} \times \hat{\mathbf{i}} = \hat{\mathbf{j}}$$

Note that the field is small in magnitude.

EXAMPLE 4.4

In the next section, we shall use the Biot-Savart law to calculate the magnetic field due to a circular loop.

4.5 MAGNETIC FIELD ON THE AXIS OF A CIRCULAR CURRENT LOOP

In this section, we shall evaluate the magnetic field due to a circular coil along its axis. The evaluation entails summing up the effect of infinitesimal current elements ($I dl$) mentioned in the previous section. We assume that the current I is steady and that the evaluation is carried out in free space (i.e., vacuum).

Fig. 4.9 depicts a circular loop carrying a steady current I . The loop is placed in the y - z plane with its centre at the origin O and has a radius R . The x -axis is the axis of the loop. We wish to calculate the magnetic field at the point P on this axis. Let x be the distance of P from the centre O of the loop.

Consider a conducting element $d\mathbf{l}$ of the loop. This is shown in Fig. 4.9. The magnitude dB of the magnetic field due to $d\mathbf{l}$ is given by the Biot-Savart law [Eq. 4.7(a)],

$$dB = \frac{\mu_0}{4\pi} \frac{I |d\mathbf{l} \times \mathbf{r}|}{r^3} \quad (4.8)$$

Now $r^2 = x^2 + R^2$. Further, any element of the loop will be perpendicular to the displacement vector from the element to the axial point. For example, the element $d\mathbf{l}$ in Fig. 4.9 is in the y - z plane, whereas, the displacement vector \mathbf{r} from $d\mathbf{l}$ to the axial point P is in the x - y plane. Hence $|d\mathbf{l} \times \mathbf{r}| = r dl$. Thus,

$$dB = \frac{\mu_0}{4\pi} \frac{I dl}{(x^2 + R^2)} \quad (4.9)$$

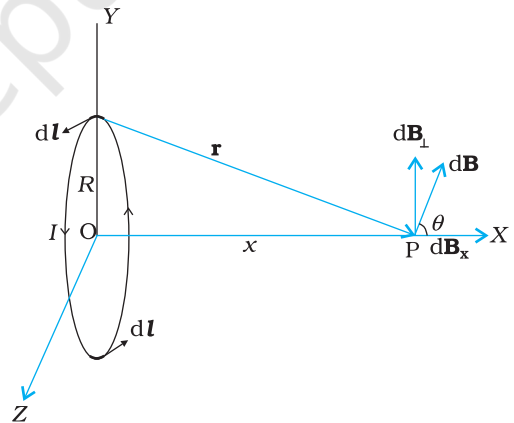

FIGURE 4.9 Magnetic field on the axis of a current carrying circular loop of radius R . Shown are the magnetic field $d\mathbf{B}$ (due to a line element $d\mathbf{l}$) and its components along and perpendicular to the axis.

The direction of $d\mathbf{B}$ is shown in Fig. 4.9. It is perpendicular to the plane formed by $d\mathbf{l}$ and \mathbf{r} . It has an x -component dB_x and a component perpendicular to x -axis, dB_{\perp} . When the components perpendicular to the x -axis are summed over, they cancel out and we obtain a null result. For example, the dB_{\perp} component due to $d\mathbf{l}$ is cancelled by the contribution due to the diametrically opposite $d\mathbf{l}$ element, shown in Fig. 4.9. Thus, only the x -component survives. The net contribution along x -direction can be obtained by integrating $dB_x = dB \cos \theta$ over the loop. For Fig. 4.9,

$$\cos \theta = \frac{R}{(x^2 + R^2)^{1/2}} \quad (4.10)$$

From Eqs. (4.9) and (4.10),

$$dB_x = \frac{\mu_0 I dl}{4\pi} \frac{R}{(x^2 + R^2)^{3/2}}$$

The summation of elements dl over the loop yields $2\pi R$, the circumference of the loop. Thus, the magnetic field at P due to entire circular loop is

$$\mathbf{B} = B_x \hat{\mathbf{i}} = \frac{\mu_0 I R^2}{2(x^2 + R^2)^{3/2}} \hat{\mathbf{i}} \quad (4.11)$$

As a special case of the above result, we may obtain the field at the centre of the loop. Here $x = 0$, and we obtain,

$$\mathbf{B}_0 = \frac{\mu_0 I}{2R} \hat{\mathbf{i}} \quad (4.12)$$

The magnetic field lines due to a circular wire form closed loops and are shown in Fig. 4.10. The direction of the magnetic field is given by (another) *right-hand thumb rule* stated below:

Curl the palm of your right hand around the circular wire with the fingers pointing in the direction of the current. The right-hand thumb gives the direction of the magnetic field.

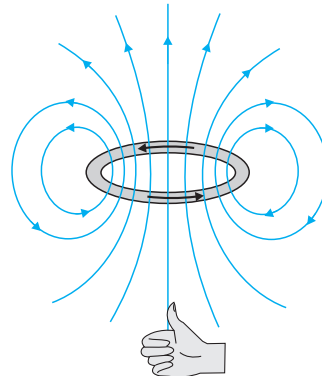

FIGURE 4.10 The magnetic field lines for a current loop. The direction of the field is given by the right-hand thumb rule described in the text. The upper side of the loop may be thought of as the north pole and the lower side as the south pole of a magnet.

Example 4.5 A straight wire carrying a current of 12 A is bent into a semi-circular arc of radius 2.0 cm as shown in Fig. 4.11(a). Consider the magnetic field \mathbf{B} at the centre of the arc. (a) What is the magnetic field due to the straight segments? (b) In what way the contribution to \mathbf{B} from the semicircle differs from that of a circular loop and in what way does it resemble? (c) Would your answer be different if the wire were bent into a semi-circular arc of the same radius but in the opposite way as shown in Fig. 4.11(b)?

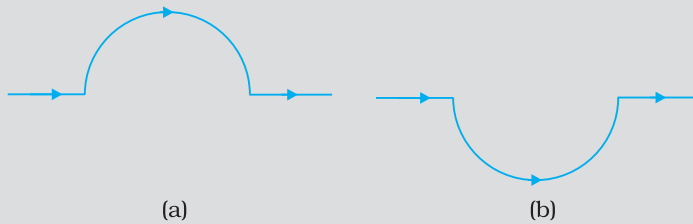

FIGURE 4.11

Solution

- (a) $d\mathbf{l}$ and \mathbf{r} for each element of the straight segments are parallel. Therefore, $d\mathbf{l} \times \mathbf{r} = 0$. Straight segments do not contribute to $|\mathbf{B}|$.
- (b) For all segments of the semicircular arc, $d\mathbf{l} \times \mathbf{r}$ are all parallel to each other (into the plane of the paper). All such contributions add up in magnitude. Hence direction of \mathbf{B} for a semicircular arc is given by the right-hand rule and magnitude is half that of a circular loop. Thus \mathbf{B} is 1.9×10^{-4} T normal to the plane of the paper going into it.
- (c) Same magnitude of \mathbf{B} but opposite in direction to that in (b).

EXAMPLE 4.5

Example 4.6 Consider a tightly wound 100 turn coil of radius 10 cm, carrying a current of 1 A. What is the magnitude of the magnetic field at the centre of the coil?

Solution Since the coil is tightly wound, we may take each circular element to have the same radius $R = 10$ cm = 0.1 m. The number of turns $N = 100$. The magnitude of the magnetic field is,

$$B = \frac{\mu_0 NI}{2R} = \frac{4\pi \times 10^{-7} \times 10^2 \times 1}{2 \times 10^{-1}} = 2\pi \times 10^{-4} = 6.28 \times 10^{-4} \text{ T}$$

EXAMPLE 4.6

4.6 AMPERE'S CIRCUITAL LAW

There is an alternative and appealing way in which the Biot-Savart law may be expressed. Ampere's circuital law considers an open surface with a boundary (Fig. 4.12). The surface has current passing through it. We consider the boundary to be made up of a number of small line elements. Consider one such element of length $d\mathbf{l}$. We take the value of the tangential component of the magnetic field, B_t , at this element and multiply it by the

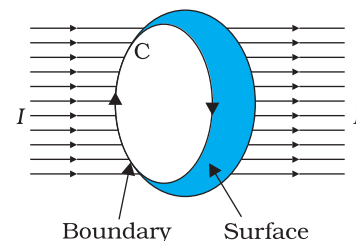

FIGURE 4.12



Andre Ampere (1775 – 1836) Andre Marie Ampere was a French physicist, mathematician and chemist who founded the science of electrodynamics. Ampere was a child prodigy who mastered advanced mathematics by the age of 12. Ampere grasped the significance of Oersted's discovery. He carried out a large series of experiments to explore the relationship between current electricity and magnetism. These investigations culminated in 1827 with the publication of the 'Mathematical Theory of Electrodynamical Phenomena Deduced Solely from Experiments'. He hypothesised that *all* magnetic phenomena are due to circulating electric currents. Ampere was humble and absent-minded. He once forgot an invitation to dine with the Emperor Napoleon. He died of pneumonia at the age of 61. His gravestone bears the epitaph: *Tandem Felix* (Happy at last).

ANDRE AMPERE (1775 – 1836)

length of that element dl [Note: $B_t dl = \mathbf{B} \cdot d\mathbf{l}$]. All such products are added together. We consider the limit as the lengths of elements get smaller and their number gets larger. The sum then tends to an integral. Ampere's law states that this integral is equal to μ_0 times the total current passing through the surface, i.e.,

$$\oint \mathbf{B} \cdot d\mathbf{l} = \mu_0 I \quad [4.13(a)]$$

where I is the total current through the surface. The integral is taken over the closed loop coinciding with the boundary C of the surface. The relation above involves a sign-convention, given by the right-hand rule. Let the fingers of the right-hand be curled in the sense the boundary is traversed in the loop integral $\oint \mathbf{B} \cdot d\mathbf{l}$. Then the direction of the thumb gives the sense in which the current I is regarded as positive.

For several applications, a much simplified version of Eq. [4.13(a)] proves sufficient. We shall assume that, in such cases, it is possible to choose the loop (called an *amperian loop*) such that at each point of the loop, *either*

- (i) \mathbf{B} is tangential to the loop and is a non-zero *constant* B , *or*
- (ii) \mathbf{B} is normal to the loop, *or*
- (iii) \mathbf{B} vanishes.

Now, let L be the length (part) of the loop for which \mathbf{B} is tangential. Let I_e be the current enclosed by the loop. Then, Eq. (4.13) reduces to,

$$BL = \mu_0 I_e \quad [4.13(b)]$$

When there is a system with a symmetry such as for a *straight infinite current-carrying wire* in Fig. 4.13, the Ampere's law enables an easy evaluation of the magnetic field, much the same way Gauss' law helps in determination of the electric field. This is exhibited in the Example 4.8 below. The boundary of the loop chosen is a circle and magnetic field is tangential to the circumference of the circle. The law gives, for the left hand side of Eq. [4.13 (b)], $B \cdot 2\pi r$. We find that the magnetic field at a distance r outside the wire is *tangential* and given by

$$B \times 2\pi r = \mu_0 I, \quad B = \mu_0 I / (2\pi r) \quad (4.14)$$

The above result for the infinite wire is interesting from several points of view.

- (i) It implies that the field at every point on a circle of radius r , (with the wire along the axis), is same in magnitude. In other words, the magnetic field

possesses what is called a *cylindrical symmetry*. The field that normally can depend on three coordinates depends only on one: r . Whenever there is symmetry, the solutions simplify.

- (ii) The field direction at any point on this circle is tangential to it. Thus, the lines of constant magnitude of magnetic field form concentric circles. Notice now, in Fig. 4.1(c), the iron filings form concentric circles. These lines called *magnetic field lines* form closed loops. This is unlike the electrostatic field lines which originate from positive charges and end at negative charges. The expression for the magnetic field of a straight wire provides a theoretical justification to Oersted's experiments.
- (iii) Another interesting point to note is that even though the wire is infinite, the field due to it at a non-zero distance is *not* infinite. It tends to blow up only when we come very close to the wire. The field is directly proportional to the current and inversely proportional to the distance from the (infinitely long) current source.
- (iv) There exists a simple rule to determine the direction of the magnetic field due to a long wire. This rule, called the *right-hand rule**, is:

Grasp the wire in your right hand with your extended thumb pointing in the direction of the current. Your fingers will curl around in the direction of the magnetic field.

Ampere's circuital law is not new in content from Biot-Savart law. Both relate the magnetic field and the current, and both express the same physical consequences of a steady electrical current. Ampere's law is to Biot-Savart law, what Gauss's law is to Coulomb's law. Both, Ampere's and Gauss's law relate a physical quantity on the periphery or boundary (magnetic or electric field) to another physical quantity, namely, the source, in the interior (current or charge). We also note that Ampere's circuital law holds for steady currents which do not fluctuate with time. The following example will help us understand what is meant by the term *enclosed current*.

Example 4.7 Figure 4.13 shows a long straight wire of a circular cross-section (radius a) carrying steady current I . The current I is uniformly distributed across this cross-section. Calculate the magnetic field in the region $r < a$ and $r > a$.

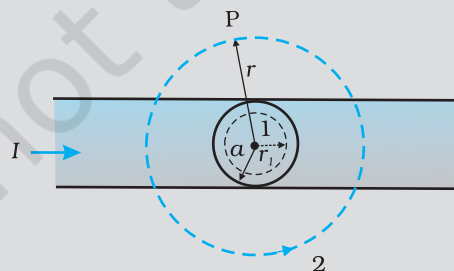

FIGURE 4.13

EXAMPLE 4.7

* Note that there are *two distinct* right-hand rules: One which gives the direction of \mathbf{B} on the axis of current-loop and the other which gives direction of \mathbf{B} for a straight conducting wire. Fingers and thumb play different roles in the two.

Solution (a) Consider the case $r > a$. The Amperian loop, labelled 2, is a circle concentric with the cross-section. For this loop,

$$L = 2\pi r$$

$$I_e = \text{Current enclosed by the loop} = I$$

The result is the familiar expression for a long straight wire

$$B(2\pi r) = \mu_0 I$$

$$B = \frac{\mu_0 I}{2\pi r} \quad [4.15(a)]$$

$$B \propto \frac{1}{r} \quad (r > a)$$

Now the current enclosed I_e is not I , but is less than this value. Since the current distribution is uniform, the current enclosed is,

$$I_e = I \left(\frac{\pi r^2}{\pi a^2} \right) = \frac{I r^2}{a^2}$$

$$\text{Using Ampere's law, } B(2\pi r) = \mu_0 \frac{I r^2}{a^2}$$

$$B = \left(\frac{\mu_0 I}{2\pi a^2} \right) r \quad [4.15(b)]$$

$$B \propto r \quad (r < a)$$

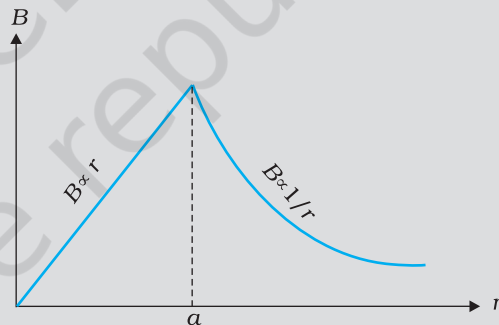

FIGURE 4.14

Figure (4.14) shows a plot of the magnitude of \mathbf{B} with distance r from the centre of the wire. The direction of the field is tangential to the respective circular loop (1 or 2) and given by the right-hand rule described earlier in this section.

This example possesses the required symmetry so that Ampere's law can be applied readily.

EXAMPLE 4.7

It should be noted that while Ampere's circuital law holds for any loop, it may not always facilitate an evaluation of the magnetic field in every case. For example, for the case of the circular loop discussed in Section 4.5, it cannot be applied to extract the simple expression $B = \mu_0 I / 2R$ [Eq. (4.12)] for the field at the centre of the loop. However, there exists a large number of situations of high symmetry where the law can be conveniently applied. We shall use it in the next section to calculate

the magnetic field produced by two commonly used and very useful magnetic systems: the *solenoid* and the *toroid*.

4.7 THE SOLENOID

We shall discuss a long solenoid. By long solenoid we mean that the solenoid's length is large compared to its radius. It consists of a long wire wound in the form of a helix where the neighbouring turns are closely spaced. So each turn can be regarded as a circular loop. The net magnetic field is the vector sum of the fields due to all the turns. Enamelled wires are used for winding so that turns are insulated from each other.

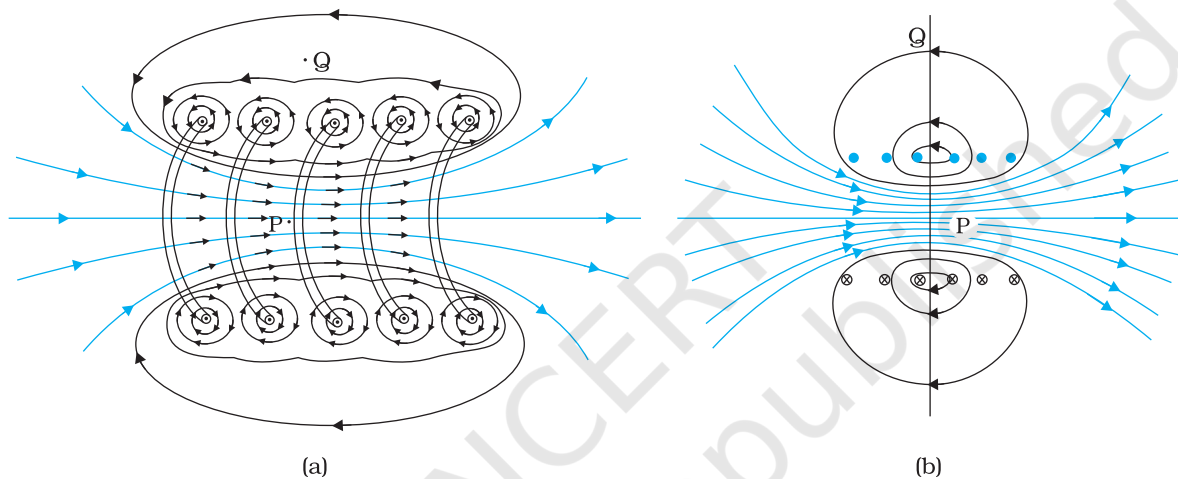

FIGURE 4.15 (a) The magnetic field due to a section of the solenoid which has been stretched out for clarity. Only the exterior semi-circular part is shown. Notice how the circular loops between neighbouring turns tend to cancel. (b) The magnetic field of a finite solenoid.

Figure 4.15 displays the magnetic field lines for a finite solenoid. We show a section of this solenoid in an enlarged manner in Fig. 4.15(a). Figure 4.15(b) shows the entire finite solenoid with its magnetic field. In Fig. 4.15(a), it is clear from the circular loops that the field between two neighbouring turns vanishes. In Fig. 4.15(b), we see that the field at the interior mid-point P is uniform, strong and along the axis of the solenoid. The field at the exterior mid-point Q is weak and moreover is along the axis of the solenoid with no perpendicular or normal component. As the

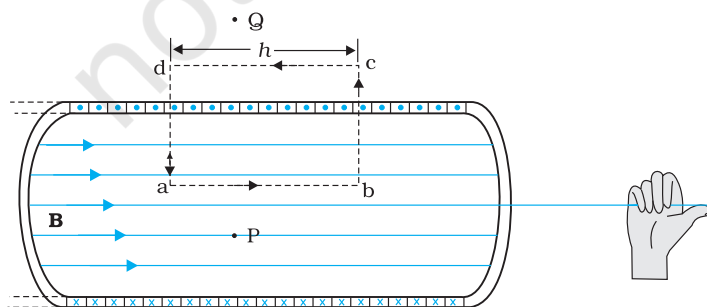

FIGURE 4.16 The magnetic field of a very long solenoid. We consider a rectangular Amperian loop abcd to determine the field.

solenoid is made longer it appears like a long cylindrical metal sheet. Figure 4.16 represents this idealised picture. The field outside the solenoid approaches zero. We shall assume that the field outside is zero. The field inside becomes everywhere parallel to the axis.

Consider a rectangular Amperian loop $abcd$. Along cd the field is zero as argued above. Along transverse sections bc and ad , the field component is zero. Thus, these two sections make no contribution. Let the field along ab be B . Thus, the relevant length of the Amperian loop is, $L = h$.

Let n be the number of turns per unit length, then the total number of turns is nh . The enclosed current is, $I_e = I(nh)$, where I is the current in the solenoid. From Ampere's circuital law [Eq. 4.13 (b)]

$$BL = \mu_0 I_e, \quad Bh = \mu_0 I(nh)$$

$$B = \mu_0 n I \quad (4.16)$$

The direction of the field is given by the right-hand rule. The solenoid is commonly used to obtain a uniform magnetic field. We shall see in the next chapter that a large field is possible by inserting a soft iron core inside the solenoid.

EXAMPLE 4.8

Example 4.8 A solenoid of length 0.5 m has a radius of 1 cm and is made up of 500 turns. It carries a current of 5 A. What is the magnitude of the magnetic field inside the solenoid?

Solution The number of turns per unit length is,

$$n = \frac{500}{0.5} = 1000 \text{ turns/m}$$

The length $l = 0.5$ m and radius $r = 0.01$ m. Thus, $l/a = 50$ i.e., $l \gg a$. Hence, we can use the *long* solenoid formula, namely, Eq. (4.20)

$$B = \mu_0 n I$$

$$= 4\pi \times 10^{-7} \times 10^3 \times 5$$

$$= 6.28 \times 10^{-3} \text{ T}$$

4.8 FORCE BETWEEN TWO PARALLEL CURRENTS, THE AMPERE

We have learnt that there exists a magnetic field due to a conductor carrying a current which obeys the Biot-Savart law. Further, we have learnt that an external magnetic field will exert a force on a current-carrying conductor. This follows from the Lorentz force formula. Thus, it is logical to expect that two current-carrying conductors placed near each other will exert (magnetic) forces on each other. In the period 1820-25, Ampere studied the nature of this magnetic force and its dependence on the magnitude of the current, on the shape and size of the conductors, as well as, the distances between the conductors. In this section, we shall take the simple example of two parallel current-carrying conductors, which will perhaps help us to appreciate Ampere's painstaking work.

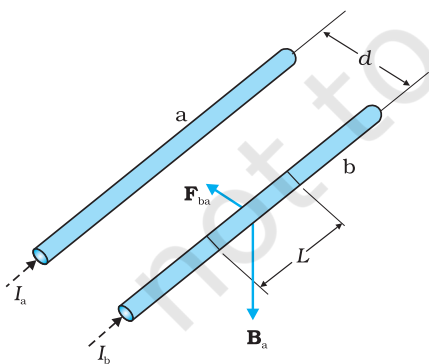

FIGURE 4.17 Two long straight parallel conductors carrying steady currents I_a and I_b and separated by a distance d . \mathbf{B}_a is the magnetic field set up by conductor 'a' at conductor 'b'.

Figure 4.17 shows two long parallel conductors a and b separated by a distance d and carrying (parallel) currents I_a and I_b , respectively. The conductor 'a' produces, the same magnetic field \mathbf{B}_a at all points along the conductor 'b'. The right-hand rule tells us that the direction of this field is downwards (when the conductors are placed horizontally). Its magnitude is given by Eq. [4.15(a)] or from Ampere's circuital law,

$$B_a = \frac{\mu_0 I_a}{2\pi d}$$

The conductor 'b' carrying a current I_b will experience a sideways force due to the field \mathbf{B}_a . The direction of this force is towards the conductor 'a' (Verify this). We label this force as \mathbf{F}_{ba} , the force on a segment L of 'b' due to 'a'. The magnitude of this force is given by Eq. (4.4),

$$\begin{aligned} F_{ba} &= I_b L B_a \\ &= \frac{\mu_0 I_a I_b}{2\pi d} L \end{aligned} \quad (4.17)$$

It is of course possible to compute the force on 'a' due to 'b'. From considerations similar to above we can find the force \mathbf{F}_{ab} , on a segment of length L of 'a' due to the current in 'b'. It is equal in magnitude to F_{ba} , and directed towards 'b'. Thus,

$$\mathbf{F}_{ba} = -\mathbf{F}_{ab} \quad (4.18)$$

Note that this is consistent with Newton's third Law. Thus, at least for parallel conductors and steady currents, we have shown that the Biot-Savart law and the Lorentz force yield results in accordance with Newton's third Law*.

We have seen from above that currents flowing in the same direction attract each other. One can show that oppositely directed currents repel each other. Thus,

Parallel currents attract, and antiparallel currents repel.

This rule is the opposite of what we find in electrostatics. Like (same sign) charges repel each other, but like (parallel) currents attract each other.

Let f_{ba} represent the magnitude of the force \mathbf{F}_{ba} per unit length. Then, from Eq. (4.17),

$$f_{ba} = \frac{\mu_0 I_a I_b}{2\pi d} \quad (4.19)$$

The above expression is used to define the ampere (A), which is one of the seven SI base units.

* It turns out that when we have time-dependent currents and/or charges in motion, Newton's third law may not hold for forces between charges and/or conductors. An essential consequence of the Newton's third law in mechanics is conservation of momentum of an isolated system. This, however, holds even for the case of time-dependent situations with electromagnetic fields, provided the momentum carried by fields is also taken into account.

The *ampere* is the value of that steady current which, when maintained in each of the two very long, straight, parallel conductors of negligible cross-section, and placed one metre apart in vacuum, would produce on each of these conductors a force equal to 2×10^{-7} newtons per metre of length.

This definition of the ampere was adopted in 1946. It is a theoretical definition. In practice, one must eliminate the effect of the earth's magnetic field and substitute very long wires by multiturn coils of appropriate geometries. An instrument called the current balance is used to measure this mechanical force.

The SI unit of charge, namely, the coulomb, can now be defined in terms of the ampere.

When a steady current of 1A is set up in a conductor, the quantity of charge that flows through its cross-section in 1s is one coulomb (1C).

Example 4.9 The horizontal component of the earth's magnetic field at a certain place is 3.0×10^{-5} T and the direction of the field is from the geographic south to the geographic north. A very long straight conductor is carrying a steady current of 1A. What is the force per unit length on it when it is placed on a horizontal table and the direction of the current is (a) east to west; (b) south to north?

Solution $\mathbf{F} = I\mathbf{l} \times \mathbf{B}$

$$F = IlB \sin\theta$$

The force per unit length is

$$f = F/l = IB \sin\theta$$

(a) When the current is flowing from east to west,

$$\theta = 90^\circ$$

Hence,

$$f = IB$$

$$= 1 \times 3 \times 10^{-5} = 3 \times 10^{-5} \text{ N m}^{-1}$$

This is larger than the value $2 \times 10^{-7} \text{ Nm}^{-1}$ quoted in the definition of the ampere. Hence it is important to eliminate the effect of the earth's magnetic field and other stray fields while standardising the ampere.

The direction of the force is downwards. This direction may be obtained by the directional property of cross product of vectors.

(b) When the current is flowing from south to north,

$$\theta = 0^\circ$$

$$f = 0$$

Hence there is no force on the conductor.

4.9 TORQUE ON CURRENT LOOP, MAGNETIC DIPOLE

4.9.1 Torque on a rectangular current loop in a uniform magnetic field

We now show that a rectangular loop carrying a steady current I and placed in a uniform magnetic field experiences a torque. It does not experience a net force. This behaviour is analogous to that of electric dipole in a uniform electric field (Section 1.11).

We first consider the simple case when the rectangular loop is placed such that the uniform magnetic field \mathbf{B} is in the plane of the loop. This is illustrated in Fig. 4.18(a).

The field exerts no force on the two arms AD and BC of the loop. It is perpendicular to the arm AB of the loop and exerts a force \mathbf{F}_1 on it which is directed into the plane of the loop. Its magnitude is,

$$F_1 = I b B$$

Similarly, it exerts a force \mathbf{F}_2 on the arm CD and \mathbf{F}_2 is directed out of the plane of the paper.

$$F_2 = I b B = F_1$$

Thus, the *net force* on the loop is zero. There is a torque on the loop due to the pair of forces \mathbf{F}_1 and \mathbf{F}_2 . Figure 4.18(b) shows a view of the loop from the AD end. It shows that the torque on the loop tends to rotate it anticlockwise. This torque is (in magnitude),

$$\begin{aligned} \tau &= F_1 \frac{a}{2} + F_2 \frac{a}{2} \\ &= I b B \frac{a}{2} + I b B \frac{a}{2} = I(ab)B \\ &= I A B \end{aligned} \quad (4.20)$$

where $A = ab$ is the area of the rectangle.

We next consider the case when the plane of the loop, is not along the magnetic field, but makes an angle with it. We take the angle between the field and the normal to the coil to be angle θ (The previous case corresponds to $\theta = \pi/2$). Figure 4.19 illustrates this general case.

The forces on the arms BC and DA are equal, opposite, and act along the axis of the coil, which connects the centres of mass of BC and DA. Being collinear along the axis they cancel each other, resulting in no net force or torque. The forces on arms AB and CD are \mathbf{F}_1 and \mathbf{F}_2 . They too are equal and opposite, with magnitude,

$$F_1 = F_2 = I b B$$

But they are not collinear! This results in a couple as before. The torque is, however, less than the earlier case when plane of loop was along the magnetic field. This is because the perpendicular distance between the forces of the couple has decreased. Figure 4.19(b) is a view of the arrangement from the AD end and it illustrates these two forces constituting a couple. The magnitude of the torque on the loop is,

$$\begin{aligned} \tau &= F_1 \frac{a}{2} \sin \theta + F_2 \frac{a}{2} \sin \theta \\ &= I a b B \sin \theta \\ &= I A B \sin \theta \end{aligned} \quad (4.21)$$

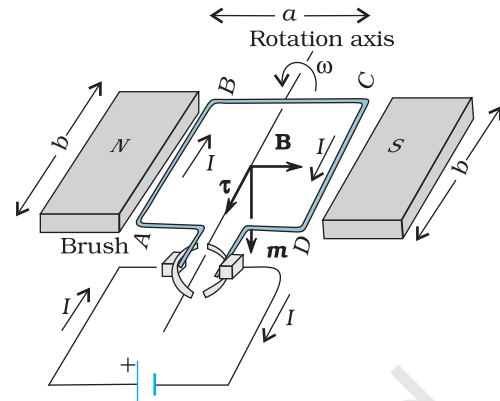

(a)

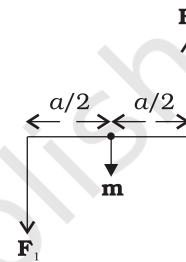

(b)

FIGURE 4.18 (a) A rectangular current-carrying coil in uniform magnetic field. The magnetic moment \mathbf{m} points downwards. The torque τ is along the axis and tends to rotate the coil anticlockwise. (b) The couple acting on the coil.

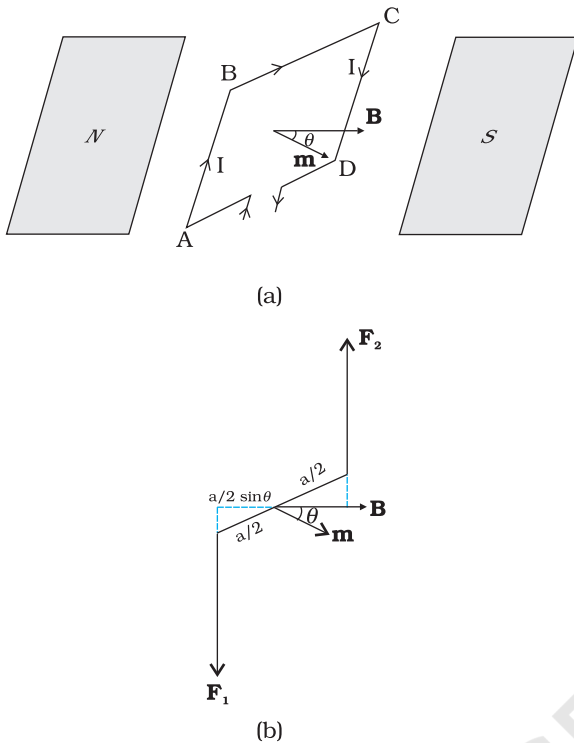

FIGURE 4.19 (a) The area vector of the loop ABCD makes an arbitrary angle θ with the magnetic field. (b) Top view of the loop. The forces F_1 and F_2 acting on the arms AB and CD are indicated.

As $\theta \rightarrow 0$, the perpendicular distance between the forces of the couple also approaches zero. This makes the forces collinear and the net force and torque zero. The torques in Eqs. (4.20) and (4.21) can be expressed as vector product of the magnetic moment of the coil and the magnetic field. We define the *magnetic moment* of the current loop as,

$$\mathbf{m} = I \mathbf{A} \quad (4.22)$$

where the direction of the area vector \mathbf{A} is given by the right-hand thumb rule and is directed into the plane of the paper in Fig. 4.18. Then as the angle between \mathbf{m} and \mathbf{B} is θ , Eqs. (4.20) and (4.21) can be expressed by one expression

$$\boldsymbol{\tau} = \mathbf{m} \times \mathbf{B} \quad (4.23)$$

This is analogous to the electrostatic case (Electric dipole of dipole moment \mathbf{p}_e in an electric field \mathbf{E}).

$$\boldsymbol{\tau} = \mathbf{p}_e \times \mathbf{E}$$

As is clear from Eq. (4.22), the dimensions of the magnetic moment are $[A][L^2]$ and its unit is Am^2 .

From Eq. (4.23), we see that the torque $\boldsymbol{\tau}$ vanishes when \mathbf{m} is either parallel or antiparallel to the magnetic field \mathbf{B} . This indicates a state of equilibrium as there is no torque on the coil (this also applies to any object with a magnetic moment \mathbf{m}). When \mathbf{m} and \mathbf{B} are parallel the equilibrium is a stable one. Any small rotation of the coil produces a torque which brings it back to its original position. When they are antiparallel, the equilibrium is unstable as any rotation produces a torque which increases with the amount of rotation. The presence of this torque is also the reason why a small magnet or any magnetic dipole aligns itself with the external magnetic field.

If the loop has N closely wound turns, the expression for torque, Eq. (4.23), still holds, with

$$\mathbf{m} = N I \mathbf{A} \quad (4.24)$$

EXAMPLE 4.10

Example 4.10 A 100 turn closely wound circular coil of radius 10 cm carries a current of 3.2 A. (a) What is the field at the centre of the coil? (b) What is the magnetic moment of this coil?

The coil is placed in a vertical plane and is free to rotate about a horizontal axis which coincides with its diameter. A uniform magnetic field of 2T in the horizontal direction exists such that initially the axis of the coil is in the direction of the field. The coil rotates through an angle of 90° under the influence of the magnetic field. (c) What are the magnitudes of the torques on the coil in the initial and final position? (d) What is the angular speed acquired by the coil when it has rotated by 90° ? The moment of inertia of the coil is 0.1 kg m^2 .

Solution

(a) From Eq. (4.12)

$$B = \frac{\mu_0 NI}{2R}$$

Here, $N = 100$; $I = 3.2$ A, and $R = 0.1$ m. Hence,

$$B = \frac{4\pi \times 10^{-7} \times 3.2}{2 \times 10^{-1}} = \frac{4 \times 10^{-5} \times 10}{2 \times 10^{-1}} \quad (\text{using } \pi \times 3.2 = 10)$$

$$= 2 \times 10^{-3} \text{ T}$$

The direction is given by the right-hand thumb rule.

(b) The magnetic moment is given by Eq. (4.24),

$$m = NIA = NI\pi r^2 = 100 \times 3.2 \times 3.14 \times 10^{-2} = 10 \text{ A m}^2$$

The direction is once again given by the right-hand thumb rule.

(c) $\tau = |\mathbf{m} \times \mathbf{B}|$ [from Eq. (4.23)]

$$= mB \sin \theta$$

Initially, $\theta = 0$. Thus, initial torque $\tau_i = 0$. Finally, $\theta = \pi/2$ (or 90°).

Thus, final torque $\tau_f = mB = 10 \times 2 = 20$ N m.

(d) From Newton's second law,

$$I \frac{d\omega}{dt} = mB \sin \theta$$

where I is the moment of inertia of the coil. From chain rule,

$$\frac{d\omega}{dt} = \frac{d\omega}{d\theta} \frac{d\theta}{dt} = \frac{d\omega}{d\theta} \omega$$

Using this,

$$I \omega d\omega = mB \sin \theta d\theta$$

Integrating from $\theta = 0$ to $\theta = \pi/2$,

$$I \int_0^{\omega_f} \omega d\omega = mB \int_0^{\pi/2} \sin \theta d\theta$$

$$I \frac{\omega_f^2}{2} = -mB \cos \theta \Big|_0^{\pi/2} = mB$$

$$\omega_f = \left(\frac{2mB}{I} \right)^{1/2} = \left(\frac{2 \times 20}{10^{-1}} \right)^{1/2} = 20 \text{ s}^{-1}$$

EXAMPLE 4.10

Example 4.11

- (a) A current-carrying circular loop lies on a smooth horizontal plane. Can a uniform magnetic field be set up in such a manner that the loop turns around itself (i.e., turns about the vertical axis).
- (b) A current-carrying circular loop is located in a uniform external magnetic field. If the loop is free to turn, what is its orientation of stable equilibrium? Show that in this orientation, the flux of

EXAMPLE 4.11

the total field (external field + field produced by the loop) is maximum.

- (c) A loop of irregular shape carrying current is located in an external magnetic field. If the wire is flexible, why does it change to a circular shape?

Solution

- (a) No, because that would require τ to be in the vertical direction. But $\tau = I \mathbf{A} \times \mathbf{B}$, and since \mathbf{A} of the horizontal loop is in the vertical direction, τ would be in the plane of the loop for any \mathbf{B} .
- (b) Orientation of stable equilibrium is one where the area vector \mathbf{A} of the loop is in the direction of external magnetic field. In this orientation, the magnetic field produced by the loop is in the same direction as external field, both normal to the plane of the loop, thus giving rise to maximum flux of the total field.
- (c) It assumes circular shape with its plane normal to the field to maximise flux, since for a given perimeter, a circle encloses greater area than any other shape.

4.9.2 Circular current loop as a magnetic dipole

In this section, we shall consider the elementary magnetic element: the current loop. We shall show that the magnetic field (at large distances) due to current in a circular current loop is very similar in behaviour to the electric field of an electric dipole. In Section 4.5, we have evaluated the magnetic field on the axis of a circular loop, of a radius R , carrying a steady current I . The magnitude of this field is [(Eq. (4.11)],

$$B = \frac{\mu_0 I R^2}{2(x^2 + R^2)^{3/2}}$$

and its direction is along the axis and given by the right-hand thumb rule (Fig. 4.10). Here, x is the distance along the axis from the centre of the loop. For $x \gg R$, we may drop the R^2 term in the denominator. Thus,

$$B = \frac{\mu_0 I R^2}{2x^3}$$

Note that the area of the loop $A = \pi R^2$. Thus,

$$B = \frac{\mu_0 I A}{2\pi x^3}$$

As earlier, we define the magnetic moment \mathbf{m} to have a magnitude IA , $\mathbf{m} = IA$. Hence,

$$\begin{aligned} B &\approx \frac{\mu_0 m}{2\pi x^3} \\ &= \frac{\mu_0}{4\pi} \frac{2\mathbf{m}}{x^3} \end{aligned} \tag{4.25(a)}$$

The expression of Eq. [4.25(a)] is very similar to an expression obtained earlier for the electric field of a dipole. The similarity may be seen if we substitute,

$$\mu_0 \rightarrow 1/\epsilon_0$$

$\mathbf{m} \rightarrow \mathbf{p}_e$ (electrostatic dipole)

$\mathbf{B} \rightarrow \mathbf{E}$ (electrostatic field)

We then obtain,

$$\mathbf{E} = \frac{2\mathbf{p}_e}{4\pi\epsilon_0 x^3}$$

which is precisely the field for an electric dipole at a point on its axis. considered in Chapter 1, Section 1.9 [Eq. (1.20)].

It can be shown that the above analogy can be carried further. We had found in Chapter 1 that the electric field on the perpendicular bisector of the dipole is given by [See Eq.(1.21)],

$$E = \frac{\mathbf{p}_e}{4\pi\epsilon_0 x^3}$$

where x is the distance from the dipole. If we replace $\mathbf{p} \rightarrow \mathbf{m}$ and $\mu_0 \rightarrow 1/\epsilon_0$ in the above expression, we obtain the result for \mathbf{B} for a point *in the plane of the loop* at a distance x from the centre. For $x \gg R$,

$$\mathbf{B} \approx \frac{\mu_0}{4\pi} \frac{\mathbf{m}}{x^3}; \quad x \gg R \quad [4.25(b)]$$

The results given by Eqs. [4.25(a)] and [4.25(b)] become exact for a *point magnetic dipole*.

The results obtained above can be shown to apply to any planar loop: a planar current loop is equivalent to a magnetic dipole of dipole moment $\mathbf{m} = IA$, which is the analogue of electric dipole moment \mathbf{p} . Note, however, a fundamental difference: an electric dipole is built up of two elementary units — the charges (or electric monopoles). In magnetism, a magnetic dipole (or a current loop) is the most elementary element. The equivalent of electric charges, i.e., magnetic monopoles, are not known to exist.

We have shown that a current loop (i) produces a magnetic field (see Fig. 4.10) and behaves like a magnetic dipole at large distances, and (ii) is subject to torque like a magnetic needle. This led Ampere to suggest that all magnetism is due to circulating currents. This seems to be partly true and no magnetic monopoles have been seen so far. However, elementary particles such as an electron or a proton also carry an *intrinsic* magnetic moment, not accounted by circulating currents.

4.10 THE MOVING COIL GALVANOMETER

Currents and voltages in circuits have been discussed extensively in Chapters 3. But how do we measure them? How do we claim that current in a circuit is 1.5 A or the voltage drop across a resistor is 1.2 V? Figure 4.20 exhibits a very useful instrument for this purpose: the *moving coil galvanometer* (MCG). It is a device whose principle can be understood on the basis of our discussion in Section 4.9.

The galvanometer consists of a coil, with many turns, free to rotate about a fixed axis (Fig. 4.20), in a uniform radial magnetic field. There is a cylindrical soft iron core which not only makes the field radial but also increases the strength of the magnetic field. When a current flows through the coil, a torque acts on it. This torque is given by Eq. (4.20) to be

$$\tau = NIAB$$

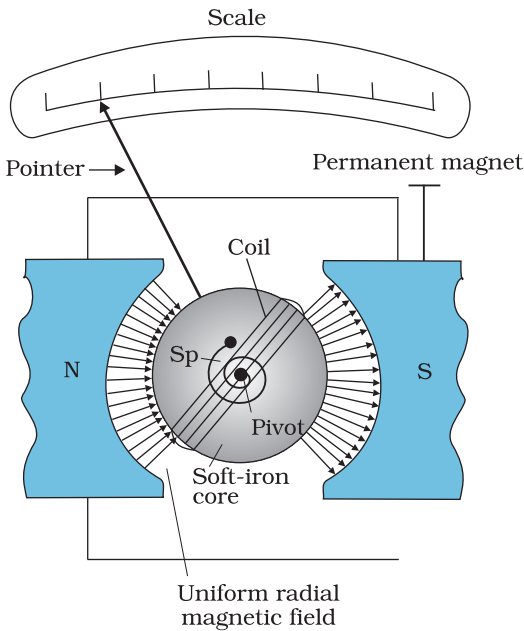

FIGURE 4.20 The moving coil galvanometer. Its elements are described in the text. Depending on the requirement, this device can be used as a current detector or for measuring the value of the current (ammeter) or voltage (voltmeter).

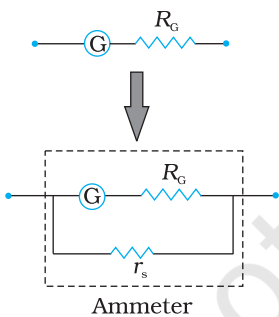

FIGURE 4.21 Conversion of a galvanometer (G) to an ammeter by the introduction of a shunt resistance r_s of very small value in parallel.

where the symbols have their usual meaning. Since the field is radial by design, we have taken $\sin \theta = 1$ in the above expression for the torque. The magnetic torque $NIAB$ tends to rotate the coil. A spring S_p provides a counter torque $k\phi$ that balances the magnetic torque $NIAB$; resulting in a steady angular deflection ϕ . In equilibrium

$$k\phi = NIAB$$

where k is the torsional constant of the spring; i.e. the restoring torque per unit twist. The deflection ϕ is indicated on the scale by a pointer attached to the spring. We have

$$\phi = \left(\frac{NAB}{k} \right) I \quad (4.26)$$

The quantity in brackets is a constant for a given galvanometer.

The galvanometer can be used in a number of ways. It can be used as a detector to check if a current is flowing in the circuit. We have come across this usage in the Wheatstone's bridge arrangement. In this usage the neutral position of the pointer (when no current is flowing through the galvanometer) is in the middle of the scale and not at the left end as shown in Fig.4.20. Depending on the direction of the current, the pointer's deflection is either to the right or the left.

The galvanometer cannot as such be used as an ammeter to measure the value of the current in a given circuit. This is for two reasons: (i) Galvanometer is a very sensitive device, it gives a full-scale deflection for a current of the order of μA . (ii) For measuring currents, the galvanometer has to be connected in series, and as it has a large resistance, this will change the value of the current in the circuit. To overcome these difficulties, one attaches a small resistance r_s , called *shunt resistance*, in parallel with the galvanometer coil; so that most of the current passes through the shunt. The resistance of this arrangement is,

$$R_G r_s / (R_G + r_s) \approx r_s \quad \text{if } R_G \gg r_s$$

If r_s has small value, in relation to the resistance of the rest of the circuit R_G , the effect of introducing the measuring instrument is also small and negligible. This arrangement is schematically shown in Fig. 4.21. The scale of this ammeter is calibrated and then graduated to read off the current value with ease. We define the *current sensitivity of the galvanometer as the deflection per unit current*. From Eq. (4.26) this current sensitivity is,

$$\frac{\phi}{I} = \frac{NAB}{k} \quad (4.27)$$

A convenient way for the manufacturer to increase the sensitivity is to increase the number of turns N . We choose galvanometers having sensitivities of value, required by our experiment.

Moving Charges and Magnetism

The galvanometer can also be used as a voltmeter to measure the voltage across a given section of the circuit. For this it must be connected *in parallel* with that section of the circuit. Further, it must draw a very small current, otherwise the voltage measurement will disturb the original set up by an amount which is very large. Usually we like to keep the disturbance due to the measuring device below one per cent. To ensure this, a large resistance R is connected *in series* with the galvanometer. This arrangement is schematically depicted in Fig.4.22. Note that the resistance of the voltmeter is now,

$$R_G + R \approx R: \text{ large}$$

The scale of the voltmeter is calibrated to read off the voltage value with ease. We define the *voltage sensitivity as the deflection per unit voltage*. From Eq. (4.26),

$$\frac{\phi}{V} = \left(\frac{NAB}{k} \right) \frac{I}{V} = \left(\frac{NAB}{k} \right) \frac{1}{R} \quad (4.28)$$

An interesting point to note is that increasing the current sensitivity may not necessarily increase the voltage sensitivity. Let us take Eq. (4.27) which provides a measure of current sensitivity. If $N \rightarrow 2N$, i.e., we double the number of turns, then

$$\frac{\phi}{I} \rightarrow 2 \frac{\phi}{I}$$

Thus, the current sensitivity doubles. However, the resistance of the galvanometer is also likely to double, since it is proportional to the length of the wire. In Eq. (4.28), $N \rightarrow 2N$, and $R \rightarrow 2R$, thus the voltage sensitivity,

$$\frac{\phi}{V} \rightarrow \frac{\phi}{V}$$

remains unchanged. So in general, the modification needed for conversion of a galvanometer to an ammeter will be different from what is needed for converting it into a voltmeter.

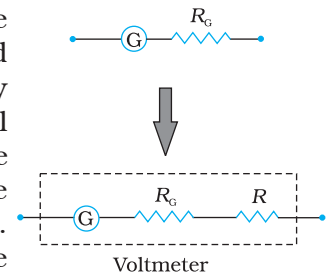

FIGURE 4.22
Conversion of a galvanometer (G) to a voltmeter by the introduction of a resistance R of large value in series.

Example 4.12 In the circuit (Fig. 4.23) the current is to be measured. What is the value of the current if the ammeter shown (a) is a galvanometer with a resistance $R_G = 60.00 \Omega$; (b) is a galvanometer described in (a) but converted to an ammeter by a shunt resistance $r_s = 0.02 \Omega$; (c) is an ideal ammeter with zero resistance?

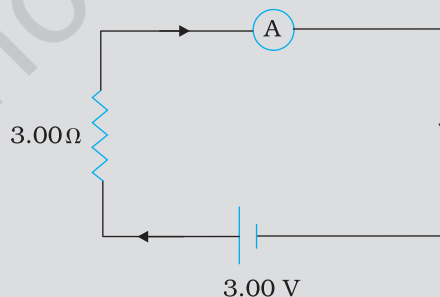

FIGURE 4.23

EXAMPLE 4.12

Solution

(a) Total resistance in the circuit is,

$$R_G + 3 = 63\Omega. \text{ Hence, } I = 3/63 = 0.048 \text{ A.}$$

(b) Resistance of the galvanometer converted to an ammeter is,

$$\frac{R_G r_s}{R_G + r_s} = \frac{60 \Omega \times 0.02\Omega}{(60 + 0.02)\Omega} \approx 0.02\Omega$$

Total resistance in the circuit is,

$$0.02\Omega + 3\Omega = 3.02\Omega. \text{ Hence, } I = 3/3.02 = 0.99 \text{ A.}$$

(c) For the ideal ammeter with zero resistance,

$$I = 3/3 = 1.00 \text{ A}$$

SUMMARY

1. The total force on a charge q moving with velocity \mathbf{v} in the presence of magnetic and electric fields \mathbf{B} and \mathbf{E} , respectively is called the *Lorentz force*. It is given by the expression:

$$\mathbf{F} = q (\mathbf{v} \times \mathbf{B} + \mathbf{E})$$

The magnetic force $q (\mathbf{v} \times \mathbf{B})$ is normal to \mathbf{v} and work done by it is zero.

2. A straight conductor of length l and carrying a steady current I experiences a force \mathbf{F} in a uniform external magnetic field \mathbf{B} ,

$$\mathbf{F} = I \mathbf{l} \times \mathbf{B}$$

where $|\mathbf{l}| = l$ and the direction of \mathbf{l} is given by the direction of the current.

3. In a uniform magnetic field \mathbf{B} , a charge q executes a circular orbit in a plane normal to \mathbf{B} . Its frequency of uniform circular motion is called the *cyclotron frequency* and is given by:

$$\nu_c = \frac{qB}{2\pi m}$$

This frequency is independent of the particle's speed and radius. This fact is exploited in a machine, the cyclotron, which is used to accelerate charged particles.

4. The *Biot-Savart* law asserts that the magnetic field $d\mathbf{B}$ due to an element $d\mathbf{l}$ carrying a steady current I at a point P at a distance r from the current element is:

$$d\mathbf{B} = \frac{\mu_0}{4\pi} I \frac{d\mathbf{l} \times \mathbf{r}}{r^3}$$

To obtain the total field at P, we must integrate this vector expression over the entire length of the conductor.

5. The magnitude of the magnetic field due to a circular coil of radius R carrying a current I at an axial distance x from the centre is

$$B = \frac{\mu_0 IR^2}{2(x^2 + R^2)^{3/2}}$$

At the centre this reduces to

$$B = \frac{\mu_0 I}{2R}$$

6. *Ampere's Circuital Law:* Let an open surface S be bounded by a loop C . Then the Ampere's law states that $\oint_C \mathbf{B} \cdot d\mathbf{l} = \mu_0 I$ where I refers to the current passing through S . The sign of I is determined from the right-hand rule. We have discussed a simplified form of this law. If \mathbf{B} is directed along the tangent to every point on the perimeter L of a closed curve and is constant in magnitude along perimeter then,

$$BL = \mu_0 I_e$$

where I_e is the net current enclosed by the closed circuit.

7. The magnitude of the magnetic field at a distance R from a long, straight wire carrying a current I is given by:

$$B = \frac{\mu_0 I}{2\pi R}$$

The field lines are circles concentric with the wire.

8. The magnitude of the field B inside a *long solenoid* carrying a current I is

$$B = \mu_0 nI$$

where n is the number of turns per unit length.

9. Parallel currents attract and anti-parallel currents repel.
10. A planar loop carrying a current I , having N closely wound turns, and an area A possesses a magnetic moment \mathbf{m} where,

$$\mathbf{m} = N I A$$

and the direction of \mathbf{m} is given by the right-hand thumb rule : curl the palm of your right hand along the loop with the fingers pointing in the direction of the current. The thumb sticking out gives the direction of \mathbf{m} (and \mathbf{A})

When this loop is placed in a uniform magnetic field \mathbf{B} , the force \mathbf{F} on it is: $F = 0$

And the torque on it is,

$$\tau = \mathbf{m} \times \mathbf{B}$$

In a moving coil galvanometer, this torque is balanced by a counter-torque due to a spring, yielding

$$k\phi = NIAB$$

where ϕ is the equilibrium deflection and k the torsion constant of the spring.

11. A moving coil galvanometer can be converted into a ammeter by introducing a shunt resistance r_s , of small value in parallel. It can be converted into a voltmeter by introducing a resistance of a large value in series.

Physical Quantity	Symbol	Nature	Dimensions	Units	Remarks
Permeability of free space	μ_0	Scalar	$[MLT^{-2}A^{-2}]$	$T\ m\ A^{-1}$	$4\pi \times 10^{-7}\ T\ m\ A^{-1}$
Magnetic Field	B	Vector	$[M\ T^{-2}A^{-1}]$	T (telsa)	
Magnetic Moment	m	Vector	$[L^2A]$	$A\ m^2$ or J/T	
Torsion Constant	k	Scalar	$[M\ L^2T^{-2}]$	$N\ m\ rad^{-1}$	Appears in MCG

POINTS TO PONDER

1. Electrostatic field lines originate at a positive charge and terminate at a negative charge or fade at infinity. Magnetic field lines always form closed loops.
2. The discussion in this Chapter holds only for steady currents which do not vary with time.
When currents vary with time Newton's third law is valid only if momentum carried by the electromagnetic field is taken into account.
3. Recall the expression for the Lorentz force,

$$\mathbf{F} = q(\mathbf{v} \times \mathbf{B} + \mathbf{E})$$

This velocity dependent force has occupied the attention of some of the greatest scientific thinkers. If one switches to a frame with instantaneous velocity \mathbf{v} , the magnetic part of the force vanishes. The motion of the charged particle is then explained by arguing that there exists an appropriate electric field in the new frame. We shall not discuss the details of this mechanism. However, we stress that the resolution of this paradox implies that electricity and magnetism are linked phenomena (*electromagnetism*) and that the Lorentz force expression *does not* imply a universal preferred frame of reference in nature.

4. Ampere's Circuital law is not independent of the Biot-Savart law. It can be derived from the Biot-Savart law. Its relationship to the Biot-Savart law is similar to the relationship between Gauss's law and Coulomb's law.

EXERCISES

- 4.1 A circular coil of wire consisting of 100 turns, each of radius 8.0 cm carries a current of 0.40 A. What is the magnitude of the magnetic field **B** at the centre of the coil?
- 4.2 A long straight wire carries a current of 35 A. What is the magnitude of the field **B** at a point 20 cm from the wire?
- 4.3 A long straight wire in the horizontal plane carries a current of 50 A in north to south direction. Give the magnitude and direction of **B** at a point 2.5 m east of the wire.

- 4.4 A horizontal overhead power line carries a current of 90 A in east to west direction. What is the magnitude and direction of the magnetic field due to the current 1.5 m below the line?
- 4.5 What is the magnitude of magnetic force per unit length on a wire carrying a current of 8 A and making an angle of 30° with the direction of a uniform magnetic field of 0.15 T?
- 4.6 A 3.0 cm wire carrying a current of 10 A is placed inside a solenoid perpendicular to its axis. The magnetic field inside the solenoid is given to be 0.27 T. What is the magnetic force on the wire?
- 4.7 Two long and parallel straight wires A and B carrying currents of 8.0 A and 5.0 A in the same direction are separated by a distance of 4.0 cm. Estimate the force on a 10 cm section of wire A.
- 4.8 A closely wound solenoid 80 cm long has 5 layers of windings of 400 turns each. The diameter of the solenoid is 1.8 cm. If the current carried is 8.0 A, estimate the magnitude of B inside the solenoid near its centre.
- 4.9 A square coil of side 10 cm consists of 20 turns and carries a current of 12 A. The coil is suspended vertically and the normal to the plane of the coil makes an angle of 30° with the direction of a uniform horizontal magnetic field of magnitude 0.80 T. What is the magnitude of torque experienced by the coil?
- 4.10 Two moving coil meters, M_1 and M_2 have the following particulars:
 $R_1 = 10 \Omega$, $N_1 = 30$,
 $A_1 = 3.6 \times 10^{-3} \text{ m}^2$, $B_1 = 0.25 \text{ T}$
 $R_2 = 14 \Omega$, $N_2 = 42$,
 $A_2 = 1.8 \times 10^{-3} \text{ m}^2$, $B_2 = 0.50 \text{ T}$
 (The spring constants are identical for the two meters).
 Determine the ratio of (a) current sensitivity and (b) voltage sensitivity of M_2 and M_1 .
- 4.11 In a chamber, a uniform magnetic field of 6.5 G ($1 \text{ G} = 10^{-4} \text{ T}$) is maintained. An electron is shot into the field with a speed of $4.8 \times 10^6 \text{ m s}^{-1}$ normal to the field. Explain why the path of the electron is a circle. Determine the radius of the circular orbit. ($e = 1.5 \times 10^{-19} \text{ C}$, $m_e = 9.1 \times 10^{-31} \text{ kg}$)
- 4.12 In Exercise 4.11 obtain the frequency of revolution of the electron in its circular orbit. Does the answer depend on the speed of the electron? Explain.
- 4.13 (a) A circular coil of 30 turns and radius 8.0 cm carrying a current of 6.0 A is suspended vertically in a uniform horizontal magnetic field of magnitude 1.0 T. The field lines make an angle of 60° with the normal of the coil. Calculate the magnitude of the counter torque that must be applied to prevent the coil from turning.
 (b) Would your answer change, if the circular coil in (a) were replaced by a planar coil of some irregular shape that encloses the same area? (All other particulars are also unaltered.)

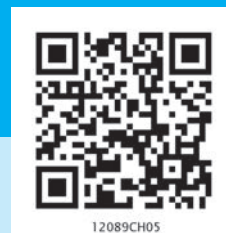

Chapter Five

MAGNETISM AND MATTER



5.1 INTRODUCTION

Magnetic phenomena are universal in nature. Vast, distant galaxies, the tiny invisible atoms, humans and beasts all are permeated through and through with a host of magnetic fields from a variety of sources. The earth's magnetism predates human evolution. The word magnet is derived from the name of an island in Greece called *magnesia* where magnetic ore deposits were found, as early as 600 BC.

In the previous chapter we have learned that moving charges or electric currents produce magnetic fields. This discovery, which was made in the early part of the nineteenth century is credited to Oersted, Ampere, Biot and Savart, among others.

In the present chapter, we take a look at magnetism as a subject in its own right.

Some of the commonly known ideas regarding magnetism are:

- (i) The earth behaves as a magnet with the magnetic field pointing approximately from the geographic south to the north.
- (ii) When a bar magnet is freely suspended, it points in the north-south direction. The tip which points to the geographic north is called the *north pole* and the tip which points to the geographic south is called the *south pole* of the magnet.

- (iii) There is a repulsive force when north poles (or south poles) of two magnets are brought close together. Conversely, there is an attractive force between the north pole of one magnet and the south pole of the other.
- (iv) We cannot isolate the north, or south pole of a magnet. If a bar magnet is broken into two halves, we get two similar bar magnets with somewhat weaker properties. Unlike electric charges, isolated magnetic north and south poles known as *magnetic monopoles* do not exist.
- (v) It is possible to make magnets out of iron and its alloys.

We begin with a description of a bar magnet and its behaviour in an external magnetic field. We describe Gauss's law of magnetism. We next describe how materials can be classified on the basis of their magnetic properties. We describe para-, dia-, and ferromagnetism.

5.2 THE BAR MAGNET

We begin our study by examining iron filings sprinkled on a sheet of glass placed over a short bar magnet. The arrangement of iron filings is shown in Fig. 5.1.

The pattern of iron filings suggests that the magnet has two poles similar to the positive and negative charge of an electric dipole. As mentioned in the introductory section, one pole is designated the *North pole* and the other, the *South pole*. When suspended freely, these poles point approximately towards the geographic north and south poles, respectively. A similar pattern of iron filings is observed around a current carrying solenoid.

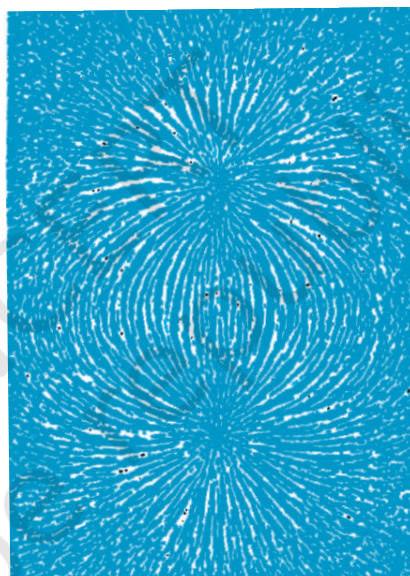

FIGURE 5.1 The arrangement of iron filings surrounding a bar magnet. The pattern mimics magnetic field lines. The pattern suggests that the bar magnet is a magnetic dipole.

5.2.1 The magnetic field lines

The pattern of iron filings permits us to plot the magnetic field lines*. This is shown both for the bar-magnet and the current-carrying solenoid in Fig. 5.2. For comparison refer to the Chapter 1, Figure 1.14(d). Electric field lines of an electric dipole are also displayed in Fig. 5.2(c). The magnetic field lines are a visual and intuitive realisation of the magnetic field. Their properties are:

- (i) The magnetic field lines of a magnet (or a solenoid) form continuous closed loops. This is unlike the electric dipole where these field lines begin from a positive charge and end on the negative charge or escape to infinity.

* In some textbooks the magnetic field lines are called *magnetic lines of force*. This nomenclature is avoided since it can be confusing. Unlike electrostatics the field lines in magnetism do not indicate the direction of the force on a (moving) charge.

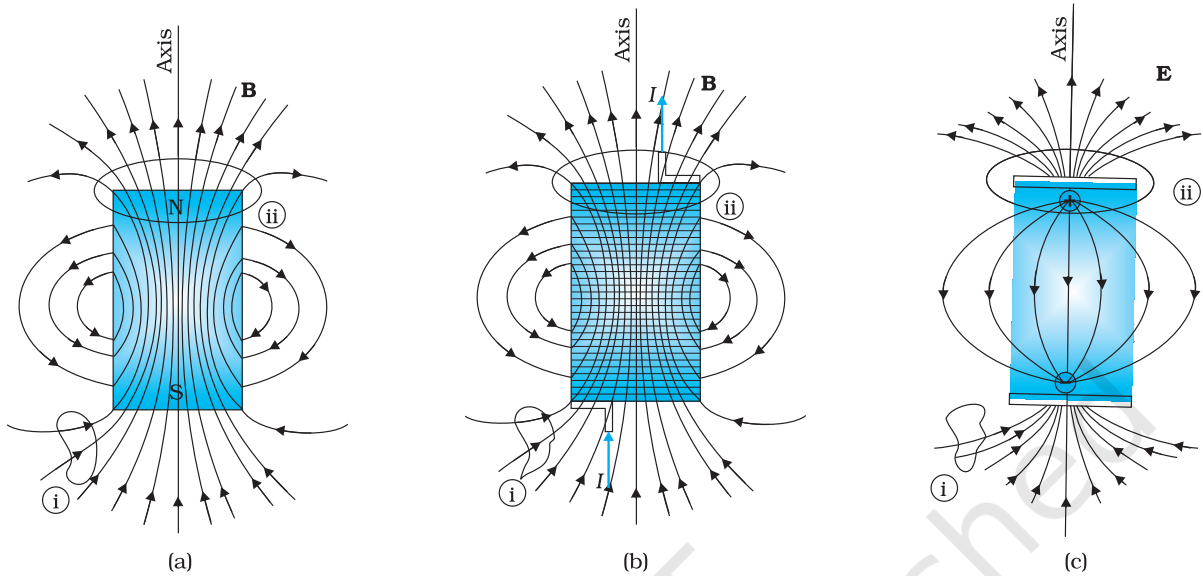

FIGURE 5.2 The field lines of (a) a bar magnet, (b) a current-carrying finite solenoid and (c) electric dipole. At large distances, the field lines are very similar. The curves labelled (i) and (ii) are closed Gaussian surfaces.

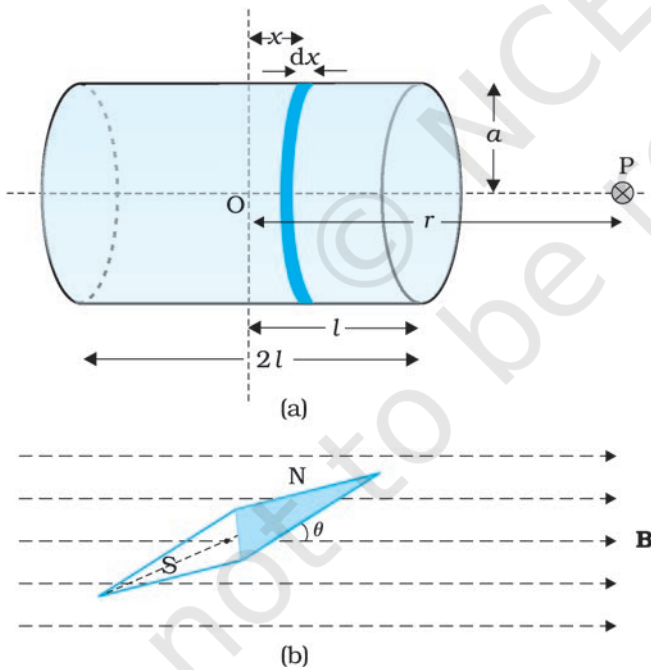

FIGURE 5.3 Calculation of (a) The axial field of a finite solenoid in order to demonstrate its similarity to that of a bar magnet. (b) A magnetic needle in a uniform magnetic field B . The arrangement may be used to determine either B or the magnetic moment m of the needle.

- (ii) The tangent to the field line at a given point represents the direction of the net magnetic field B at that point.
- (iii) The larger the number of field lines crossing per unit area, the stronger is the magnitude of the magnetic field B . In Fig. 5.2(a), B is larger around region ii than in region (i).
- (iv) The magnetic field lines do not intersect, for if they did, the direction of the magnetic field would not be unique at the point of intersection.

One can plot the magnetic field lines in a variety of ways. One way is to place a small magnetic compass needle at various positions and note its orientation. This gives us an idea of the magnetic field direction at various points in space.

5.2.2 Bar magnet as an equivalent solenoid

In the previous chapter, we have explained how a current loop acts as a magnetic dipole (Section 4.9). We mentioned Ampere's hypothesis that all magnetic phenomena can be explained in terms of circulating currents.

The resemblance of magnetic field lines for a bar magnet and a solenoid suggest that a bar magnet may be thought of as a large number of circulating currents in analogy with a solenoid. Cutting a bar magnet in half is like cutting a solenoid. We get two smaller solenoids with weaker magnetic properties. The field lines remain continuous, emerging from one face of the solenoid and entering into the other face. One can test this analogy by moving a small compass needle in the neighbourhood of a bar magnet and a current-carrying finite solenoid and noting that the deflections of the needle are similar in both cases.

To make this analogy more firm we may calculate the axial field of a finite solenoid depicted in Fig. 5.3 (a). We can demonstrate that at large distances this axial field resembles that of a bar magnet.

The magnitude of the field at point P due to the solenoid is

$$B = \frac{\mu_0}{4\pi} \frac{2m}{r^3} \quad (5.1)$$

This is also the far axial magnetic field of a bar magnet which one may obtain experimentally. Thus, a bar magnet and a solenoid produce similar magnetic fields. The magnetic moment of a bar magnet is thus equal to the magnetic moment of an equivalent solenoid that produces the same magnetic field.

5.2.3 The dipole in a uniform magnetic field

Let's place a small compass needle of known magnetic moment \mathbf{m} allowing it to oscillate in the magnetic field. This arrangement is shown in Fig. 5.3(b).

The torque on the needle is [see Eq. (4.23)],

$$\boldsymbol{\tau} = \mathbf{m} \times \mathbf{B} \quad (5.2)$$

In magnitude $\tau = mB \sin\theta$

Here $\boldsymbol{\tau}$ is restoring torque and θ is the angle between \mathbf{m} and \mathbf{B} .

An expression for magnetic potential energy can be obtained on lines similar to electrostatic potential energy.

The magnetic potential energy U_m is given by

$$\begin{aligned} U_m &= \int \tau(\theta) d\theta \\ &= \int mB \sin\theta d\theta = -mB \cos\theta \\ &= -\mathbf{m} \cdot \mathbf{B} \end{aligned} \quad (5.3)$$

We have emphasised in Chapter 2 that the zero of potential energy can be fixed at one's convenience. Taking the constant of integration to be zero means fixing the zero of potential energy at $\theta = 90^\circ$, i.e., when the needle is perpendicular to the field. Equation (5.3) shows that potential energy is minimum ($= -mB$) at $\theta = 0^\circ$ (most stable position) and maximum ($= +mB$) at $\theta = 180^\circ$ (most unstable position).

Example 5.1

- What happens if a bar magnet is cut into two pieces: (i) transverse to its length, (ii) along its length?
- A magnetised needle in a uniform magnetic field experiences a torque but no net force. An iron nail near a bar magnet, however, experiences a force of attraction in addition to a torque. Why?

- (c) Must every magnetic configuration have a north pole and a south pole? What about the field due to a toroid?
- (d) Two identical looking iron bars A and B are given, one of which is definitely known to be magnetised. (We do not know which one.) How would one ascertain whether or not both are magnetised? If only one is magnetised, how does one ascertain which one? [Use nothing else but the bars A and B.]

Solution

- (a) In either case, one gets two magnets, each with a north and south pole.
- (b) No force if the field is uniform. The iron nail experiences a non-uniform field due to the bar magnet. There is induced magnetic moment in the nail, therefore, it experiences both force and torque. The net force is attractive because the induced south pole (say) in the nail is closer to the north pole of magnet than induced north pole.
- (c) Not necessarily. True only if the source of the field has a net non-zero magnetic moment. This is not so for a toroid or even for a straight infinite conductor.
- (d) Try to bring different ends of the bars closer. A repulsive force in some situation establishes that both are magnetised. If it is always attractive, then one of them is not magnetised. In a bar magnet the intensity of the magnetic field is the strongest at the two ends (poles) and weakest at the central region. This fact may be used to determine whether A or B is the magnet. In this case, to see which one of the two bars is a magnet, pick up one, (say, A) and lower one of its ends; first on one of the ends of the other (say, B), and then on the middle of B. If you notice that in the middle of B, A experiences no force, then B is magnetised. If you do not notice any change from the end to the middle of B, then A is magnetised.

5.2.4 The electrostatic analog

Comparison of Eqs. (5.1), (5.2) and (5.3) with the corresponding equations for electric dipole (Chapter 1), suggests that magnetic field at large distances due to a bar magnet of magnetic moment \mathbf{m} can be obtained from the equation for electric field due to an electric dipole of dipole moment \mathbf{p} , by making the following replacements:

$$\mathbf{E} \rightarrow \mathbf{B}, \quad \mathbf{p} \rightarrow \mathbf{m}, \quad \frac{1}{4\pi\epsilon_0} \rightarrow \frac{\mu_0}{4\pi}$$

In particular, we can write down the equatorial field (\mathbf{B}_E) of a bar magnet at a distance r , for $r \gg l$, where l is the size of the magnet:

$$\mathbf{B}_E = -\frac{\mu_0 \mathbf{m}}{4\pi r^3} \tag{5.4}$$

Likewise, the axial field (\mathbf{B}_A) of a bar magnet for $r \gg l$ is:

$$\mathbf{B}_A = \frac{\mu_0}{4\pi} \frac{2\mathbf{m}}{r^3} \tag{5.5}$$

Equation (5.5) is just Eq. (5.1) in the vector form. Table 5.1 summarises the analogy between electric and magnetic dipoles.

TABLE 5.1 THE DIPOLE ANALOGY

	Electrostatics	Magnetism
Dipole moment	$1/\epsilon_0$ \mathbf{p}	μ_0 \mathbf{m}
Equatorial Field for a short dipole	$-\mathbf{p}/4\pi\epsilon_0 r^3$	$-\mu_0 \mathbf{m} / 4\pi r^3$
Axial Field for a short dipole	$2\mathbf{p}/4\pi\epsilon_0 r^3$	$\mu_0 2\mathbf{m} / 4\pi r^3$
External Field: torque	$\mathbf{p} \times \mathbf{E}$	$\mathbf{m} \times \mathbf{B}$
External Field: Energy	$-\mathbf{p} \cdot \mathbf{E}$	$-\mathbf{m} \cdot \mathbf{B}$

Example 5.2 Figure 5.4 shows a small magnetised needle P placed at a point O. The arrow shows the direction of its magnetic moment. The other arrows show different positions (and orientations) of the magnetic moment) of another identical magnetised needle Q.

- (a) In which configuration is the system not in equilibrium?
- (b) In which configuration is the system in (i) stable, and (ii) unstable equilibrium?
- (c) Which configuration corresponds to the lowest potential energy among all the configurations shown?

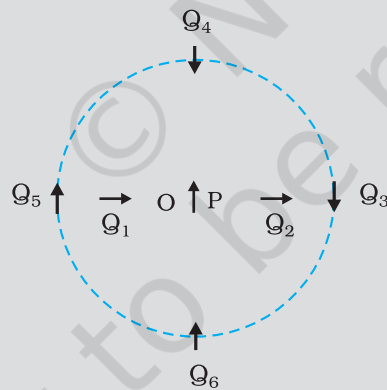

FIGURE 5.4

Solution

Potential energy of the configuration arises due to the potential energy of one dipole (say, Q) in the magnetic field due to other (P). Use the result that the field due to P is given by the expression [Eqs. (5.4) and (5.5)]:

$$\mathbf{B}_P = -\frac{\mu_0}{4\pi} \frac{\mathbf{m}_P}{r^3} \quad (\text{on the normal bisector})$$

$$\mathbf{B}_P = \frac{\mu_0 2}{4\pi} \frac{\mathbf{m}_P}{r^3} \quad (\text{on the axis})$$

where \mathbf{m}_P is the magnetic moment of the dipole P. Equilibrium is stable when \mathbf{m}_Q is parallel to \mathbf{B}_P , and unstable when it is anti-parallel to \mathbf{B}_P .

EXAMPLE 5.2

EXAMPLE 5.2

For instance for the configuration Q_3 for which Q is along the perpendicular bisector of the dipole P , the magnetic moment of Q is parallel to the magnetic field at the position 3. Hence Q_3 is stable. Thus,

- (a) PQ_1 and PQ_2
- (b) (i) PQ_3, PQ_6 (stable); (ii) PQ_5, PQ_4 (unstable)
- (c) PQ_6

KARL FRIEDRICH GAUSS (1777 – 1855)



Karl Friedrich Gauss (1777 – 1855) He was a child prodigy and was gifted in mathematics, physics, engineering, astronomy and even land surveying. The properties of numbers fascinated him, and in his work he anticipated major mathematical development of later times. Along with Wilhelm Welsler, he built the first electric telegraph in 1833. His mathematical theory of curved surface laid the foundation for the later work of Riemann.

5.3 MAGNETISM AND GAUSS’S LAW

In Chapter 1, we studied Gauss’s law for electrostatics. In Fig 5.2(c), we see that for a closed surface represented by (i), the number of lines leaving the surface is equal to the number of lines entering it. This is consistent with the fact that no net charge is enclosed by the surface. However, in the same figure, for the closed surface (ii), there is a net outward flux, since it does include a net (positive) charge.

The situation is radically different for magnetic fields which are continuous and form closed loops. Examine the Gaussian surfaces represented by (i) or (ii) in Fig 5.2(a) or Fig. 5.2(b). Both cases visually demonstrate that the number of magnetic field lines leaving the surface is balanced by the number of lines entering it. The *net magnetic flux is zero for both the surfaces*. This is true for any closed surface.

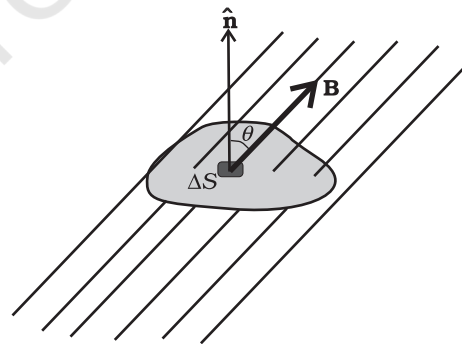

FIGURE 5.5

Consider a small vector area element $\Delta\mathbf{S}$ of a closed surface S as in Fig. 5.5. The magnetic flux through $\Delta\mathbf{S}$ is defined as $\Delta\phi_B = \mathbf{B} \cdot \Delta\mathbf{S}$, where \mathbf{B} is the field at $\Delta\mathbf{S}$. We divide S into many small area elements and calculate the individual flux through each. Then, the net flux ϕ_B is,

$$\phi_B = \sum_{\text{all}} \Delta\phi_B = \sum_{\text{all}} \mathbf{B} \cdot \Delta\mathbf{S} = 0 \tag{5.6}$$

where ‘all’ stands for ‘all area elements $\Delta\mathbf{S}$ ’. Compare this with the Gauss’s law of electrostatics. The flux through a closed surface in that case is given by

$$\sum \mathbf{E} \cdot \Delta\mathbf{S} = \frac{q}{\epsilon_0}$$

where q is the electric charge enclosed by the surface.

The difference between the Gauss's law of magnetism and that for electrostatics is a reflection of the fact that isolated magnetic poles (also called monopoles) are not known to exist. There are no sources or sinks of \mathbf{B} ; the simplest magnetic element is a dipole or a current loop. All magnetic phenomena can be explained in terms of an arrangement of dipoles and/or current loops.

Thus, Gauss's law for magnetism is:

The net magnetic flux through any closed surface is zero.

Example 5.3 Many of the diagrams given in Fig. 5.6 show magnetic field lines (thick lines in the figure) *wrongly*. Point out what is wrong with them. Some of them may describe electrostatic field lines correctly. Point out which ones.

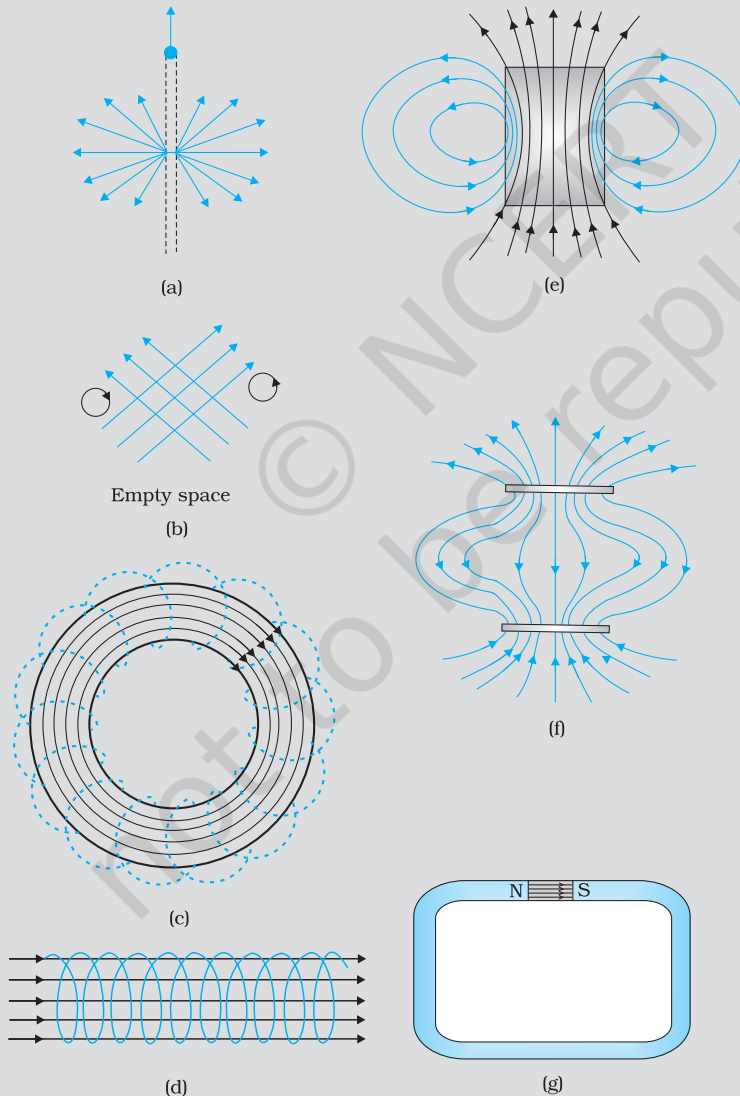

FIGURE 5.6

Solution

- (a) *Wrong.* Magnetic field lines can never emanate from a point, as shown in figure. Over any closed surface, the net flux of \mathbf{B} must always be zero, i.e., pictorially as many field lines should seem to enter the surface as the number of lines leaving it. The field lines shown, in fact, represent electric field of a long positively charged wire. The correct magnetic field lines are circling the straight conductor, as described in Chapter 4.
- (b) *Wrong.* Magnetic field lines (like electric field lines) can never cross each other, because otherwise the direction of field at the point of intersection is ambiguous. There is further error in the figure. Magnetostatic field lines can never form closed loops around empty space. A closed loop of static magnetic field line must enclose a region across which a current is passing. By contrast, electrostatic field lines can never form closed loops, neither in empty space, nor when the loop encloses charges.
- (c) *Right.* Magnetic lines are completely confined within a toroid. Nothing wrong here in field lines forming closed loops, since each loop encloses a region across which a current passes. Note, for clarity of figure, only a few field lines within the toroid have been shown. Actually, the entire region enclosed by the windings contains magnetic field.
- (d) *Wrong.* Field lines due to a solenoid at its ends and outside cannot be so completely straight and confined; such a thing violates Ampere's law. The lines should curve out at both ends, and meet eventually to form closed loops.
- (e) *Right.* These are field lines outside and inside a bar magnet. Note carefully the direction of field lines inside. Not all field lines emanate out of a north pole (or converge into a south pole). Around both the N-pole, and the S-pole, the net flux of the field is zero.
- (f) *Wrong.* These field lines cannot possibly represent a magnetic field. Look at the upper region. All the field lines seem to emanate out of the shaded plate. The net flux through a surface surrounding the shaded plate is not zero. This is impossible for a magnetic field. The given field lines, in fact, show the electrostatic field lines around a positively charged upper plate and a negatively charged lower plate. The difference between Fig. [5.6(e) and (f)] should be carefully grasped.
- (g) *Wrong.* Magnetic field lines between two pole pieces cannot be precisely straight at the ends. Some fringing of lines is inevitable. Otherwise, Ampere's law is violated. This is also true for electric field lines.

Example 5.4

- (a) Magnetic field lines show the direction (at every point) along which a small magnetised needle aligns (at the point). Do the magnetic field lines also represent the *lines of force* on a moving charged particle at every point?
- (b) If magnetic monopoles existed, how would the Gauss's law of magnetism be modified?
- (c) Does a bar magnet exert a torque on itself due to its own field? Does one element of a current-carrying wire exert a force on another element of the *same wire*?

- (d) Magnetic field arises due to charges in motion. Can a system have magnetic moments even though its net charge is zero?

Solution

(a) *No.* The magnetic force is always normal to \mathbf{B} (remember magnetic force = $q\mathbf{v} \times \mathbf{B}$). It is misleading to call *magnetic field lines* as *lines of force*.

(b) Gauss's law of magnetism states that the flux of \mathbf{B} through any closed surface is always zero $\int_S \mathbf{B} \cdot \Delta \mathbf{s} = 0$.

If monopoles existed, the right hand side would be equal to the monopole (magnetic charge) q_m enclosed by S . [Analogous to

Gauss's law of electrostatics, $\int_S \mathbf{B} \cdot \Delta \mathbf{s} = \mu_0 q_m$ where q_m is the (monopole) magnetic charge enclosed by S .]

(c) *No.* There is no force or torque on an element due to the field produced by that element itself. But there is a force (or torque) on an element of the same wire. (For the special case of a straight wire, this force is zero.)

(d) *Yes.* The average of the charge in the system may be zero. Yet, the mean of the magnetic moments due to various current loops may not be zero. We will come across such examples in connection with paramagnetic material where atoms have net dipole moment through their net charge is zero.

EXAMPLE 5.4

5.4 MAGNETISATION AND MAGNETIC INTENSITY

The earth abounds with a bewildering variety of elements and compounds. In addition, we have been synthesising new alloys, compounds and even elements. One would like to classify the magnetic properties of these substances. In the present section, we define and explain certain terms which will help us to carry out this exercise.

We have seen that a circulating electron in an atom has a magnetic moment. In a bulk material, these moments add up vectorially and they can give a net magnetic moment which is non-zero. We define *magnetisation* \mathbf{M} of a sample to be equal to its net magnetic moment per unit volume:

$$\mathbf{M} = \frac{\mathbf{m}_{net}}{V} \quad (5.7)$$

\mathbf{M} is a vector with dimensions $L^{-1} A$ and is measured in a units of $A m^{-1}$.

Consider a long solenoid of n turns per unit length and carrying a current I . The magnetic field in the interior of the solenoid was shown to be given by

$$\mathbf{B}_0 = \mu_0 nI \quad (5.8)$$

If the interior of the solenoid is filled with a material with non-zero magnetisation, the field inside the solenoid will be greater than \mathbf{B}_0 . The net \mathbf{B} field in the interior of the solenoid may be expressed as

$$\mathbf{B} = \mathbf{B}_0 + \mathbf{B}_m \quad (5.9)$$

where \mathbf{B}_m is the field contributed by the material core. It turns out that this additional field \mathbf{B}_m is proportional to the magnetisation \mathbf{M} of the material and is expressed as

$$\mathbf{B}_m = \mu_0 \mathbf{M} \quad (5.10)$$

where μ_0 is the same constant (permeability of vacuum) that appears in Biot-Savart's law.

It is convenient to introduce another vector field \mathbf{H} , called the *magnetic intensity*, which is defined by

$$\mathbf{H} = \frac{\mathbf{B}}{\mu_0} - \mathbf{M} \quad (5.11)$$

where \mathbf{H} has the same dimensions as \mathbf{M} and is measured in units of A m^{-1} . Thus, the total magnetic field \mathbf{B} is written as

$$\mathbf{B} = \mu_0 (\mathbf{H} + \mathbf{M}) \quad (5.12)$$

We repeat our defining procedure. We have partitioned the contribution to the total magnetic field inside the sample into two parts: *one*, due to external factors such as the current in the solenoid. This is represented by \mathbf{H} . The *other* is due to the specific nature of the magnetic material, namely \mathbf{M} . The latter quantity can be influenced by external factors. This influence is mathematically expressed as

$$\mathbf{M} = \chi \mathbf{H} \quad (5.13)$$

where χ , a dimensionless quantity, is appropriately called the *magnetic susceptibility*. It is a measure of how a magnetic material responds to an external field. χ is small and positive for materials, which are called *paramagnetic*. It is small and negative for materials, which are termed *diamagnetic*. In the latter case \mathbf{M} and \mathbf{H} are opposite in direction. From Eqs. (5.12) and (5.13) we obtain,

$$\mathbf{B} = \mu_0 (1 + \chi) \mathbf{H} \quad (5.14)$$

$$= \mu_0 \mu_r \mathbf{H}$$

$$= \mu \mathbf{H} \quad (5.15)$$

where $\mu_r = 1 + \chi$, is a dimensionless quantity called the *relative magnetic permeability* of the substance. It is the analog of the dielectric constant in electrostatics. The *magnetic permeability* of the substance is μ and it has the same dimensions and units as μ_0 ;

$$\mu = \mu_0 \mu_r = \mu_0 (1 + \chi).$$

The three quantities χ , μ_r and μ are interrelated and only one of them is independent. Given one, the other two may be easily determined.

EXAMPLE 5.5

Example 5.5 A solenoid has a core of a material with relative permeability 400. The windings of the solenoid are insulated from the core and carry a current of 2A. If the number of turns is 1000 per metre, calculate (a) H , (b) M , (c) B and (d) the magnetising current I_m .

Solution

(a) The field H is dependent of the material of the core, and is

$$H = nI = 1000 \times 2.0 = 2 \times 10^3 \text{ A/m.}$$

(b) The magnetic field B is given by

$$\begin{aligned} B &= \mu_r \mu_0 H \\ &= 400 \times 4\pi \times 10^{-7} \text{ (N/A}^2\text{)} \times 2 \times 10^3 \text{ (A/m)} \\ &= 1.0 \text{ T} \end{aligned}$$

(c) Magnetisation is given by

$$\begin{aligned} M &= (B - \mu_0 H) / \mu_0 \\ &= (\mu_r \mu_0 H - \mu_0 H) / \mu_0 = (\mu_r - 1)H = 399 \times H \\ &\cong 8 \times 10^5 \text{ A/m} \end{aligned}$$

(d) The magnetising current I_M is the additional current that needs to be passed through the windings of the solenoid in the absence of the core which would give a B value as in the presence of the core. Thus $B = \mu_r n (I + I_M)$. Using $I = 2\text{A}$, $B = 1 \text{ T}$, we get $I_M = 794 \text{ A}$.

EXAMPLE 5.5

5.5 MAGNETIC PROPERTIES OF MATERIALS

The discussion in the previous section helps us to classify materials as diamagnetic, paramagnetic or ferromagnetic. In terms of the susceptibility χ , a material is diamagnetic if χ is negative, para- if χ is positive and small, and ferro- if χ is large and positive.

A glance at Table 5.2 gives one a better feeling for these materials. Here ε is a small positive number introduced to quantify paramagnetic materials. Next, we describe these materials in some detail.

TABLE 5.2

Diamagnetic	Paramagnetic	Ferromagnetic
$-1 \leq \chi < 0$	$0 < \chi < \varepsilon$	$\chi \gg 1$
$0 \leq \mu_r < 1$	$1 < \mu_r < 1 + \varepsilon$	$\mu_r \gg 1$
$\mu < \mu_0$	$\mu > \mu_0$	$\mu \gg \mu_0$

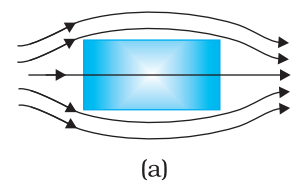

(a)

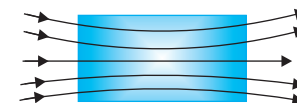

(b)

FIGURE 5.7
Behaviour of magnetic field lines near a
(a) diamagnetic,
(b) paramagnetic substance.

5.5.1 Diamagnetism

Diamagnetic substances are those which have tendency to move from stronger to the weaker part of the external magnetic field. In other words, unlike the way a magnet attracts metals like iron, it would repel a diamagnetic substance.

Figure 5.7(a) shows a bar of diamagnetic material placed in an external magnetic field. The field lines are repelled or expelled and the field inside the material is reduced. In most cases, this reduction is slight, being one part in 10^5 . When placed in a non-uniform magnetic field, the bar will tend to move from high to low field.

The simplest explanation for diamagnetism is as follows. Electrons in an atom orbiting around nucleus possess orbital angular momentum. These orbiting electrons are equivalent to current-carrying loop and thus possess orbital magnetic moment. Diamagnetic substances are the ones in which resultant magnetic moment in an atom is zero. When magnetic field is applied, those electrons having orbital magnetic moment in the same direction slow down and those in the opposite direction speed up. This happens due to induced current in accordance with Lenz's law which you will study in Chapter 6. Thus, the substance develops a net magnetic moment in direction opposite to that of the applied field and hence repulsion.

Some diamagnetic materials are bismuth, copper, lead, silicon, nitrogen (at STP), water and sodium chloride. Diamagnetism is present in all the substances. However, the effect is so weak in most cases that it gets shifted by other effects like paramagnetism, ferromagnetism, etc.

The most exotic diamagnetic materials are *superconductors*. These are metals, cooled to very low temperatures which exhibits both *perfect conductivity* and *perfect diamagnetism*. Here the field lines are completely expelled! $\chi = -1$ and $\mu_r = 0$. A superconductor repels a magnet and (by Newton's third law) is repelled by the magnet. The phenomenon of perfect diamagnetism in superconductors is called the *Meissner effect*, after the name of its discoverer. Superconducting magnets can be gainfully exploited in variety of situations, for example, for running magnetically levitated superfast trains.

5.5.2 Paramagnetism

Paramagnetic substances are those which get weakly magnetised when placed in an external magnetic field. They have tendency to move from a region of weak magnetic field to strong magnetic field, i.e., they get weakly attracted to a magnet.

The individual atoms (or ions or molecules) of a paramagnetic material possess a permanent magnetic dipole moment of their own. On account of the ceaseless random thermal motion of the atoms, no net magnetisation is seen. In the presence of an external field \mathbf{B}_0 , which is strong enough, and at low temperatures, the individual atomic dipole moment can be made to align and point in the same direction as \mathbf{B}_0 . Figure 5.7(b) shows a bar of paramagnetic material placed in an external field. The field lines gets concentrated inside the material, and the field inside is enhanced. In most cases, this enhancement is slight, being one part in 10^5 . When placed in a non-uniform magnetic field, the bar will tend to move from weak field to strong.

Some paramagnetic materials are aluminium, sodium, calcium, oxygen (at STP) and copper chloride. For a paramagnetic material both χ and μ_r depend not only on the material, but also (in a simple fashion) on the sample temperature. As the field is increased or the temperature is lowered, the magnetisation increases until it reaches the saturation value at which point all the dipoles are perfectly aligned with the field.

5.5.3 Ferromagnetism

Ferromagnetic substances are those which get strongly magnetised when placed in an external magnetic field. They have strong tendency to move from a region of weak magnetic field to strong magnetic field, i.e., they get strongly attracted to a magnet.

The individual atoms (or ions or molecules) in a ferromagnetic material possess a dipole moment as in a paramagnetic material. However, they interact with one another in such a way that they spontaneously align themselves in a common direction over a macroscopic volume called *domain*. The explanation of this cooperative effect requires quantum mechanics and is beyond the scope of this textbook. Each domain has a net magnetisation. Typical domain size is 1mm and the domain contains about 10^{11} atoms. In the first instant, the magnetisation varies randomly from domain to domain and there is no bulk magnetisation. This is shown in Fig. 5.8(a). When we apply an external magnetic field B_0 , the domains orient themselves in the direction of B_0 and simultaneously the domains oriented in the direction of B_0 grow in size. This existence of domains and their motion in B_0 are not speculations. One may observe this under a microscope after sprinkling a liquid suspension of powdered ferromagnetic substance of samples. This motion of suspension can be observed. Fig. 5.8(b) shows the situation when the domains have aligned and amalgamated to form a single 'giant' domain.

Thus, in a ferromagnetic material the field lines are highly concentrated. In non-uniform magnetic field, the sample tends to move towards the region of high field. We may wonder as to what happens when the external field is removed. In some ferromagnetic materials the magnetisation persists. Such materials are called *hard* magnetic materials or *hard ferromagnets*. Alnico, an alloy of iron, aluminium, nickel, cobalt and copper, is one such material. The naturally occurring lodestone is another. Such materials form permanent magnets to be used among other things as a compass needle. On the other hand, there is a class of ferromagnetic materials in which the magnetisation disappears on removal of the external field. Soft iron is one such material. Appropriately enough, such materials are called *soft ferromagnetic materials*. There are a number of elements, which are ferromagnetic: iron, cobalt, nickel, gadolinium, etc. The relative magnetic permeability is $>1000!$

The ferromagnetic property depends on temperature. At high enough temperature, a ferromagnet becomes a paramagnet. The domain structure disintegrates with temperature. This disappearance of magnetisation with temperature is gradual.

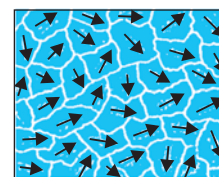

(a)

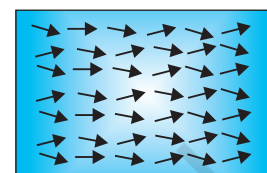

(b)

FIGURE 5.8
(a) Randomly oriented domains,
(b) Aligned domains.

SUMMARY

1. The science of magnetism is old. It has been known since ancient times that magnetic materials tend to point in the north-south direction; like

magnetic poles repel and unlike ones attract; and cutting a bar magnet in two leads to two smaller magnets. Magnetic poles cannot be isolated.

2. When a bar magnet of dipole moment \mathbf{m} is placed in a uniform magnetic field \mathbf{B} ,
 - (a) the force on it is zero,
 - (b) the torque on it is $\mathbf{m} \times \mathbf{B}$,
 - (c) its potential energy is $-\mathbf{m} \cdot \mathbf{B}$, where we choose the zero of energy at the orientation when \mathbf{m} is perpendicular to \mathbf{B} .

3. Consider a bar magnet of size l and magnetic moment \mathbf{m} , at a distance r from its mid-point, where $r \gg l$, the magnetic field \mathbf{B} due to this bar is,

$$\mathbf{B} = \frac{\mu_0 \mathbf{m}}{2\pi r^3} \quad (\text{along axis})$$

$$= -\frac{\mu_0 \mathbf{m}}{4\pi r^3} \quad (\text{along equator})$$

4. Gauss's law for magnetism states that the net magnetic flux through any closed surface is zero

$$\phi_B = \sum_{\text{all area elements } \Delta \mathbf{S}} \mathbf{B} \cdot \Delta \mathbf{S} = 0$$

5. Consider a material placed in an external magnetic field \mathbf{B}_0 . The magnetic intensity is defined as,

$$\mathbf{H} = \frac{\mathbf{B}_0}{\mu_0}$$

The magnetisation \mathbf{M} of the material is its dipole moment per unit volume. The magnetic field \mathbf{B} in the material is,

$$\mathbf{B} = \mu_0 (\mathbf{H} + \mathbf{M})$$

6. For a linear material $\mathbf{M} = \chi \mathbf{H}$. So that $\mathbf{B} = \mu \mathbf{H}$ and χ is called the magnetic susceptibility of the material. The three quantities, χ , the relative magnetic permeability μ_r , and the magnetic permeability μ are related as follows:

$$\mu = \mu_0 \mu_r$$

$$\mu_r = 1 + \chi$$

7. Magnetic materials are broadly classified as: diamagnetic, paramagnetic, and ferromagnetic. For diamagnetic materials χ is negative and small and for paramagnetic materials it is positive and small. Ferromagnetic materials have large χ and are characterised by non-linear relation between \mathbf{B} and \mathbf{H} .

8. Substances, which at room temperature, retain their ferromagnetic property for a long period of time are called permanent magnets.

Magnetism and Matter

Physical quantity	Symbol	Nature	Dimensions	Units	Remarks
Permeability of free space	μ_0	Scalar	$[MLT^{-2} A^{-2}]$	$T m A^{-1}$	$\mu_0/4\pi = 10^{-7}$
Magnetic field, Magnetic induction, Magnetic flux density	B	Vector	$[MT^{-2} A^{-1}]$	T (tesla)	10^4 G (gauss) = 1 T
Magnetic moment	m	Vector	$[L^{-2} A]$	$A m^2$	
Magnetic flux	ϕ_B	Scalar	$[ML^2T^{-2} A^{-1}]$	W (weber)	$W = T m^2$
Magnetisation	M	Vector	$[L^{-1} A]$	$A m^{-1}$	$\frac{\text{Magnetic moment}}{\text{Volume}}$
Magnetic intensity Magnetic field strength	H	Vector	$[L^{-1} A]$	$A m^{-1}$	$B = \mu_0 (H + M)$
Magnetic susceptibility	χ	Scalar	-	-	$M = \chi H$
Relative magnetic permeability	μ_r	Scalar	-	-	$B = \mu_0 \mu_r H$
Magnetic permeability	μ	Scalar	$[MLT^{-2} A^{-2}]$	$T m A^{-1}$ $N A^{-2}$	$\mu = \mu_0 \mu_r$ $B = \mu H$

POINTS TO PONDER

1. A satisfactory understanding of magnetic phenomenon in terms of moving charges/currents was arrived at after 1800 AD. But technological exploitation of the directional properties of magnets predates this scientific understanding by two thousand years. Thus, scientific understanding is not a necessary condition for engineering applications. Ideally, science and engineering go hand-in-hand, one leading and assisting the other in tandem.
2. Magnetic monopoles do not exist. If you slice a magnet in half, you get two smaller magnets. On the other hand, isolated positive and negative charges exist. There exists a smallest unit of charge, for example, the electronic charge with value $|e| = 1.6 \times 10^{-19}$ C. All other charges are integral multiples of this smallest unit charge. In other words, charge is quantised. We do not know why magnetic monopoles do not exist or why electric charge is quantised.
3. A consequence of the fact that magnetic monopoles do not exist is that the magnetic field lines are continuous and form closed loops. In contrast, the electrostatic lines of force begin on a positive charge and terminate on the negative charge (or fade out at infinity).
4. A miniscule difference in the value of χ , the magnetic susceptibility, yields radically different behaviour: diamagnetic versus paramagnetic. For diamagnetic materials $\chi = -10^{-5}$ whereas $\chi = +10^{-5}$ for paramagnetic materials.

5. There exists a *perfect diamagnet*, namely, a superconductor. This is a metal at very low temperatures. In this case $\chi = -1$, $\mu_r = 0$, $\mu = 0$. The external magnetic field is totally expelled. Interestingly, this material is also a perfect conductor. However, there exists no classical theory which ties these two properties together. A quantum-mechanical theory by Bardeen, Cooper, and Schrieffer (BCS theory) explains these effects. The BCS theory was proposed in 1957 and was eventually recognised by a Nobel Prize in physics in 1970.
6. Diamagnetism is universal. It is present in all materials. But it is weak and hard to detect if the substance is para- or ferromagnetic.
7. We have classified materials as diamagnetic, paramagnetic, and ferromagnetic. However, there exist additional types of magnetic material such as ferrimagnetic, anti-ferromagnetic, spin glass, etc. with properties which are exotic and mysterious.

EXERCISES

- 5.1 A short bar magnet placed with its axis at 30° with a uniform external magnetic field of 0.25 T experiences a torque of magnitude equal to 4.5×10^{-2} J. What is the magnitude of magnetic moment of the magnet?
- 5.2 A short bar magnet of magnetic moment $m = 0.32 \text{ JT}^{-1}$ is placed in a uniform magnetic field of 0.15 T. If the bar is free to rotate in the plane of the field, which orientation would correspond to its (a) stable, and (b) unstable equilibrium? What is the potential energy of the magnet in each case?
- 5.3 A closely wound solenoid of 800 turns and area of cross section $2.5 \times 10^{-4} \text{ m}^2$ carries a current of 3.0 A. Explain the sense in which the solenoid acts like a bar magnet. What is its associated magnetic moment?
- 5.4 If the solenoid in Exercise 5.3 is free to turn about the vertical direction and a uniform horizontal magnetic field of 0.25 T is applied, what is the magnitude of torque on the solenoid when its axis makes an angle of 30° with the direction of applied field?
- 5.5 A bar magnet of magnetic moment 1.5 J T^{-1} lies aligned with the direction of a uniform magnetic field of 0.22 T.
 - (a) What is the amount of work required by an external torque to turn the magnet so as to align its magnetic moment: (i) normal to the field direction, (ii) opposite to the field direction?
 - (b) What is the torque on the magnet in cases (i) and (ii)?
- 5.6 A closely wound solenoid of 2000 turns and area of cross-section $1.6 \times 10^{-4} \text{ m}^2$, carrying a current of 4.0 A, is suspended through its centre allowing it to turn in a horizontal plane.

- (a) What is the magnetic moment associated with the solenoid?
(b) What is the force and torque on the solenoid if a uniform horizontal magnetic field of 7.5×10^{-2} T is set up at an angle of 30° with the axis of the solenoid?
- 5.7 A short bar magnet has a magnetic moment of 0.48 J T^{-1} . Give the direction and magnitude of the magnetic field produced by the magnet at a distance of 10 cm from the centre of the magnet on (a) the axis, (b) the equatorial lines (normal bisector) of the magnet.

© NCERT
not to be republished

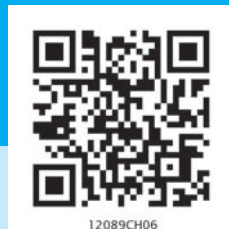

Chapter Six

ELECTROMAGNETIC INDUCTION



6.1 INTRODUCTION

Electricity and magnetism were considered separate and unrelated phenomena for a long time. In the early decades of the nineteenth century, experiments on electric current by Oersted, Ampere and a few others established the fact that electricity and magnetism are inter-related. They found that moving electric charges produce magnetic fields. For example, an electric current deflects a magnetic compass needle placed in its vicinity. This naturally raises the questions like: Is the converse effect possible? Can moving magnets produce electric currents? Does the nature permit such a relation between electricity and magnetism? The answer is resounding yes! The experiments of Michael Faraday in England and Joseph Henry in USA, conducted around 1830, demonstrated conclusively that electric currents were induced in closed coils when subjected to changing magnetic fields. In this chapter, we will study the phenomena associated with changing magnetic fields and understand the underlying principles. The phenomenon in which electric current is generated by varying magnetic fields is appropriately called *electromagnetic induction*.

When Faraday first made public his discovery that relative motion between a bar magnet and a wire loop produced a small current in the latter, he was asked, "What is the use of it?" His reply was: "What is the use of a new born baby?" The phenomenon of electromagnetic induction

is not merely of theoretical or academic interest but also of practical utility. Imagine a world where there is no electricity – no electric lights, no trains, no telephones and no personal computers. The pioneering experiments of Faraday and Henry have led directly to the development of modern day generators and transformers. Today's civilisation owes its progress to a great extent to the discovery of electromagnetic induction.

6.2 THE EXPERIMENTS OF FARADAY AND HENRY

The discovery and understanding of electromagnetic induction are based on a long series of experiments carried out by Faraday and Henry. We shall now describe some of these experiments.

Experiment 6.1

Figure 6.1 shows a coil C_1 connected to a galvanometer G. When the North-pole of a bar magnet is pushed towards the coil, the pointer in the galvanometer deflects, indicating the presence of electric current in the coil. The deflection lasts as long as the bar magnet is in motion. The galvanometer does not show any deflection when the magnet is held stationary. When the magnet is pulled away from the coil, the galvanometer shows deflection in the opposite direction, which indicates reversal of the current's direction. Moreover, when the South-pole of the bar magnet is moved towards or away from the coil, the deflections in the galvanometer are opposite to that observed with the North-pole for similar movements. Further, the deflection (and hence current) is found to be larger when the magnet is pushed towards or pulled away from the coil faster. Instead, when the bar magnet is held fixed and the coil C_1 is moved towards or away from the magnet, the same effects are observed. It shows that it is the relative motion between the magnet and the coil that is responsible for generation (induction) of electric current in the coil.

Experiment 6.2

In Fig. 6.2 the bar magnet is replaced by a second coil C_2 connected to a battery. The steady current in the coil C_2 produces a steady magnetic field. As coil C_2 is



Joseph Henry [1797 – 1878] American experimental physicist, professor at Princeton University and first director of the Smithsonian Institution. He made important improvements in electromagnets by winding coils of insulated wire around iron pole pieces and invented an electromagnetic motor and a new, efficient telegraph. He discovered self-induction and investigated how currents in one circuit induce currents in another.

JOSEPH HENRY (1797 – 1878)

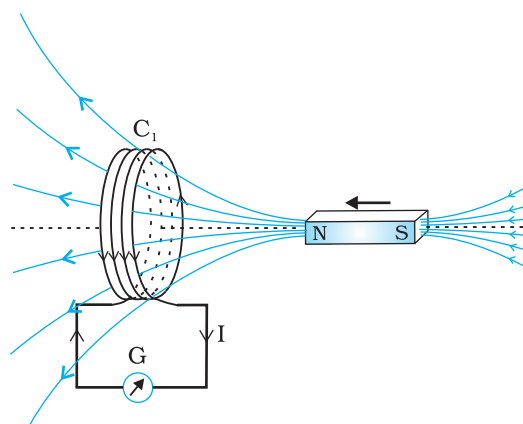

FIGURE 6.1 When the bar magnet is pushed towards the coil, the pointer in the galvanometer G deflects.

* Wherever the term 'coil' or 'loop' is used, it is assumed that they are made up of conducting material and are prepared using wires which are coated with insulating material.

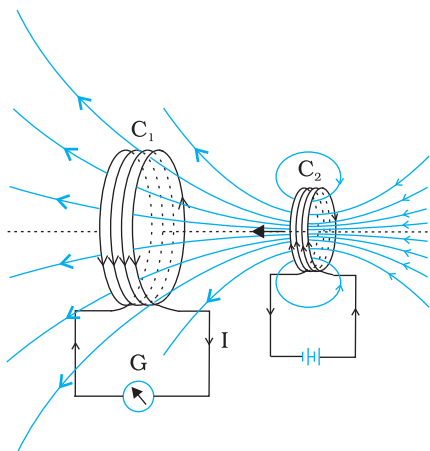

FIGURE 6.2 Current is induced in coil C_1 due to motion of the current carrying coil C_2 .

moved towards the coil C_1 , the galvanometer shows a deflection. This indicates that electric current is induced in coil C_1 . When C_2 is moved away, the galvanometer shows a deflection again, but this time in the opposite direction. The deflection lasts as long as coil C_2 is in motion. When the coil C_2 is held fixed and C_1 is moved, the same effects are observed. Again, it is the relative motion between the coils that induces the electric current.

Experiment 6.3

The above two experiments involved relative motion between a magnet and a coil and between two coils, respectively. Through another experiment, Faraday showed that this relative motion is not an absolute requirement. Figure 6.3 shows two coils C_1 and C_2 held stationary. Coil C_1 is connected to galvanometer G while the second coil C_2 is connected to a battery through a tapping key K .

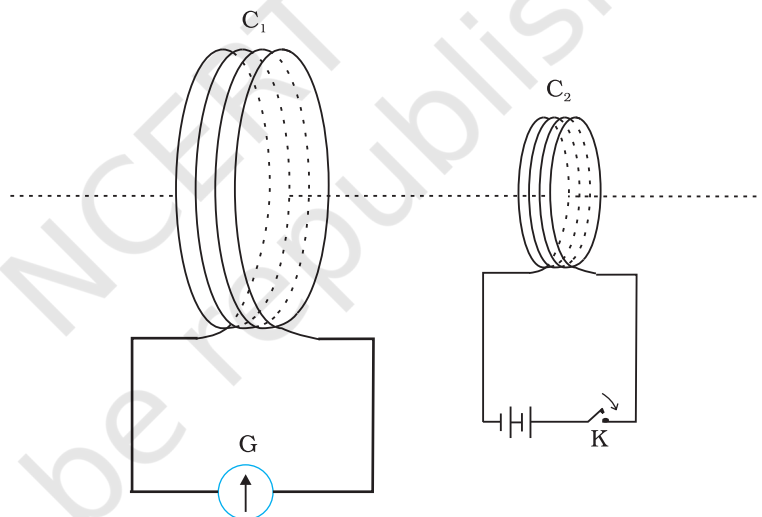

FIGURE 6.3 Experimental set-up for Experiment 6.3.

It is observed that the galvanometer shows a momentary deflection when the tapping key K is pressed. The pointer in the galvanometer returns to zero immediately. If the key is held pressed continuously, there is no deflection in the galvanometer. When the key is released, a momentary deflection is observed again, but in the opposite direction. It is also observed that the deflection increases dramatically when an iron rod is inserted into the coils along their axis.

6.3 MAGNETIC FLUX

Faraday's great insight lay in discovering a simple mathematical relation to explain the series of experiments he carried out on electromagnetic induction. However, before we state and appreciate his laws, we must get familiar with the notion of magnetic flux, Φ_B . Magnetic flux is defined in the same way as electric flux is defined in Chapter 1. Magnetic flux through

a plane of area A placed in a uniform magnetic field \mathbf{B} (Fig. 6.4) can be written as

$$\Phi_B = \mathbf{B} \cdot \mathbf{A} = BA \cos \theta \quad (6.1)$$

where θ is angle between \mathbf{B} and \mathbf{A} . The notion of the area as a vector has been discussed earlier in Chapter 1. Equation (6.1) can be extended to curved surfaces and nonuniform fields.

If the magnetic field has different magnitudes and directions at various parts of a surface as shown in Fig. 6.5, then the magnetic flux through the surface is given by

$$\Phi_B = \mathbf{B}_1 \cdot d\mathbf{A}_1 + \mathbf{B}_2 \cdot d\mathbf{A}_2 + \dots = \sum_{\text{all}} \mathbf{B}_i \cdot d\mathbf{A}_i \quad (6.2)$$

where 'all' stands for summation over all the area elements $d\mathbf{A}_i$ comprising the surface and \mathbf{B}_i is the magnetic field at the area element $d\mathbf{A}_i$. The SI unit of magnetic flux is weber (Wb) or tesla meter squared (T m^2). Magnetic flux is a scalar quantity.

6.4 FARADAY'S LAW OF INDUCTION

From the experimental observations, Faraday arrived at a conclusion that an emf is induced in a coil when magnetic flux through the coil changes with time. Experimental observations discussed in Section 6.2 can be explained using this concept.

The motion of a magnet towards or away from coil C_1 in Experiment 6.1 and moving a current-carrying coil C_2 towards or away from coil C_1 in Experiment 6.2, change the magnetic flux associated with coil C_1 . The change in magnetic flux induces emf in coil C_1 . It was this induced emf which caused electric current to flow in coil C_1 and through the galvanometer. A plausible explanation for the observations of Experiment 6.3 is as follows: When the tapping key K is pressed, the current in coil C_2 (and the resulting magnetic field) rises from zero to a maximum value in a short time. Consequently, the magnetic flux through the neighbouring coil C_1 also increases. It is the change in magnetic flux through coil C_1 that produces an induced emf in coil C_1 . When the key is held pressed, current in coil C_2 is constant. Therefore, there is no change in the magnetic flux through coil C_1 and the current in coil C_1 drops to zero. When the key is released, the current in C_2 and the resulting magnetic field decreases from the maximum value to zero in a short time. This results in a decrease in magnetic flux through coil C_1 and hence again induces an electric current in coil C_1 *. The common point in all these observations is that the time rate of change of magnetic flux through a circuit induces emf in it. Faraday stated experimental observations in the form of a law called *Faraday's law of electromagnetic induction*. The law is stated below.

* Note that sensitive electrical instruments in the vicinity of an electromagnet can be damaged due to the induced emfs (and the resulting currents) when the electromagnet is turned on or off.

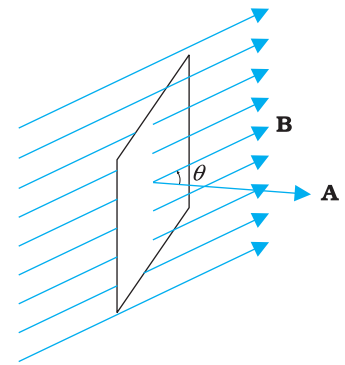

FIGURE 6.4 A plane of surface area A placed in a uniform magnetic field B .

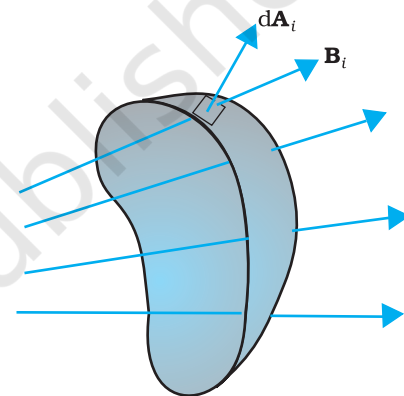

FIGURE 6.5 Magnetic field B_i at the i^{th} area element. $d\mathbf{A}_i$ represents area vector of i^{th} area element.



Michael Faraday [1791–1867] Faraday made numerous contributions to science, viz., the discovery of electromagnetic induction, the laws of electrolysis, benzene, and the fact that the plane of polarisation is rotated in an electric field. He is also credited with the invention of the electric motor, the electric generator and the transformer. He is widely regarded as the greatest experimental scientist of the nineteenth century.

The magnitude of the induced emf in a circuit is equal to the time rate of change of magnetic flux through the circuit.

Mathematically, the induced emf is given by

$$\varepsilon = -\frac{d\Phi_B}{dt} \quad (6.3)$$

The negative sign indicates the direction of ε and hence the direction of current in a closed loop. This will be discussed in detail in the next section.

In the case of a closely wound coil of N turns, change of flux associated with each turn, is the same. Therefore, the expression for the total induced emf is given by

$$\varepsilon = -N \frac{d\Phi_B}{dt} \quad (6.4)$$

The induced emf can be increased by increasing the number of turns N of a closed coil.

From Eqs. (6.1) and (6.2), we see that the flux can be varied by changing any one or more of the terms \mathbf{B} , \mathbf{A} and θ . In Experiments 6.1 and 6.2 in Section 6.2, the flux is changed by varying \mathbf{B} . The flux can also be altered by changing the shape of a coil (that is, by shrinking it or stretching it) in a magnetic field, or rotating a coil in a magnetic field such that the angle θ between \mathbf{B} and \mathbf{A} changes. In these cases too, an emf is induced in the respective coils.

Example 6.1 Consider Experiment 6.2. (a) What would you do to obtain a large deflection of the galvanometer? (b) How would you demonstrate the presence of an induced current in the absence of a galvanometer?

Solution

- (a) To obtain a large deflection, one or more of the following steps can be taken: (i) Use a rod made of soft iron inside the coil C_2 , (ii) Connect the coil to a powerful battery, and (iii) Move the arrangement rapidly towards the test coil C_1 .
- (b) Replace the galvanometer by a small bulb, the kind one finds in a small torch light. The relative motion between the two coils will cause the bulb to glow and thus demonstrate the presence of an induced current.

In experimental physics one must learn to innovate. Michael Faraday who is ranked as one of the best experimentalists ever, was legendary for his innovative skills.

Example 6.2 A square loop of side 10 cm and resistance 0.5Ω is placed vertically in the east-west plane. A uniform magnetic field of 0.10 T is set up across the plane in the north-east direction. The magnetic field is decreased to zero in 0.70 s at a steady rate. Determine the magnitudes of induced emf and current during this time-interval.

Solution The angle θ made by the area vector of the coil with the magnetic field is 45° . From Eq. (6.1), the initial magnetic flux is

$$\begin{aligned}\Phi &= BA \cos \theta \\ &= \frac{0.1 \times 10^{-2}}{\sqrt{2}} \text{ Wb}\end{aligned}$$

Final flux, $\Phi_{\min} = 0$

The change in flux is brought about in 0.70 s. From Eq. (6.3), the magnitude of the induced emf is given by

$$\varepsilon = \frac{|\Delta\Phi_B|}{\Delta t} = \frac{|(\Phi - 0)|}{\Delta t} = \frac{10^{-3}}{\sqrt{2} \times 0.7} = 1.0 \text{ mV}$$

And the magnitude of the current is

$$I = \frac{\varepsilon}{R} = \frac{10^{-3} \text{ V}}{0.5 \Omega} = 2 \text{ mA}$$

Note that the earth's magnetic field also produces a flux through the loop. But it is a steady field (which does not change within the time span of the experiment) and hence does not induce any emf.

EXAMPLE 6.2

Example 6.3

A circular coil of radius 10 cm, 500 turns and resistance 2Ω is placed with its plane perpendicular to the horizontal component of the earth's magnetic field. It is rotated about its vertical diameter through 180° in 0.25 s. Estimate the magnitudes of the emf and current induced in the coil. Horizontal component of the earth's magnetic field at the place is $3.0 \times 10^{-5} \text{ T}$.

Solution

Initial flux through the coil,

$$\begin{aligned}\Phi_{B(\text{initial})} &= BA \cos \theta \\ &= 3.0 \times 10^{-5} \times (\pi \times 10^{-2}) \times \cos 0^\circ \\ &= 3\pi \times 10^{-7} \text{ Wb}\end{aligned}$$

Final flux after the rotation,

$$\begin{aligned}\Phi_{B(\text{final})} &= 3.0 \times 10^{-5} \times (\pi \times 10^{-2}) \times \cos 180^\circ \\ &= -3\pi \times 10^{-7} \text{ Wb}\end{aligned}$$

Therefore, estimated value of the induced emf is,

$$\begin{aligned}\varepsilon &= N \frac{\Delta\Phi}{\Delta t} \\ &= 500 \times (6\pi \times 10^{-7}) / 0.25 \\ &= 3.8 \times 10^{-3} \text{ V}\end{aligned}$$

$$I = \varepsilon / R = 1.9 \times 10^{-3} \text{ A}$$

Note that the magnitudes of ε and I are the estimated values. Their instantaneous values are different and depend upon the speed of rotation at the particular instant.

EXAMPLE 6.3

6.5 LENZ'S LAW AND CONSERVATION OF ENERGY

In 1834, German physicist Heinrich Friedrich Lenz (1804-1865) deduced a rule, known as *Lenz's law* which gives the polarity of the induced emf in a clear and concise fashion. The statement of the law is:

The polarity of induced emf is such that it tends to produce a current which opposes the change in magnetic flux that produced it.

The negative sign shown in Eq. (6.3) represents this effect. We can understand Lenz's law by examining Experiment 6.1 in Section 6.2.1. In Fig. 6.1, we see that the North-pole of a bar magnet is being pushed towards the closed coil. As the North-pole of the bar magnet moves towards the coil, the magnetic flux through the coil increases. Hence current is induced in the coil in such a direction that it opposes the increase in flux. This is possible only if the current in the coil is in a counter-clockwise direction with respect to an observer situated on the side of the magnet. Note that magnetic moment associated with this current has North polarity towards the North-pole of the approaching magnet. Similarly, if the North-pole of the magnet is being withdrawn from the coil, the magnetic flux through the coil will decrease. To counter this decrease in magnetic flux, the induced current in the coil flows in clockwise direction and its South-pole faces the receding North-pole of the bar magnet. This would result in an attractive force which opposes the motion of the magnet and the corresponding decrease in flux.

What will happen if an open circuit is used in place of the closed loop in the above example? In this case too, an emf is induced across the open ends of the circuit. The direction of the induced emf can be found using Lenz's law. Consider Figs. 6.6 (a) and (b). They provide an easier way to understand the direction of induced currents. Note that the direction shown by ↻ and ↻ indicate the directions of the induced currents.

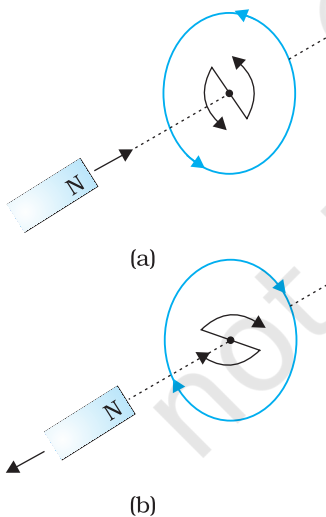

FIGURE 6.6
Illustration of
Lenz's law.

A little reflection on this matter should convince us on the correctness of Lenz's law. Suppose that the induced current was in the direction opposite to the one depicted in Fig. 6.6(a). In that case, the South-pole due to the induced current will face the approaching North-pole of the magnet. The bar magnet will then be attracted towards the coil at an ever increasing acceleration. A gentle push on the magnet will initiate the process and its velocity and kinetic energy will continuously increase without expending any energy. If this can happen, one could construct a perpetual-motion machine by a suitable arrangement. This violates the law of conservation of energy and hence can not happen.

Now consider the correct case shown in Fig. 6.6(a). In this situation, the bar magnet experiences a repulsive force due to the induced current. Therefore, a person has to do work in moving the magnet. Where does the energy spent by the person go? This energy is dissipated by Joule heating produced by the induced current.

Example 6.4

Figure 6.7 shows planar loops of different shapes moving out of or into a region of a magnetic field which is directed normal to the plane of the loop away from the reader. Determine the direction of induced current in each loop using Lenz's law.

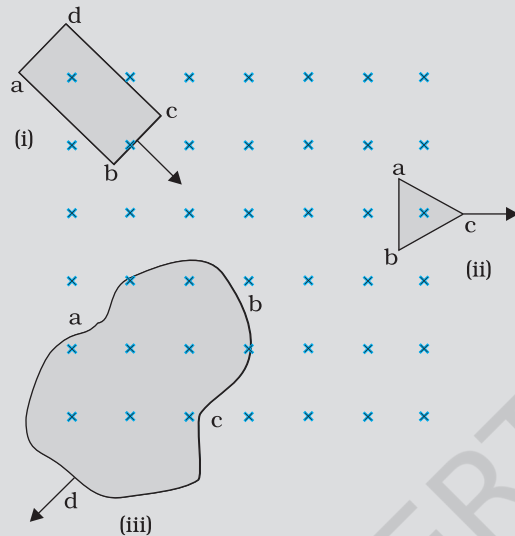

FIGURE 6.7

Solution

- (i) The magnetic flux through the rectangular loop $abcd$ increases, due to the motion of the loop into the region of magnetic field. The induced current must flow along the path $bcadb$ so that it opposes the increasing flux.
 - (ii) Due to the outward motion, magnetic flux through the triangular loop abc decreases due to which the induced current flows along $bacb$, so as to oppose the change in flux.
 - (iii) As the magnetic flux decreases due to motion of the irregular shaped loop $abcd$ out of the region of magnetic field, the induced current flows along $cdabc$, so as to oppose change in flux.
- Note that there are no induced current as long as the loops are completely inside or outside the region of the magnetic field.

EXAMPLE 6.4

Example 6.5

- (a) A closed loop is held stationary in the magnetic field between the north and south poles of two permanent magnets held fixed. Can we hope to generate current in the loop by using very strong magnets?
- (b) A closed loop moves normal to the constant electric field between the plates of a large capacitor. Is a current induced in the loop (i) when it is wholly inside the region between the capacitor plates (ii) when it is partially outside the plates of the capacitor? The electric field is normal to the plane of the loop.
- (c) A rectangular loop and a circular loop are moving out of a uniform magnetic field region (Fig. 6.8) to a field-free region with a *constant velocity* \mathbf{v} . In which loop do you expect the induced emf to be constant *during* the passage out of the field region? The field is normal to the loops.

EXAMPLE 6.5

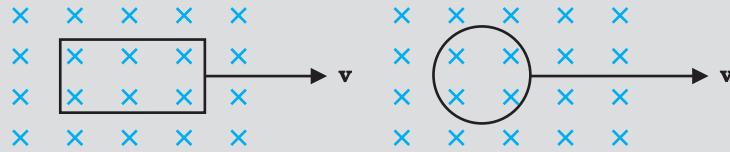

FIGURE 6.8

(d) Predict the polarity of the capacitor in the situation described by Fig. 6.9.

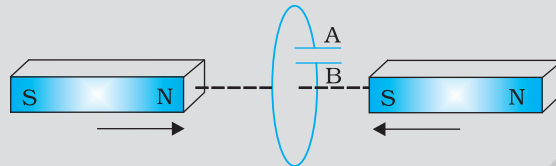

FIGURE 6.9

Solution

- (a) No. However strong the magnet may be, current can be induced only by changing the magnetic flux through the loop.
- (b) No current is induced in *either* case. Current can not be induced by changing the electric flux.
- (c) The induced emf is expected to be constant only in the case of the rectangular loop. In the case of circular loop, the rate of change of area of the loop during its passage out of the field region is not constant, hence induced *emf* will vary accordingly.
- (d) The polarity of plate 'A' will be positive with respect to plate 'B' in the capacitor.

EXAMPLE 6.5

6.6 MOTIONAL ELECTROMOTIVE FORCE

Let us consider a straight conductor moving in a uniform and time-independent magnetic field. Figure 6.10 shows a rectangular conductor PQRS in which the conductor PQ is free to move. The rod PQ is moved

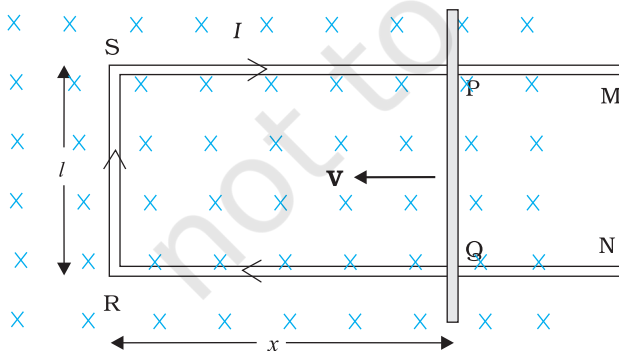

FIGURE 6.10 The arm PQ is moved to the left side, thus decreasing the area of the rectangular loop. This movement induces a current *I* as shown.

towards the left with a constant velocity \mathbf{v} as shown in the figure. Assume that there is no loss of energy due to friction. PQRS forms a closed circuit enclosing an area that changes as PQ moves. It is placed in a uniform magnetic field \mathbf{B} which is perpendicular to the plane of this system. If the length $RQ = x$ and $RS = l$, the magnetic flux Φ_B enclosed by the loop PQRS will be

$$\Phi_B = Blx$$

Since x is changing with time, the rate of change of flux Φ_B will induce an emf given by:

$$\varepsilon = \frac{-d\Phi_B}{dt} = -\frac{d}{dt}(Blx)$$

$$= -Bl \frac{dx}{dt} = Blv \tag{6.5}$$

where we have used $dx/dt = -v$ which is the speed of the conductor PQ. The induced emf Blv is called *motional emf*. Thus, we are able to produce induced emf by moving a conductor instead of varying the magnetic field, that is, by changing the magnetic flux enclosed by the circuit.

It is also possible to explain the motional emf expression in Eq. (6.5) by invoking the Lorentz force acting on the free charge carriers of conductor PQ. Consider any arbitrary charge q in the conductor PQ. When the rod moves with speed v , the charge will also be moving with speed v in the magnetic field \mathbf{B} . The Lorentz force on this charge is qvB in magnitude, and its direction is towards Q. All charges experience the same force, in magnitude and direction, irrespective of their position in the rod PQ. The work done in moving the charge from P to Q is,

$$W = qvBl$$

Since emf is the work done per unit charge,

$$\begin{aligned}\varepsilon &= \frac{W}{q} \\ &= Blv\end{aligned}$$

This equation gives emf induced across the rod PQ and is identical to Eq. (6.5). We stress that our presentation is not wholly rigorous. But it does help us to understand the basis of Faraday's law when the conductor is moving in a uniform and time-independent magnetic field.

On the other hand, it is not obvious how an emf is induced when a conductor is stationary and the magnetic field is changing – a fact which Faraday verified by numerous experiments. In the case of a stationary conductor, the force on its charges is given by

$$\mathbf{F} = q(\mathbf{E} + \mathbf{v} \times \mathbf{B}) = q\mathbf{E} \quad (6.6)$$

since $\mathbf{v} = 0$. Thus, any force on the charge must arise from the electric field term \mathbf{E} alone. Therefore, to explain the existence of induced emf or induced current, we must assume that a time-varying magnetic field generates an electric field. However, we hasten to add that electric fields produced by static electric charges have properties different from those produced by time-varying magnetic fields. In Chapter 4, we learnt that charges in motion (current) can exert force/torque on a stationary magnet. Conversely, a bar magnet in motion (or more generally, a changing magnetic field) can exert a force on the stationary charge. This is the fundamental significance of the Faraday's discovery. Electricity and magnetism are related.

Example 6.6 A metallic rod of 1 m length is rotated with a frequency of 50 rev/s, with one end hinged at the centre and the other end at the circumference of a circular metallic ring of radius 1 m, about an axis passing through the centre and perpendicular to the plane of the ring (Fig. 6.11). A constant and uniform magnetic field of 1 T parallel to the axis is present everywhere. What is the emf between the centre and the metallic ring?

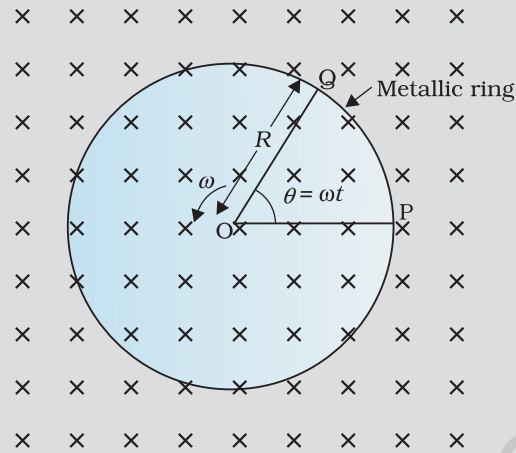

FIGURE 6.11

Solution

Method I

As the rod is rotated, free electrons in the rod move towards the outer end due to Lorentz force and get distributed over the ring. Thus, the resulting separation of charges produces an emf across the ends of the rod. At a certain value of emf, there is no more flow of electrons and a steady state is reached. Using Eq. (6.5), the magnitude of the emf generated across a length dr of the rod as it moves at right angles to the magnetic field is given by

$d\varepsilon = Bv dr$. Hence,

$$\varepsilon = \int_0^R d\varepsilon = \int_0^R Bv dr = \int_0^R B\omega r dr = \frac{B\omega R^2}{2}$$

Note that we have used $v = \omega r$. This gives

$$\begin{aligned} \varepsilon &= \frac{1}{2} \times 1.0 \times 2\pi \times 50 \times (1^2) \\ &= 157 \text{ V} \end{aligned}$$

Method II

To calculate the emf, we can imagine a closed loop OPQ in which point O and P are connected with a resistor R and OQ is the rotating rod. The potential difference across the resistor is then equal to the induced emf and equals $B \times$ (rate of change of area of loop). If θ is the angle between the rod and the radius of the circle at P at time t , the area of the sector OPQ is given by

$$\pi R^2 \times \frac{\theta}{2\pi} = \frac{1}{2} R^2 \theta$$

where R is the radius of the circle. Hence, the induced emf is

$$\varepsilon = B \times \frac{d}{dt} \left[\frac{1}{2} R^2 \theta \right] = \frac{1}{2} BR^2 \frac{d\theta}{dt} = \frac{B\omega R^2}{2}$$

[Note: $\frac{d\theta}{dt} = \omega = 2\pi\nu$]

This expression is identical to the expression obtained by Method I and we get the same value of ε .

EXAMPLE 6.6

Example 6.7

A wheel with 10 metallic spokes each 0.5 m long is rotated with a speed of 120 rev/min in a plane normal to the horizontal component of earth's magnetic field H_E at a place. If $H_E = 0.4$ G at the place, what is the induced emf between the axle and the rim of the wheel? Note that $1 \text{ G} = 10^{-4} \text{ T}$.

Solution

$$\begin{aligned} \text{Induced emf} &= (1/2) \omega B R^2 \\ &= (1/2) \times 4\pi \times 0.4 \times 10^{-4} \times (0.5)^2 \\ &= 6.28 \times 10^{-5} \text{ V} \end{aligned}$$

The number of spokes is immaterial because the emf's across the spokes are *in parallel*.

EXAMPLE 6.7

6.7 INDUCTANCE

An electric current can be induced in a coil by flux change produced by another coil in its vicinity or flux change produced by the same coil. These two situations are described separately in the next two sub-sections. However, in both the cases, the flux through a coil is proportional to the current. That is, $\Phi_B \propto I$.

Further, if the geometry of the coil does not vary with time then,

$$\frac{d\Phi_B}{dt} \propto \frac{dI}{dt}$$

For a closely wound coil of N turns, the same magnetic flux is linked with all the turns. When the flux Φ_B through the coil changes, each turn contributes to the induced emf. Therefore, a term called *flux linkage* is used which is equal to $N\Phi_B$ for a closely wound coil and in such a case

$$N\Phi_B \propto I$$

The constant of proportionality, in this relation, is called *inductance*. We shall see that inductance depends only on the geometry of the coil and intrinsic material properties. This aspect is akin to capacitance which for a parallel plate capacitor depends on the plate area and plate separation (geometry) and the dielectric constant K of the intervening medium (intrinsic material property).

Inductance is a scalar quantity. It has the dimensions of $[ML^2T^{-2}A^{-2}]$ given by the dimensions of flux divided by the dimensions of current. The SI unit of inductance is *henry* and is denoted by H. It is named in honour of Joseph Henry who discovered electromagnetic induction in USA, independently of Faraday in England.

6.7.1 Mutual inductance

Consider Fig. 6.12 which shows two long co-axial solenoids each of length l . We denote the radius of the inner solenoid S_1 by r_1 and the number of turns per unit length by n_1 . The corresponding quantities for the outer solenoid S_2 are r_2 and n_2 , respectively. Let N_1 and N_2 be the total number of turns of coils S_1 and S_2 , respectively.

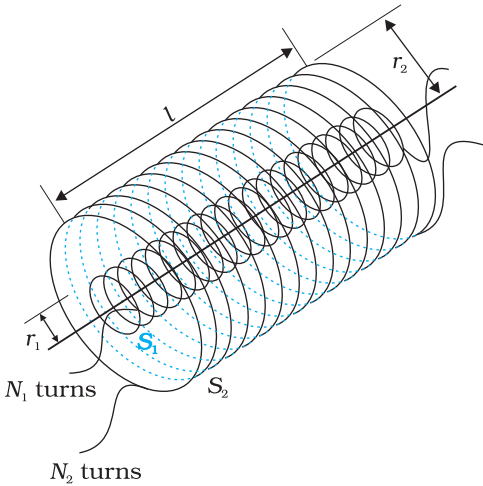

FIGURE 6.12 Two long co-axial solenoids of same length l .

When a current I_2 is set up through S_2 , it in turn sets up a magnetic flux through S_1 . Let us denote it by Φ_1 . The corresponding flux linkage with solenoid S_1 is

$$N_1 \Phi_1 = M_{12} I_2 \quad (6.7)$$

M_{12} is called the *mutual inductance* of solenoid S_1 with respect to solenoid S_2 . It is also referred to as the *coefficient of mutual induction*.

For these simple co-axial solenoids it is possible to calculate M_{12} . The magnetic field due to the current I_2 in S_2 is $\mu_0 n_2 I_2$. The resulting flux linkage with coil S_1 is,

$$\begin{aligned} N_1 \Phi_1 &= (n_1 l) (\pi r_1^2) (\mu_0 n_2 I_2) \\ &= \mu_0 n_1 n_2 \pi r_1^2 l I_2 \end{aligned} \quad (6.8)$$

where $n_1 l$ is the total number of turns in solenoid S_1 . Thus, from Eq. (6.7) and Eq. (6.8),

$$M_{12} = \mu_0 n_1 n_2 \pi r_1^2 l \quad (6.9)$$

Note that we neglected the edge effects and considered the magnetic field $\mu_0 n_2 I_2$ to be uniform throughout the length and width of the solenoid S_2 . This is a good approximation keeping in mind that the solenoid is long, implying $l \gg r_2$.

We now consider the reverse case. A current I_1 is passed through the solenoid S_1 and the flux linkage with coil S_2 is,

$$N_2 \Phi_2 = M_{21} I_1 \quad (6.10)$$

M_{21} is called the *mutual inductance* of solenoid S_2 with respect to solenoid S_1 .

The flux due to the current I_1 in S_1 can be assumed to be confined solely inside S_1 since the solenoids are very long. Thus, flux linkage with solenoid S_2 is

$$N_2 \Phi_2 = (n_2 l) (\pi r_1^2) (\mu_0 n_1 I_1)$$

where $n_2 l$ is the total number of turns of S_2 . From Eq. (6.10),

$$M_{21} = \mu_0 n_1 n_2 \pi r_1^2 l \quad (6.11)$$

Using Eq. (6.9) and Eq. (6.10), we get

$$M_{12} = M_{21} = M \text{ (say)} \quad (6.12)$$

We have demonstrated this equality for long co-axial solenoids. However, the relation is far more general. Note that if the inner solenoid was much shorter than (and placed well inside) the outer solenoid, then we could still have calculated the flux linkage $N_1 \Phi_1$ because the inner solenoid is effectively immersed in a uniform magnetic field due to the outer solenoid. In this case, the calculation of M_{12} would be easy. However, it would be extremely difficult to calculate the flux linkage with the outer solenoid as the magnetic field due to the inner solenoid would vary across the length as well as cross section of the outer solenoid. Therefore, the calculation of M_{21} would also be extremely difficult in this case. The equality $M_{12} = M_{21}$ is very useful in such situations.

We explained the above example with air as the medium within the solenoids. Instead, if a medium of relative permeability μ_r had been present, the mutual inductance would be

$$M = \mu_r \mu_0 n_1 n_2 \pi r_1^2 l$$

It is also important to know that the mutual inductance of a pair of coils, solenoids, etc., depends on their separation as well as their relative orientation.

Example 6.8 Two concentric circular coils, one of small radius r_1 and the other of large radius r_2 , such that $r_1 \ll r_2$, are placed co-axially with centres coinciding. Obtain the mutual inductance of the arrangement.

Solution Let a current I_2 flow through the outer circular coil. The field at the centre of the coil is $B_2 = \mu_0 I_2 / 2r_2$. Since the other co-axially placed coil has a very small radius, B_2 may be considered constant over its cross-sectional area. Hence,

$$\begin{aligned} \Phi_1 &= \pi r_1^2 B_2 \\ &= \frac{\mu_0 \pi r_1^2}{2r_2} I_2 \\ &= M_{12} I_2 \end{aligned}$$

Thus,

$$M_{12} = \frac{\mu_0 \pi r_1^2}{2r_2}$$

From Eq. (6.12)

$$M_{12} = M_{21} = \frac{\mu_0 \pi r_1^2}{2r_2}$$

Note that we calculated M_{12} from an approximate value of Φ_1 , assuming the magnetic field B_2 to be uniform over the area πr_1^2 . However, we can accept this value because $r_1 \ll r_2$.

EXAMPLE 6.8

Now, let us recollect Experiment 6.3 in Section 6.2. In that experiment, emf is induced in coil C_1 wherever there was any change in current through coil C_2 . Let Φ_1 be the flux through coil C_1 (say of N_1 turns) when current in coil C_2 is I_2 .

Then, from Eq. (6.7), we have

$$N_1 \Phi_1 = M I_2$$

For currents varying with time,

$$\frac{d(N_1 \Phi_1)}{dt} = \frac{d(M I_2)}{dt}$$

Since induced emf in coil C_1 is given by

$$\varepsilon_1 = - \frac{d(N_1 \Phi_1)}{dt}$$

We get,

$$\varepsilon_1 = -M \frac{dI_2}{dt}$$

It shows that varying current in a coil can induce emf in a neighbouring coil. The magnitude of the induced emf depends upon the rate of change of current and mutual inductance of the two coils.

6.7.2 Self-inductance

In the previous sub-section, we considered the flux in one solenoid due to the current in the other. It is also possible that emf is induced in a single isolated coil due to change of flux through the coil by means of varying the current through the same coil. This phenomenon is called *self-induction*. In this case, flux linkage through a coil of N turns is proportional to the current through the coil and is expressed as

$$N\Phi_B \propto I$$

$$N\Phi_B = LI \quad (6.13)$$

where constant of proportionality L is called *self-inductance* of the coil. It is also called the *coefficient of self-induction* of the coil. When the current is varied, the flux linked with the coil also changes and an emf is induced in the coil. Using Eq. (6.13), the induced emf is given by

$$\varepsilon = -\frac{d(N\Phi_B)}{dt}$$

$$\varepsilon = -L \frac{dI}{dt} \quad (6.14)$$

Thus, the self-induced emf always opposes any change (increase or decrease) of current in the coil.

It is possible to calculate the self-inductance for circuits with simple geometries. Let us calculate the self-inductance of a long solenoid of cross-sectional area A and length l , having n turns per unit length. The magnetic field due to a current I flowing in the solenoid is $B = \mu_0 n I$ (neglecting edge effects, as before). The total flux linked with the solenoid is

$$N\Phi_B = (nl)(\mu_0 n I)(A)$$

$$= \mu_0 n^2 Al$$

where nl is the total number of turns. Thus, the self-inductance is,

$$L = \frac{N\Phi_B}{I}$$

$$= \mu_0 n^2 Al \quad (6.15)$$

If we fill the inside of the solenoid with a material of relative permeability μ_r (for example soft iron, which has a high value of relative permeability), then,

$$L = \mu_r \mu_0 n^2 Al \quad (6.16)$$

The self-inductance of the coil depends on its geometry and on the permeability of the medium.

The self-induced emf is also called the *back emf* as it opposes any change in the current in a circuit. Physically, the *self-inductance plays*

the role of inertia. It is the electromagnetic analogue of mass in mechanics. So, work needs to be done against the back emf (\mathcal{E}) in establishing the current. This work done is stored as magnetic potential energy. For the current I at an instant in a circuit, the rate of work done is

$$\frac{dW}{dt} = |\mathcal{E}|I$$

If we ignore the resistive losses and consider only inductive effect, then using Eq. (6.14),

$$\frac{dW}{dt} = L I \frac{dI}{dt}$$

Total amount of work done in establishing the current I is

$$W = \int dW = \int_0^I L I dI$$

Thus, the energy required to build up the current I is,

$$W = \frac{1}{2} L I^2 \quad (6.17)$$

This expression reminds us of $mv^2/2$ for the (mechanical) kinetic energy of a particle of mass m , and shows that L is analogous to m (i.e., L is electrical inertia and opposes growth and decay of current in the circuit).

Consider the general case of currents flowing simultaneously in two nearby coils. The flux linked with one coil will be the sum of two fluxes which exist independently. Equation (6.7) would be modified into

$$N_1 \Phi_1 = M_{11} I_1 + M_{12} I_2$$

where M_{11} represents inductance due to the same coil.

Therefore, using Faraday's law,

$$\mathcal{E}_1 = -M_{11} \frac{dI_1}{dt} - M_{12} \frac{dI_2}{dt}$$

M_{11} is the *self-inductance* and is written as L_1 . Therefore,

$$\mathcal{E}_1 = -L_1 \frac{dI_1}{dt} - M_{12} \frac{dI_2}{dt}$$

Example 6.9 (a) Obtain the expression for the magnetic energy stored in a solenoid in terms of magnetic field B , area A and length l of the solenoid. (b) How does this magnetic energy compare with the electrostatic energy stored in a capacitor?

Solution

(a) From Eq. (6.17), the magnetic energy is

$$\begin{aligned} U_B &= \frac{1}{2} L I^2 \\ &= \frac{1}{2} L \left(\frac{B}{\mu_0 n} \right)^2 \quad (\text{since } B = \mu_0 n I, \text{ for a solenoid}) \end{aligned}$$

Interactive animation on ac generator:
<http://micro.magnet.fsu.edu/electromag/java/generator/ac.html>

PHYSICS

EXAMPLE 6.9

$$= \frac{1}{2} (\mu_0 n^2 Al) \left(\frac{B}{\mu_0 n} \right)^2 \quad \text{[from Eq. (6.15)]}$$

$$= \frac{1}{2\mu_0} B^2 Al$$

(b) The magnetic energy per unit volume is,

$$\begin{aligned} u_B &= \frac{U_B}{V} && \text{(where } V \text{ is volume that contains flux)} \\ &= \frac{U_B}{Al} \\ &= \frac{B^2}{2\mu_0} \end{aligned} \quad (6.18)$$

We have already obtained the relation for the electrostatic energy stored per unit volume in a parallel plate capacitor (refer to Chapter 2, Eq. 2.73),

$$u_E = \frac{1}{2} \epsilon_0 E^2 \quad (2.73)$$

In both the cases energy is proportional to the square of the field strength. Equations (6.18) and (2.73) have been derived for special cases: a solenoid and a parallel plate capacitor, respectively. But they are general and valid for any region of space in which a magnetic field or/and an electric field exist.

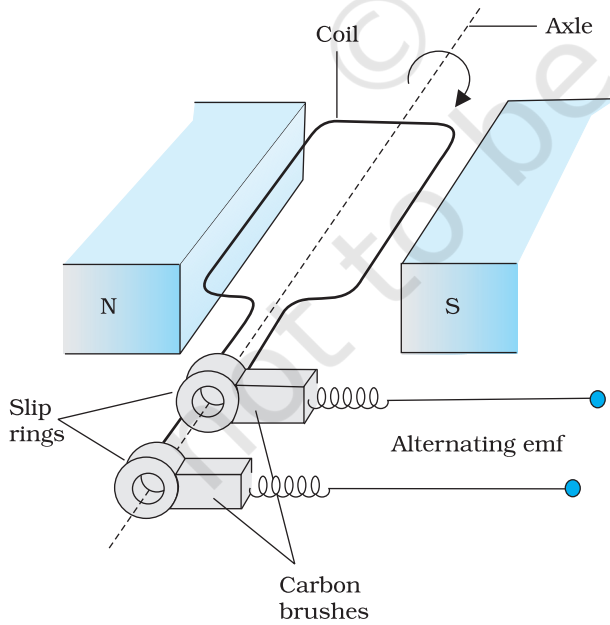

FIGURE 6.13 AC Generator

6.8 AC GENERATOR

The phenomenon of electromagnetic induction has been technologically exploited in many ways. An exceptionally important application is the generation of alternating currents (ac). The modern ac generator with a typical output capacity of 100 MW is a highly evolved machine. In this section, we shall describe the basic principles behind this machine. The Yugoslav inventor Nicola Tesla is credited with the development of the machine. As was pointed out in Section 6.3, one method to induce an emf or current in a loop is through a change in the loop's orientation or a change in its effective area. As the coil rotates in a magnetic field **B**, the effective area of the loop (the face perpendicular to the field) is $A \cos \theta$, where θ is the angle between **A** and **B**. This method of producing a flux change is the principle of operation of a

simple ac generator. An ac generator converts mechanical energy into electrical energy.

The basic elements of an ac generator are shown in Fig. 6.13. It consists of a coil mounted on a rotor shaft. The axis of rotation of the coil is perpendicular to the direction of the magnetic field. The coil (called armature) is mechanically rotated in the uniform magnetic field by some external means. The rotation of the coil causes the magnetic flux through it to change, so an emf is induced in the coil. The ends of the coil are connected to an external circuit by means of slip rings and brushes.

When the coil is rotated with a constant angular speed ω , the angle θ between the magnetic field vector \mathbf{B} and the area vector \mathbf{A} of the coil at any instant t is $\theta = \omega t$ (assuming $\theta = 0^\circ$ at $t = 0$). As a result, the effective area of the coil exposed to the magnetic field lines changes with time, and from Eq. (6.1), the flux at any time t is

$$\Phi_B = BA \cos \theta = BA \cos \omega t$$

From Faraday's law, the induced emf for the rotating coil of N turns is then,

$$\varepsilon = -N \frac{d\Phi_B}{dt} = -NBA \frac{d}{dt}(\cos \omega t)$$

Thus, the instantaneous value of the emf is

$$\varepsilon = NBA \omega \sin \omega t \quad (6.19)$$

where $NBA\omega$ is the maximum value of the emf, which occurs when $\sin \omega t = \pm 1$. If we denote $NBA\omega$ as ε_0 , then

$$\varepsilon = \varepsilon_0 \sin \omega t \quad (6.20)$$

Since the value of the sine function varies between +1 and -1, the sign, or polarity of the emf changes with time. Note from Fig. 6.14 that the emf has its extremum value when $\theta = 90^\circ$ or $\theta = 270^\circ$, as the change of flux is greatest at these points.

The direction of the current changes periodically and therefore the current is called *alternating current* (ac). Since $\omega = 2\pi\nu$, Eq (6.20) can be written as

$$\varepsilon = \varepsilon_0 \sin 2\pi \nu t \quad (6.21)$$

where ν is the frequency of revolution of the generator's coil.

Note that Eq. (6.20) and (6.21) give the instantaneous value of the emf and ε varies between $+\varepsilon_0$ and $-\varepsilon_0$ periodically. We shall learn how to determine the time-averaged value for the alternating voltage and current in the next chapter.

In commercial generators, the mechanical energy required for rotation of the armature is provided by water falling from a height, for example, from dams. These are called *hydro-electric generators*. Alternatively, water is heated to produce steam using coal or other sources. The steam at high pressure produces the rotation of the armature. These are called *thermal generators*. Instead of coal, if a nuclear fuel is used, we get *nuclear power generators*. Modern day generators produce electric power as high as 500 MW, i.e., one can light

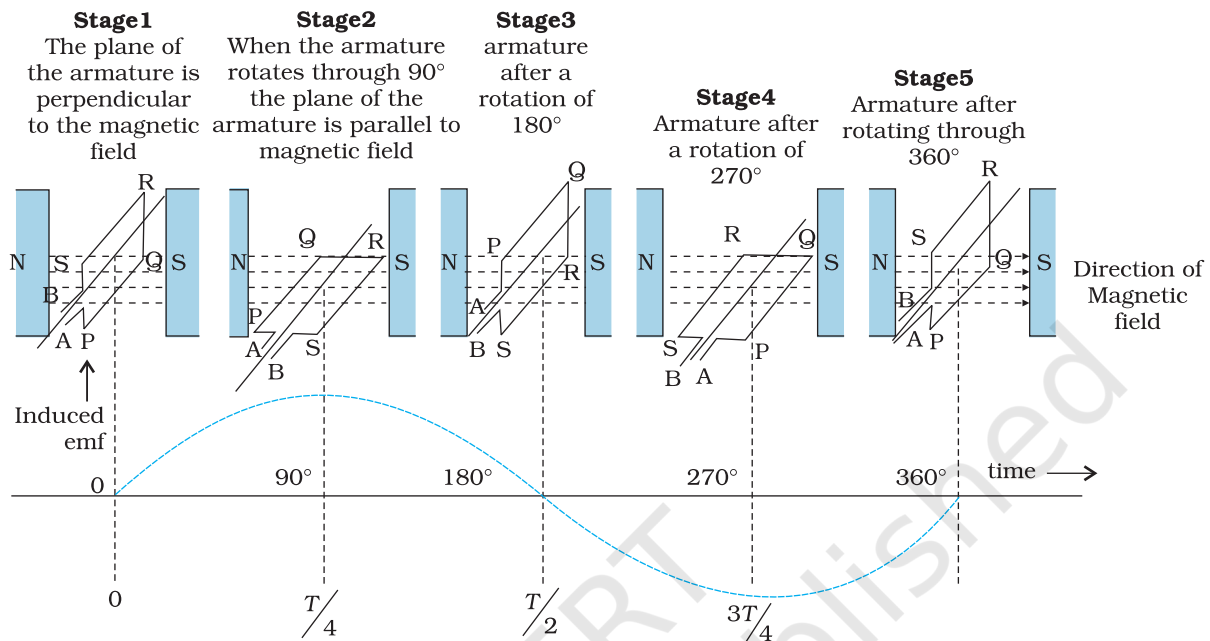

FIGURE 6.14 An alternating emf is generated by a loop of wire rotating in a magnetic field.

up to 5 million 100 W bulbs! In most generators, the coils are held stationary and it is the electromagnets which are rotated. The frequency of rotation is 50 Hz in India. In certain countries such as USA, it is 60 Hz.

EXAMPLE 6.10

Example 6.10 Kamla peddles a stationary bicycle. The pedals of the bicycle are attached to a 100 turn coil of area 0.10 m^2 . The coil rotates at half a revolution per second and it is placed in a uniform magnetic field of 0.01 T perpendicular to the axis of rotation of the coil. What is the maximum voltage generated in the coil?

Solution Here $\nu = 0.5 \text{ Hz}$; $N = 100$, $A = 0.1 \text{ m}^2$ and $B = 0.01 \text{ T}$. Employing Eq. (6.19)

$$\begin{aligned} \varepsilon_0 &= NBA (2 \pi \nu) \\ &= 100 \times 0.01 \times 0.1 \times 2 \times 3.14 \times 0.5 \\ &= 0.314 \text{ V} \end{aligned}$$

The maximum voltage is 0.314 V .

We urge you to explore such alternative possibilities for power generation.

SUMMARY

- The magnetic flux through a surface of area \mathbf{A} placed in a uniform magnetic field \mathbf{B} is defined as,

$$\Phi_B = \mathbf{B} \cdot \mathbf{A} = BA \cos \theta$$

where θ is the angle between \mathbf{B} and \mathbf{A} .

- Faraday's laws of induction imply that the emf induced in a coil of N turns is directly related to the rate of change of flux through it,

$$\mathcal{E} = -N \frac{d\Phi_B}{dt}$$

Here Φ_B is the flux linked with one turn of the coil. If the circuit is closed, a current $I = \mathcal{E}/R$ is set up in it, where R is the resistance of the circuit.

- Lenz's law states that the polarity of the induced emf is such that it tends to produce a current which opposes the change in magnetic flux that produces it. The negative sign in the expression for Faraday's law indicates this fact.
- When a metal rod of length l is placed normal to a uniform magnetic field B and moved with a velocity v perpendicular to the field, the induced emf (called motional emf) across its ends is

$$\mathcal{E} = Blv$$

- Inductance is the ratio of the flux-linkage to current. It is equal to $N\Phi/I$.
- A changing current in a coil (coil 2) can induce an emf in a nearby coil (coil 1). This relation is given by,

$$\mathcal{E}_1 = -M_{12} \frac{dI_2}{dt}$$

The quantity M_{12} is called mutual inductance of coil 1 with respect to coil 2. One can similarly define M_{21} . There exists a general equality,

$$M_{12} = M_{21}$$

- When a current in a coil changes, it induces a back emf in the same coil. The self-induced emf is given by,

$$\mathcal{E} = -L \frac{dI}{dt}$$

L is the self-inductance of the coil. It is a measure of the inertia of the coil against the change of current through it.

- The self-inductance of a long solenoid, the core of which consists of a magnetic material of relative permeability μ_r , is given by

$$L = \mu_r \mu_0 n^2 Al$$

where A is the area of cross-section of the solenoid, l its length and n the number of turns per unit length.

- In an ac generator, mechanical energy is converted to electrical energy by virtue of electromagnetic induction. If coil of N turn and area A is rotated at ν revolutions per second in a uniform magnetic field B , then the motional emf produced is

$$\mathcal{E} = NBA (2\pi\nu) \sin (2\pi\nu t)$$

where we have assumed that at time $t = 0$ s, the coil is perpendicular to the field.

Quantity	Symbol	Units	Dimensions	Equations
Magnetic Flux	Φ_B	Wb (weber)	$[ML^2T^{-2}A^{-1}]$	$\Phi_B = \mathbf{B} \cdot \mathbf{A}$
EMF	ε	V (volt)	$[ML^2T^{-3}A^{-1}]$	$\varepsilon = -d(N\Phi_B) / dt$
Mutual Inductance	M	H (henry)	$[ML^2T^{-2}A^{-2}]$	$\varepsilon_1 = -M_{12} (dI_2 / dt)$
Self Inductance	L	H (henry)	$[ML^2T^{-2}A^{-2}]$	$\varepsilon = -L (dI / dt)$

POINTS TO PONDER

1. Electricity and magnetism are intimately related. In the early part of the nineteenth century, the experiments of Oersted, Ampere and others established that moving charges (currents) produce a magnetic field. Somewhat later, around 1830, the experiments of Faraday and Henry demonstrated that a moving magnet can induce electric current.
2. In a closed circuit, electric currents are induced so as to oppose the changing magnetic flux. It is as per the law of conservation of energy. However, in case of an open circuit, an emf is induced across its ends. How is it related to the flux change?
3. The motional emf discussed in Section 6.5 can be argued independently from Faraday's law using the Lorentz force on moving charges. However, even if the charges are stationary [and the $q(\mathbf{v} \times \mathbf{B})$ term of the Lorentz force is not operative], an emf is nevertheless induced in the presence of a time-varying magnetic field. Thus, moving charges in static field and static charges in a time-varying field seem to be symmetric situation for Faraday's law. This gives a tantalising hint on the relevance of the principle of relativity for Faraday's law.

EXERCISES

- 6.1** Predict the direction of induced current in the situations described by the following Figs. 6.15(a) to (f).

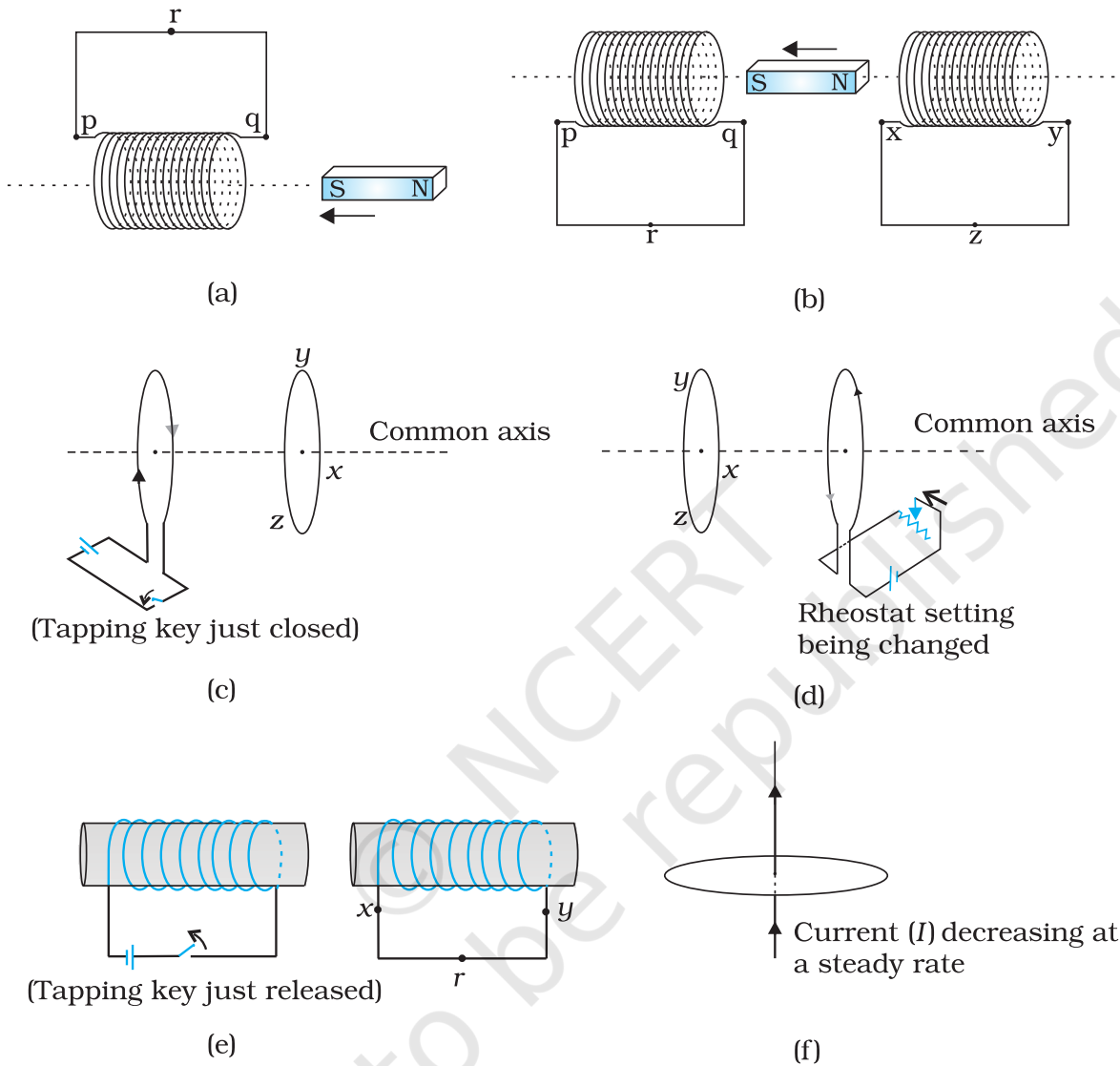

FIGURE 6.15

6.2 Use Lenz's law to determine the direction of induced current in the situations described by Fig. 6.16:

- (a) A wire of irregular shape turning into a circular shape;

(b) A circular loop being deformed into a narrow straight wire.

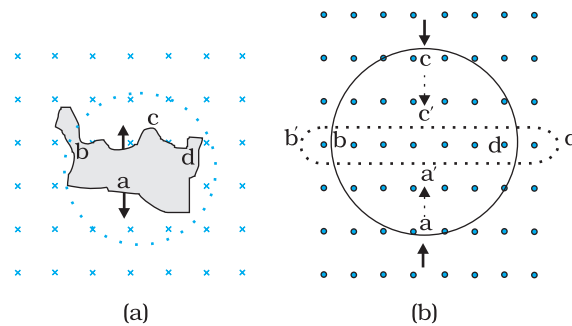
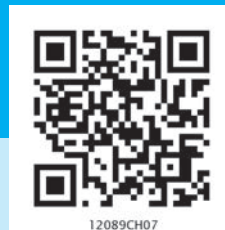

FIGURE 6.16

- 6.3** A long solenoid with 15 turns per cm has a small loop of area 2.0 cm^2 placed inside the solenoid normal to its axis. If the current carried by the solenoid changes steadily from 2.0 A to 4.0 A in 0.1 s , what is the induced emf in the loop while the current is changing?
- 6.4** A rectangular wire loop of sides 8 cm and 2 cm with a small cut is moving out of a region of uniform magnetic field of magnitude 0.3 T directed normal to the loop. What is the emf developed across the cut if the velocity of the loop is 1 cm s^{-1} in a direction normal to the (a) longer side, (b) shorter side of the loop? For how long does the induced voltage last in each case?
- 6.5** A 1.0 m long metallic rod is rotated with an angular frequency of 400 rad s^{-1} about an axis normal to the rod passing through its one end. The other end of the rod is in contact with a circular metallic ring. A constant and uniform magnetic field of 0.5 T parallel to the axis exists everywhere. Calculate the emf developed between the centre and the ring.
- 6.6** A horizontal straight wire 10 m long extending from east to west is falling with a speed of 5.0 m s^{-1} , at right angles to the horizontal component of the earth's magnetic field, $0.30 \times 10^{-4} \text{ Wb m}^{-2}$.
 (a) What is the instantaneous value of the emf induced in the wire?
 (b) What is the direction of the emf?
 (c) Which end of the wire is at the higher electrical potential?
- 6.7** Current in a circuit falls from 5.0 A to 0.0 A in 0.1 s . If an average emf of 200 V induced, give an estimate of the self-inductance of the circuit.
- 6.8** A pair of adjacent coils has a mutual inductance of 1.5 H . If the current in one coil changes from 0 to 20 A in 0.5 s , what is the change of flux linkage with the other coil?



Chapter Seven

ALTERNATING CURRENT

7.1 INTRODUCTION

We have so far considered direct current (dc) sources and circuits with dc sources. These currents do not change direction with time. But voltages and currents that vary with time are very common. The electric mains supply in our homes and offices is a voltage that varies like a sine function with time. Such a voltage is called *alternating voltage* (ac voltage) and the current driven by it in a circuit is called the *alternating current* (ac current)*. Today, most of the electrical devices we use require ac voltage. This is mainly because most of the electrical energy sold by power companies is transmitted and distributed as alternating current. The main reason for preferring use of ac voltage over dc voltage is that ac voltages can be easily and efficiently converted from one voltage to the other by means of transformers. Further, electrical energy can also be transmitted economically over long distances. AC circuits exhibit characteristics which are exploited in many devices of daily use. For example, whenever we tune our radio to a favourite station, we are taking advantage of a special property of ac circuits – one of many that you will study in this chapter.

* The phrases *ac voltage* and *ac current* are contradictory and redundant, respectively, since they mean, literally, *alternating current voltage* and *alternating current current*. Still, the abbreviation *ac* to designate an electrical quantity displaying simple harmonic time dependence has become so universally accepted that we follow others in its use. Further, *voltage* – another phrase commonly used means potential difference between two points.

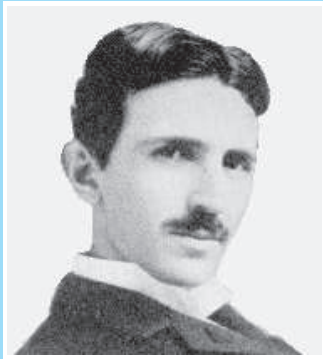

Nicola Tesla (1856 – 1943) Serbian-American scientist, inventor and genius. He conceived the idea of the rotating magnetic field, which is the basis of practically all alternating current machinery, and which helped usher in the age of electric power. He also invented among other things the induction motor, the polyphase system of ac power, and the high frequency induction coil (the Tesla coil) used in radio and television sets and other electronic equipment. The SI unit of magnetic field is named in his honour.

7.2 AC VOLTAGE APPLIED TO A RESISTOR

Figure 7.1 shows a resistor connected to a source ε of ac voltage. The symbol for an ac source in a circuit diagram is \ominus . We consider a source which produces sinusoidally varying potential difference across its terminals. Let this potential difference, also called ac voltage, be given by

$$v = v_m \sin \omega t \quad (7.1)$$

where v_m is the amplitude of the oscillating potential difference and ω is its angular frequency.



FIGURE 7.1 AC voltage applied to a resistor.

To find the value of current through the resistor, we apply Kirchhoff's loop rule $\sum \varepsilon(t) = 0$ (refer to Section 3.12), to the circuit shown in Fig. 7.1 to get

$$v_m \sin \omega t = iR$$

$$\text{or } i = \frac{v_m}{R} \sin \omega t$$

Since R is a constant, we can write this equation as

$$i = i_m \sin \omega t \quad (7.2)$$

where the current amplitude i_m is given by

$$i_m = \frac{v_m}{R} \quad (7.3)$$

Equation (7.3) is Ohm's law, which for resistors, works equally well for both ac and dc voltages. The voltage across a pure resistor and the current through it, given by Eqs. (7.1) and (7.2) are plotted as a function of time in Fig. 7.2. Note, in particular that both v and i reach zero, minimum and maximum values at the same time. Clearly, *the voltage and current are in phase with each other.*

We see that, like the applied voltage, the current varies sinusoidally and has corresponding positive and negative values during each cycle. Thus, the sum of the instantaneous current values over one complete cycle is zero, and the average current is zero. The fact that the average current is zero, however, does

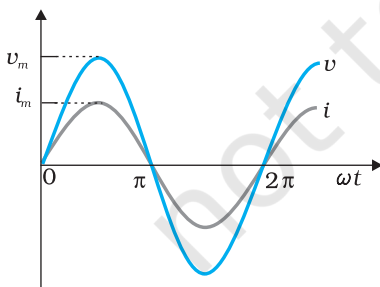

FIGURE 7.2 In a pure resistor, the voltage and current are in phase. The minima, zero and maxima occur at the same respective times.

not mean that the average power consumed is zero and that there is no dissipation of electrical energy. As you know, Joule heating is given by $i^2 R$ and depends on i^2 (which is always positive whether i is positive or negative) and not on i . Thus, there is Joule heating and dissipation of electrical energy when an ac current passes through a resistor.

The instantaneous power dissipated in the resistor is

$$p = i^2 R = i_m^2 R \sin^2 \omega t \quad (7.4)$$

The average value of p over a cycle is*

$$\bar{p} = \langle i^2 R \rangle = \langle i_m^2 R \sin^2 \omega t \rangle \quad (7.5(a))$$

where the bar over a letter (here, p) denotes its average value and $\langle \dots \rangle$ denotes taking average of the quantity inside the bracket. Since, i_m^2 and R are constants,

$$\bar{p} = i_m^2 R \langle \sin^2 \omega t \rangle \quad (7.5(b))$$

Using the trigonometric identity, $\sin^2 \omega t = 1/2 (1 - \cos 2\omega t)$, we have $\langle \sin^2 \omega t \rangle = (1/2) (1 - \langle \cos 2\omega t \rangle)$ and since $\langle \cos 2\omega t \rangle = 0^{**}$, we have,

$$\langle \sin^2 \omega t \rangle = \frac{1}{2}$$

Thus,

$$\bar{p} = \frac{1}{2} i_m^2 R \quad (7.5(c))$$

To express ac power in the same form as dc power ($P = I^2 R$), a special value of current is defined and used. It is called, *root mean square (rms)* or *effective current* (Fig. 7.3) and is denoted by I_{rms} or I .

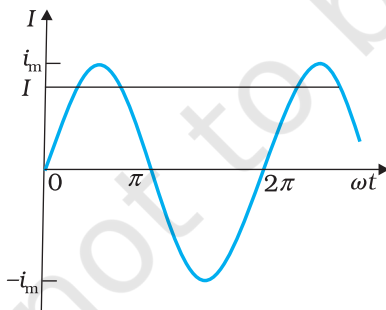
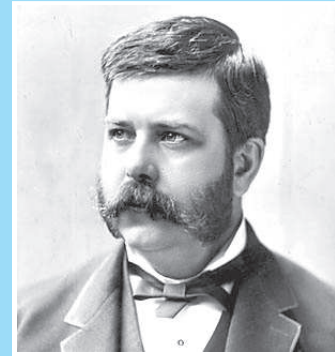

FIGURE 7.3 The rms current I is related to the peak current i_m by $I = i_m / \sqrt{2} = 0.707 i_m$.

* The average value of a function $F(t)$ over a period T is given by $\langle F(t) \rangle = \frac{1}{T} \int_0^T F(t) dt$

** $\langle \cos 2\omega t \rangle = \frac{1}{T} \int_0^T \cos 2\omega t dt = \frac{1}{T} \left[\frac{\sin 2\omega t}{2\omega} \right]_0^T = \frac{1}{2\omega T} [\sin 2\omega T - 0] = 0$



George Westinghouse (1846 - 1914)

A leading proponent of the use of alternating current over direct current. Thus, he came into conflict with Thomas Alva Edison, an advocate of direct current. Westinghouse was convinced that the technology of alternating current was the key to the electrical future. He founded the famous Company named after him and enlisted the services of Nicola Tesla and other inventors in the development of alternating current motors and apparatus for the transmission of high tension current, pioneering in large scale lighting.

GEORGE WESTINGHOUSE (1846 - 1914)

It is defined by

$$I = \sqrt{i^2} = \sqrt{\frac{1}{2} i_m^2} = \frac{i_m}{\sqrt{2}} = 0.707 i_m \quad (7.6)$$

In terms of I , the average power, denoted by P is

$$P = \bar{p} = \frac{1}{2} i_m^2 R = I^2 R \quad (7.7)$$

Similarly, we define the *rms voltage* or *effective voltage* by

$$V = \frac{v_m}{\sqrt{2}} = 0.707 v_m \quad (7.8)$$

From Eq. (7.3), we have

$$v_m = i_m R$$

or, $\frac{v_m}{\sqrt{2}} = \frac{i_m}{\sqrt{2}} R$

or, $V = IR \quad (7.9)$

Equation (7.9) gives the relation between ac current and ac voltage and is similar to that in the dc case. This shows the advantage of introducing the concept of rms values. In terms of rms values, the equation for power [Eq. (7.7)] and relation between current and voltage in ac circuits are essentially the same as those for the dc case.

It is customary to measure and specify rms values for ac quantities. For example, the household line voltage of 220 V is an rms value with a peak voltage of

$$v_m = \sqrt{2} V = (1.414)(220 \text{ V}) = 311 \text{ V}$$

In fact, the I or rms current is the equivalent dc current that would produce the same average power loss as the alternating current. Equation (7.7) can also be written as

$$P = V^2 / R = IV \quad (\text{since } V = IR)$$

EXAMPLE 7.1

Example 7.1 A light bulb is rated at 100W for a 220 V supply. Find (a) the resistance of the bulb; (b) the peak voltage of the source; and (c) the rms current through the bulb.

Solution

(a) We are given $P = 100 \text{ W}$ and $V = 220 \text{ V}$. The resistance of the bulb is

$$R = \frac{V^2}{P} = \frac{(220 \text{ V})^2}{100 \text{ W}} = 484 \Omega$$

(b) The peak voltage of the source is

$$v_m = \sqrt{2} V = 311 \text{ V}$$

(c) Since, $P = IV$

$$I = \frac{P}{V} = \frac{100 \text{ W}}{220 \text{ V}} = 0.454 \text{ A}$$

7.3 REPRESENTATION OF AC CURRENT AND VOLTAGE BY ROTATING VECTORS — PHASORS

In the previous section, we learnt that the current through a resistor is in phase with the ac voltage. But this is not so in the case of an inductor, a capacitor or a combination of these circuit elements. In order to show phase relationship between voltage and current in an ac circuit, we use the notion of *phasors*. The analysis of an ac circuit is facilitated by the use of a phasor diagram. A phasor* is a vector which rotates about the origin with angular speed ω , as shown in Fig. 7.4. The vertical components of phasors \mathbf{V} and \mathbf{I} represent the sinusoidally varying quantities v and i . The magnitudes of phasors \mathbf{V} and \mathbf{I} represent the amplitudes or the peak values v_m and i_m of these oscillating quantities. Figure 7.4(a) shows the voltage and current phasors and their relationship at time t_1 for the case of an ac source connected to a resistor i.e., corresponding to the circuit shown in Fig. 7.1. The projection of voltage and current phasors on vertical axis, i.e., $v_m \sin \omega t$ and $i_m \sin \omega t$, respectively represent the value of voltage and current at that instant. As they rotate with frequency ω , curves in Fig. 7.4(b) are generated. From Fig. 7.4(a) we see that phasors \mathbf{V} and \mathbf{I} for the case of a resistor are in the same direction. This is so for all times. This means that the phase angle between the voltage and the current is zero.

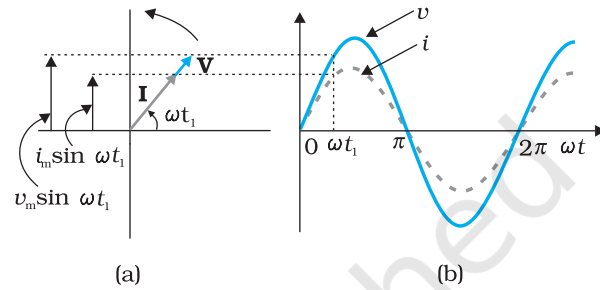

FIGURE 7.4 (a) A phasor diagram for the circuit in Fig 7.1. (b) Graph of v and i versus ωt .

7.4 AC VOLTAGE APPLIED TO AN INDUCTOR

Figure 7.5 shows an ac source connected to an inductor. Usually, inductors have appreciable resistance in their windings, but we shall assume that this inductor has negligible resistance. Thus, the circuit is a purely inductive ac circuit. Let the voltage across the source be $v = v_m \sin \omega t$. Using the Kirchhoff's loop rule, $\sum \varepsilon(t) = 0$, and since there is no resistor in the circuit,

$$v - L \frac{di}{dt} = 0 \tag{7.10}$$

where the second term is the self-induced Faraday emf in the inductor; and L is the self-inductance of

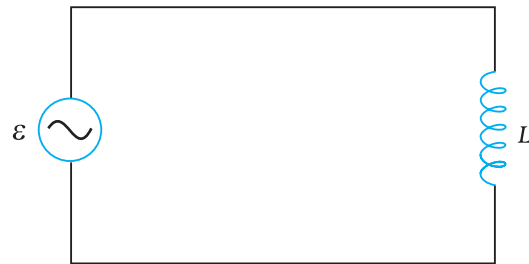

FIGURE 7.5 An ac source connected to an inductor.

* Though voltage and current in ac circuit are represented by phasors – rotating vectors, they are not vectors themselves. They are scalar quantities. It so happens that the amplitudes and phases of harmonically varying scalars combine mathematically in the same way as do the projections of rotating vectors of corresponding magnitudes and directions. The *rotating vectors* that *represent* harmonically varying scalar quantities are introduced only to provide us with a simple way of adding these quantities using a rule that we already know.



the inductor. The negative sign follows from Lenz's law (Chapter 6). Combining Eqs. (7.1) and (7.10), we have

$$\frac{di}{dt} = \frac{v}{L} = \frac{v_m}{L} \sin \omega t \tag{7.11}$$

Equation (7.11) implies that the equation for $i(t)$, the current as a function of time, must be such that its slope di/dt is a sinusoidally varying quantity, with the same phase as the source voltage and an amplitude given by v_m/L . To obtain the current, we integrate di/dt with respect to time:

$$\int \frac{di}{dt} dt = \frac{v_m}{L} \int \sin(\omega t) dt$$

and get,

$$i = -\frac{v_m}{\omega L} \cos(\omega t) + \text{constant}$$

The integration constant has the dimension of current and is time-independent. Since the source has an emf which oscillates symmetrically about zero, the current it sustains also oscillates symmetrically about zero, so that no constant or time-independent component of the current exists. Therefore, the integration constant is zero.

Using

$$-\cos(\omega t) = \sin\left(\omega t - \frac{\pi}{2}\right), \text{ we have}$$

$$i = i_m \sin\left(\omega t - \frac{\pi}{2}\right) \tag{7.12}$$

where $i_m = \frac{v_m}{\omega L}$ is the amplitude of the current. The quantity ωL is analogous to the resistance and is called *inductive reactance*, denoted by X_L :

$$X_L = \omega L \tag{7.13}$$

The amplitude of the current is, then

$$i_m = \frac{v_m}{X_L} \tag{7.14}$$

The dimension of inductive reactance is the same as that of resistance and its SI unit is ohm (Ω). The inductive reactance limits the current in a purely inductive circuit in the same way as the resistance limits the current in a purely resistive circuit. The inductive reactance is directly proportional to the inductance and to the frequency of the current.

A comparison of Eqs. (7.1) and (7.12) for the source voltage and the current in an inductor shows that the current lags the voltage by $\pi/2$ or one-quarter ($1/4$) cycle. Figure 7.6 (a) shows the voltage and the current phasors in the present case at instant t_1 . The current phasor \mathbf{I} is $\pi/2$ behind the voltage phasor \mathbf{V} . When rotated with frequency ω counter-clockwise, they generate the voltage and current given by Eqs. (7.1) and (7.12), respectively and as shown in Fig. 7.6(b).

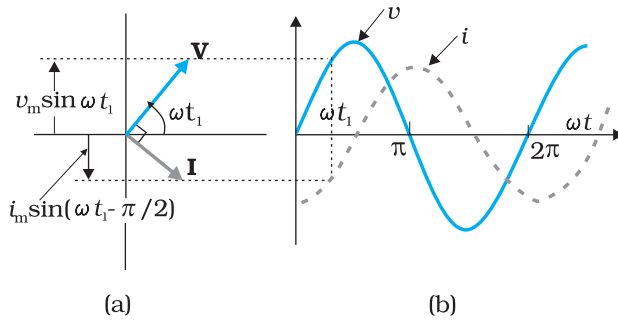

FIGURE 7.6 (a) A Phasor diagram for the circuit in Fig. 7.5.
(b) Graph of v and i versus ωt .

We see that the current reaches its maximum value later than the voltage by one-fourth of a period $\left[\frac{T}{4} = \frac{\pi/2}{\omega}\right]$. You have seen that an inductor has reactance that limits current similar to resistance in a dc circuit. Does it also consume power like a resistance? Let us try to find out.

The instantaneous power supplied to the inductor is

$$\begin{aligned} p_L &= i v = i_m \sin\left(\omega t - \frac{\pi}{2}\right) \times v_m \sin(\omega t) \\ &= -i_m v_m \cos(\omega t) \sin(\omega t) \\ &= -\frac{i_m v_m}{2} \sin(2\omega t) \end{aligned}$$

So, the average power over a complete cycle is

$$\begin{aligned} P_L &= \left\langle -\frac{i_m v_m}{2} \sin(2\omega t) \right\rangle \\ &= -\frac{i_m v_m}{2} \langle \sin(2\omega t) \rangle = 0, \end{aligned}$$

since the average of $\sin(2\omega t)$ over a complete cycle is zero.

Thus, the average power supplied to an inductor over one complete cycle is zero.

Example 7.2 A pure inductor of 25.0 mH is connected to a source of 220 V. Find the inductive reactance and rms current in the circuit if the frequency of the source is 50 Hz.

Solution The inductive reactance,

$$\begin{aligned} X_L &= 2\pi\nu L = 2 \times 3.14 \times 50 \times 25 \times 10^{-3} \Omega \\ &= 7.85 \Omega \end{aligned}$$

The rms current in the circuit is

$$I = \frac{V}{X_L} = \frac{220 \text{ V}}{7.85 \Omega} = 28 \text{ A}$$

7.5 AC VOLTAGE APPLIED TO A CAPACITOR

Figure 7.7 shows an ac source ε generating ac voltage $v = v_m \sin \omega t$ connected to a capacitor only, a purely capacitive ac circuit.

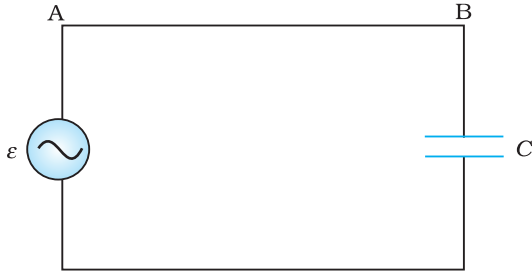

FIGURE 7.7 An ac source connected to a capacitor.

When a capacitor is connected to a voltage source in a dc circuit, current will flow for the short time required to charge the capacitor. As charge accumulates on the capacitor plates, the voltage across them increases, opposing the current. That is, a capacitor in a dc circuit will limit or oppose the current as it charges. When the capacitor is fully charged, the current in the circuit falls to zero.

When the capacitor is connected to an ac source, as in Fig. 7.7, it limits or regulates the current, but does not completely prevent the flow of charge. The capacitor is alternately charged and discharged as the current reverses each half cycle. Let q be the

charge on the capacitor at any time t . The instantaneous voltage v across the capacitor is

$$v = \frac{q}{C} \quad (7.15)$$

From the Kirchhoff's loop rule, the voltage across the source and the capacitor are equal,

$$v_m \sin \omega t = \frac{q}{C}$$

To find the current, we use the relation $i = \frac{dq}{dt}$

$$i = \frac{d}{dt}(v_m C \sin \omega t) = \omega C v_m \cos(\omega t)$$

Using the relation, $\cos(\omega t) = \sin\left(\omega t + \frac{\pi}{2}\right)$, we have

$$i = i_m \sin\left(\omega t + \frac{\pi}{2}\right) \quad (7.16)$$

where the amplitude of the oscillating current is $i_m = \omega C v_m$. We can rewrite it as

$$i_m = \frac{v_m}{(1/\omega C)}$$

Comparing it to $i_m = v_m/R$ for a purely resistive circuit, we find that $(1/\omega C)$ plays the role of resistance. It is called *capacitive reactance* and is denoted by X_c ,

$$X_c = 1/\omega C \quad (7.17)$$

so that the amplitude of the current is

$$i_m = \frac{v_m}{X_c} \quad (7.18)$$

Alternating Current

The dimension of capacitive reactance is the same as that of resistance and its SI unit is ohm (Ω). The capacitive reactance limits the amplitude of the current in a purely capacitive circuit in the same way as the resistance limits the current in a purely resistive circuit. But it is inversely proportional to the frequency and the capacitance.

A comparison of Eq. (7.16) with the equation of source voltage, Eq. (7.1) shows that the current is $\pi/2$ ahead of voltage.

Figure 7.8(a) shows the phasor diagram at an instant t_1 . Here the current phasor \mathbf{I} is $\pi/2$ ahead of the voltage phasor \mathbf{V} as they rotate counterclockwise. Figure 7.8(b) shows the variation of voltage and current with time. We see that the current reaches its maximum value earlier than the voltage by one-fourth of a period.

The instantaneous power supplied to the capacitor is

$$\begin{aligned} p_c &= i v = i_m \cos(\omega t) v_m \sin(\omega t) \\ &= i_m v_m \cos(\omega t) \sin(\omega t) \\ &= \frac{i_m v_m}{2} \sin(2\omega t) \end{aligned} \quad (7.19)$$

So, as in the case of an inductor, the average power

$$P_C = \left\langle \frac{i_m v_m}{2} \sin(2\omega t) \right\rangle = \frac{i_m v_m}{2} \langle \sin(2\omega t) \rangle = 0$$

since $\langle \sin(2\omega t) \rangle = 0$ over a complete cycle.

Thus, we see that in the case of an inductor, the current lags the voltage by $\pi/2$ and in the case of a capacitor, the current leads the voltage by $\pi/2$.

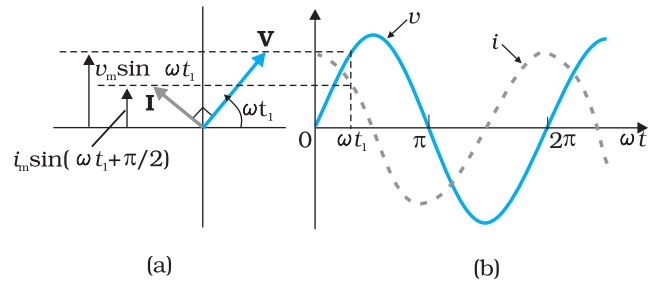

FIGURE 7.8 (a) A Phasor diagram for the circuit in Fig. 7.7. (b) Graph of v and i versus ωt .

Example 7.3 A lamp is connected in series with a capacitor. Predict your observations for dc and ac connections. What happens in each case if the capacitance of the capacitor is reduced?

Solution When a dc source is connected to a capacitor, the capacitor gets charged and after charging no current flows in the circuit and the lamp will not glow. There will be no change even if C is reduced. With ac source, the capacitor offers capacitive reactance ($1/\omega C$) and the current flows in the circuit. Consequently, the lamp will shine. Reducing C will increase reactance and the lamp will shine less brightly than before.

EXAMPLE 7.3

Example 7.4 A $15.0 \mu\text{F}$ capacitor is connected to a 220 V , 50 Hz source. Find the capacitive reactance and the current (rms and peak) in the circuit. If the frequency is doubled, what happens to the capacitive reactance and the current?

Solution The capacitive reactance is

$$X_C = \frac{1}{2\pi\nu C} = \frac{1}{2\pi(50\text{Hz})(15.0 \times 10^{-6}\text{F})} = 212 \Omega$$

The rms current is

EXAMPLE 7.4

EXAMPLE 7.4

$$I = \frac{V}{X_C} = \frac{220 \text{ V}}{212 \ \Omega} = 1.04 \text{ A}$$

The peak current is

$$i_m = \sqrt{2}I = (1.41)(1.04 \text{ A}) = 1.47 \text{ A}$$

This current oscillates between +1.47A and -1.47 A, and is ahead of the voltage by $\pi/2$.

If the frequency is doubled, the capacitive reactance is halved and consequently, the current is doubled.

EXAMPLE 7.5

Example 7.5 A light bulb and an open coil inductor are connected to an ac source through a key as shown in Fig. 7.9.

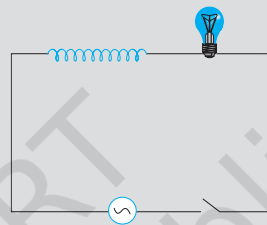

FIGURE 7.9

The switch is closed and after sometime, an iron rod is inserted into the interior of the inductor. The glow of the light bulb (a) increases; (b) decreases; (c) is unchanged, as the iron rod is inserted. Give your answer with reasons.

Solution As the iron rod is inserted, the magnetic field inside the coil magnetizes the iron increasing the magnetic field inside it. Hence, the inductance of the coil increases. Consequently, the inductive reactance of the coil increases. As a result, a larger fraction of the applied ac voltage appears across the inductor, leaving less voltage across the bulb. Therefore, the glow of the light bulb decreases.

7.6 AC VOLTAGE APPLIED TO A SERIES LCR CIRCUIT

Figure 7.10 shows a series LCR circuit connected to an ac source ε . As usual, we take the voltage of the source to be $v = v_m \sin \omega t$.

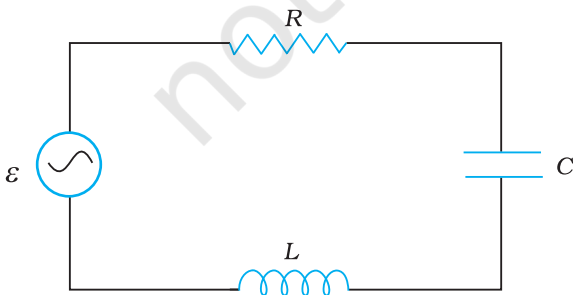

FIGURE 7.10 A series LCR circuit connected to an ac source.

If q is the charge on the capacitor and i the current, at time t , we have, from Kirchhoff's loop rule:

$$L \frac{di}{dt} + iR + \frac{q}{C} = v \tag{7.20}$$

We want to determine the instantaneous current i and its phase relationship to the applied alternating voltage v . We shall solve this problem by two methods. First, we use the technique of phasors and in the second method, we solve Eq. (7.20) analytically to obtain the time-dependence of i .

7.6.1 Phasor-diagram solution

From the circuit shown in Fig. 7.10, we see that the resistor, inductor and capacitor are in series. Therefore, the ac current in each element is the same at any time, having the same amplitude and phase. Let it be

$$i = i_m \sin(\omega t + \phi) \quad (7.21)$$

where ϕ is the phase difference between the voltage across the source and the current in the circuit. On the basis of what we have learnt in the previous sections, we shall construct a phasor diagram for the present case.

Let \mathbf{I} be the phasor representing the current in the circuit as given by Eq. (7.21). Further, let \mathbf{V}_L , \mathbf{V}_R , \mathbf{V}_C , and \mathbf{V} represent the voltage across the inductor, resistor, capacitor and the source, respectively. From previous section, we know that \mathbf{V}_R is parallel to \mathbf{I} , \mathbf{V}_C is $\pi/2$ behind \mathbf{I} and \mathbf{V}_L is $\pi/2$ ahead of \mathbf{I} . \mathbf{V}_L , \mathbf{V}_R , \mathbf{V}_C and \mathbf{I} are shown in Fig. 7.11(a) with appropriate phase-relations.

The length of these phasors or the amplitude of \mathbf{V}_R , \mathbf{V}_C and \mathbf{V}_L are:

$$v_{Rm} = i_m R, v_{Cm} = i_m X_C, v_{Lm} = i_m X_L \quad (7.22)$$

The voltage Equation (7.20) for the circuit can be written as

$$v_L + v_R + v_C = v \quad (7.23)$$

The phasor relation whose vertical component gives the above equation is

$$\mathbf{V}_L + \mathbf{V}_R + \mathbf{V}_C = \mathbf{V} \quad (7.24)$$

This relation is represented in Fig. 7.11(b). Since \mathbf{V}_C and \mathbf{V}_L are always along the same line and in opposite directions, they can be combined into a single phasor $(\mathbf{V}_C + \mathbf{V}_L)$ which has a magnitude $|v_{Cm} - v_{Lm}|$. Since \mathbf{V} is represented as the hypotenuse of a right-triangle whose sides are \mathbf{V}_R and $(\mathbf{V}_C + \mathbf{V}_L)$, the pythagorean theorem gives:

$$v_m^2 = v_{Rm}^2 + (v_{Cm} - v_{Lm})^2$$

Substituting the values of v_{Rm} , v_{Cm} , and v_{Lm} from Eq. (7.22) into the above equation, we have

$$\begin{aligned} v_m^2 &= (i_m R)^2 + (i_m X_C - i_m X_L)^2 \\ &= i_m^2 [R^2 + (X_C - X_L)^2] \end{aligned}$$

$$\text{or, } i_m = \frac{v_m}{\sqrt{R^2 + (X_C - X_L)^2}} \quad (7.25(a))$$

By analogy to the resistance in a circuit, we introduce the *impedance* Z in an ac circuit:

$$i_m = \frac{v_m}{Z} \quad (7.25(b))$$

$$\text{where } Z = \sqrt{R^2 + (X_C - X_L)^2} \quad (7.26)$$

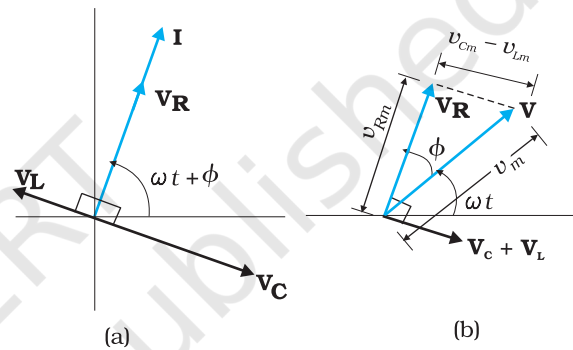

FIGURE 7.11 (a) Relation between the phasors \mathbf{V}_L , \mathbf{V}_R , \mathbf{V}_C , and \mathbf{I} , (b) Relation between the phasors \mathbf{V}_L , \mathbf{V}_R , and $(\mathbf{V}_L + \mathbf{V}_C)$ for the circuit in Fig. 7.10.

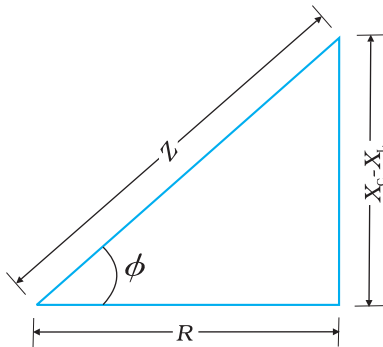

FIGURE 7.12 Impedance diagram.

Since phasor \mathbf{I} is always parallel to phasor \mathbf{V}_R , the phase angle ϕ is the angle between \mathbf{V}_R and \mathbf{V} and can be determined from Fig. 7.12:

$$\tan \phi = \frac{v_{Cm} - v_{Lm}}{v_{Rm}}$$

Using Eq. (7.22), we have

$$\tan \phi = \frac{X_C - X_L}{R} \quad (7.27)$$

Equations (7.26) and (7.27) are graphically shown in Fig. (7.12). This is called *Impedance diagram* which is a right-triangle with Z as its hypotenuse.

Equation 7.25(a) gives the amplitude of the current and Eq. (7.27) gives the phase angle. With these, Eq. (7.21) is completely specified.

If $X_C > X_L$, ϕ is positive and the circuit is predominantly capacitive. Consequently, the current in the circuit leads the source voltage. If $X_C < X_L$, ϕ is negative and the circuit is predominantly inductive. Consequently, the current in the circuit lags the source voltage.

Figure 7.13 shows the phasor diagram and variation of v and i with ωt for the case $X_C > X_L$.

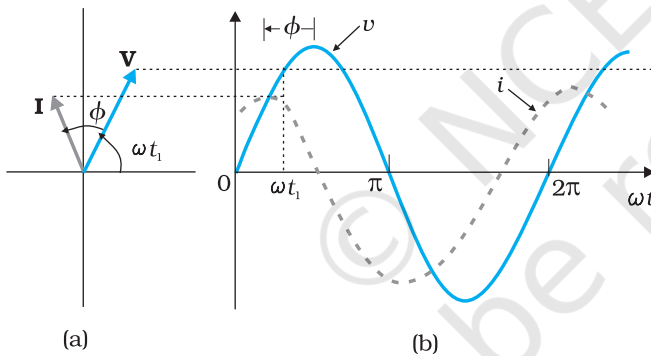

FIGURE 7.13 (a) Phasor diagram of \mathbf{V} and \mathbf{I} .
(b) Graphs of v and i versus ωt for a series LCR circuit where $X_C > X_L$.

Thus, we have obtained the amplitude and phase of current for an LCR series circuit using the technique of phasors. But this method of analysing ac circuits suffers from certain disadvantages. First, the phasor diagram says nothing about the initial condition. One can take any arbitrary value of t (say, t_1 , as done throughout this chapter) and draw different phasors which show the relative angle between different phasors. The solution so obtained is called the *steady-state solution*. This is not a general solution. Additionally, we do have a *transient solution* which exists even for $v = 0$. The general solution is the sum of the transient solution and the steady-state solution.

After a sufficiently long time, the effects of the transient solution die out and the behaviour of the circuit is described by the steady-state solution.

7.6.2 Resonance

An interesting characteristic of the series RLC circuit is the phenomenon of resonance. The phenomenon of resonance is common among systems that have a tendency to oscillate at a particular frequency. This frequency is called the system's *natural frequency*. If such a system is driven by an energy source at a frequency that is near the natural frequency, the amplitude of oscillation is found to be large. A familiar example of this phenomenon is a child on a swing. The swing has a natural frequency for swinging back and forth like a pendulum. If the child pulls on the

rope at regular intervals and the frequency of the pulls is almost the same as the frequency of swinging, the amplitude of the swinging will be large (Chapter 13, Class XI).

For an RLC circuit driven with voltage of amplitude v_m and frequency ω , we found that the current amplitude is given by

$$i_m = \frac{v_m}{Z} = \frac{v_m}{\sqrt{R^2 + (X_C - X_L)^2}}$$

with $X_C = 1/\omega C$ and $X_L = \omega L$. So if ω is varied, then at a particular frequency ω_0 , $X_C = X_L$, and the impedance is minimum ($Z = \sqrt{R^2 + 0^2} = R$). This frequency is called the *resonant frequency*:

$$X_C = X_L \text{ or } \frac{1}{\omega_0 C} = \omega_0 L$$

$$\text{or } \omega_0 = \frac{1}{\sqrt{LC}} \quad (7.28)$$

At resonant frequency, the current amplitude is maximum; $i_m = v_m/R$.

Figure 7.16 shows the variation of i_m with ω in a RLC series circuit with $L = 1.00$ mH, $C = 1.00$ nF for two values of R : (i) $R = 100$ Ω and (ii) $R = 200$ Ω . For the source applied $v_m =$

100 V. ω_0 for this case is $\frac{1}{\sqrt{LC}} = 1.00 \times 10^6$ rad/s.

We see that the current amplitude is maximum at the resonant frequency. Since $i_m = v_m/R$ at resonance, the current amplitude for case (i) is twice to that for case (ii).

Resonant circuits have a variety of applications, for example, in the tuning mechanism of a radio or a TV set. The antenna of a radio accepts signals from many broadcasting stations. The signals picked up in the antenna acts as a source in the tuning circuit of the radio, so the circuit can be driven at many frequencies. But to hear one particular radio station, we tune the radio. In tuning, we vary the capacitance of a capacitor in the tuning circuit such that the resonant frequency of the circuit becomes nearly equal to the frequency of the radio signal received. When this happens, the amplitude of the current with the frequency of the signal of the particular radio station in the circuit is maximum.

It is important to note that resonance phenomenon is exhibited by a circuit only if both L and C are present in the circuit. Only then do the voltages across L and C cancel each other (both being out of phase) and the current amplitude is v_m/R , the total source voltage appearing across R . This means that we cannot have resonance in a RL or RC circuit.

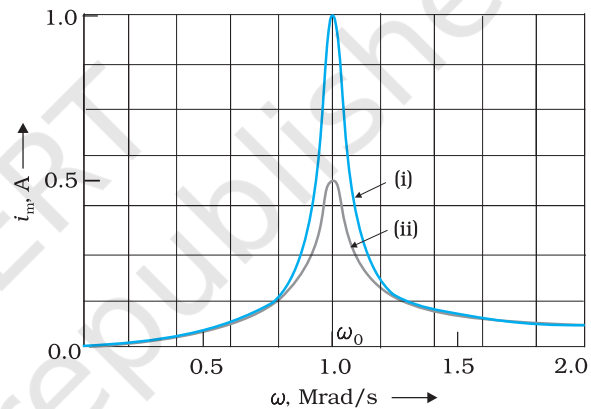

FIGURE 7.14 Variation of i_m with ω for two cases: (i) $R = 100$ Ω , (ii) $R = 200$ Ω , $L = 1.00$ mH.

Example 7.6 A resistor of $200\ \Omega$ and a capacitor of $15.0\ \mu\text{F}$ are connected in series to a $220\ \text{V}$, $50\ \text{Hz}$ ac source. (a) Calculate the current in the circuit; (b) Calculate the voltage (rms) across the resistor and the capacitor. Is the algebraic sum of these voltages more than the source voltage? If yes, resolve the paradox.

Solution

Given

$$R = 200\ \Omega, C = 15.0\ \mu\text{F} = 15.0 \times 10^{-6}\ \text{F}$$

$$V = 220\ \text{V}, \nu = 50\ \text{Hz}$$

(a) In order to calculate the current, we need the impedance of the circuit. It is

$$\begin{aligned} Z &= \sqrt{R^2 + X_C^2} = \sqrt{R^2 + (2\pi\nu C)^{-2}} \\ &= \sqrt{(200\ \Omega)^2 + (2 \times 3.14 \times 50 \times 15.0 \times 10^{-6}\ \text{F})^{-2}} \\ &= \sqrt{(200\ \Omega)^2 + (212.3\ \Omega)^2} \\ &= 291.67\ \Omega \end{aligned}$$

Therefore, the current in the circuit is

$$I = \frac{V}{Z} = \frac{220\ \text{V}}{291.5\ \Omega} = 0.755\ \text{A}$$

(b) Since the current is the same throughout the circuit, we have

$$V_R = IR = (0.755\ \text{A})(200\ \Omega) = 151\ \text{V}$$

$$V_C = IX_C = (0.755\ \text{A})(212.3\ \Omega) = 160.3\ \text{V}$$

The algebraic sum of the two voltages, V_R and V_C is $311.3\ \text{V}$ which is more than the source voltage of $220\ \text{V}$. How to resolve this paradox? As you have learnt in the text, the two voltages are not in the same phase. Therefore, *they cannot be added like ordinary numbers*. The two voltages are out of phase by ninety degrees. Therefore, the total of these voltages must be obtained using the Pythagorean theorem:

$$\begin{aligned} V_{R+C} &= \sqrt{V_R^2 + V_C^2} \\ &= 220\ \text{V} \end{aligned}$$

Thus, if the phase difference between two voltages is properly taken into account, the total voltage across the resistor and the capacitor is equal to the voltage of the source.

EXAMPLE 7.6

7.7 POWER IN AC CIRCUIT: THE POWER FACTOR

We have seen that a voltage $v = v_m \sin\omega t$ applied to a series RLC circuit drives a current in the circuit given by $i = i_m \sin(\omega t + \phi)$ where

$$i_m = \frac{v_m}{Z} \quad \text{and} \quad \phi = \tan^{-1}\left(\frac{X_C - X_L}{R}\right)$$

Therefore, the instantaneous power p supplied by the source is

$$\begin{aligned}
 p &= v i = (v_m \sin \omega t) \times [i_m \sin(\omega t + \phi)] \\
 &= \frac{v_m i_m}{2} [\cos \phi - \cos(2\omega t + \phi)] \qquad (7.29)
 \end{aligned}$$

The average power over a cycle is given by the average of the two terms in R.H.S. of Eq. (7.29). It is only the second term which is time-dependent. Its average is zero (the positive half of the cosine cancels the negative half). Therefore,

$$\begin{aligned}
 P &= \frac{v_m i_m}{2} \cos \phi = \frac{v_m}{\sqrt{2}} \frac{i_m}{\sqrt{2}} \cos \phi \\
 &= V I \cos \phi \qquad [7.30(a)]
 \end{aligned}$$

This can also be written as,

$$P = I^2 Z \cos \phi \qquad [7.30(b)]$$

So, the average power dissipated depends not only on the voltage and current but also on the cosine of the phase angle ϕ between them. The quantity $\cos \phi$ is called the *power factor*. Let us discuss the following cases:

Case (i) Resistive circuit: If the circuit contains only pure R , it is called *resistive*. In that case $\phi = 0$, $\cos \phi = 1$. There is maximum power dissipation.

Case (ii) Purely inductive or capacitive circuit: If the circuit contains only an inductor or capacitor, we know that the phase difference between voltage and current is $\pi/2$. Therefore, $\cos \phi = 0$, and no power is dissipated even though a current is flowing in the circuit. This current is sometimes referred to as *wattless current*.

Case (iii) LCR series circuit: In an LCR series circuit, power dissipated is given by Eq. (7.30) where $\phi = \tan^{-1} (X_c - X_L) / R$. So, ϕ may be non-zero in a RL or RC or RCL circuit. Even in such cases, power is dissipated only in the resistor.

Case (iv) Power dissipated at resonance in LCR circuit: At resonance $X_c - X_L = 0$, and $\phi = 0$. Therefore, $\cos \phi = 1$ and $P = I^2 Z = I^2 R$. That is, maximum power is dissipated in a circuit (through R) at resonance.

Example 7.7 (a) For circuits used for transporting electric power, a low power factor implies large power loss in transmission. Explain.

(b) Power factor can often be improved by the use of a capacitor of appropriate capacitance in the circuit. Explain.

Solution (a) We know that $P = I V \cos \phi$ where $\cos \phi$ is the power factor. To supply a given power at a given voltage, if $\cos \phi$ is small, we have to increase current accordingly. But this will lead to large power loss ($I^2 R$) in transmission.

(b) Suppose in a circuit, current I lags the voltage by an angle ϕ . Then power factor $\cos \phi = R/Z$.

We can improve the power factor (tending to 1) by making Z tend to R . Let us understand, with the help of a phasor diagram (Fig. 7.15)

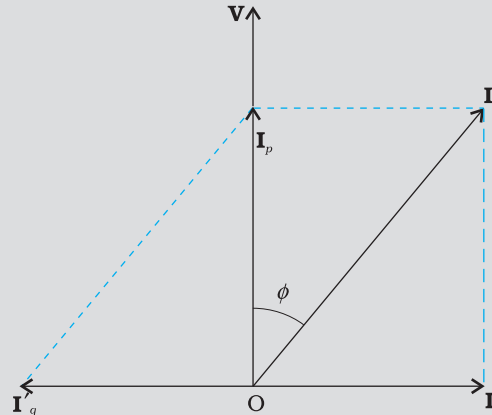

FIGURE 7.15

EXAMPLE 7.7

how this can be achieved. Let us resolve \mathbf{I} into two components. \mathbf{I}_p along the applied voltage \mathbf{V} and \mathbf{I}_q perpendicular to the applied voltage. \mathbf{I}_q as you have learnt in Section 7.7, is called the wattless component since corresponding to this component of current, there is no power loss. \mathbf{I}_p is known as the power component because it is in phase with the voltage and corresponds to power loss in the circuit.

It's clear from this analysis that if we want to improve power factor, we must completely neutralize the lagging wattless current \mathbf{I}_q by an equal leading wattless current \mathbf{I}'_q . This can be done by connecting a capacitor of appropriate value in parallel so that \mathbf{I}_q and \mathbf{I}'_q cancel each other and P is effectively $I_p V$.

EXAMPLE 7.8

Example 7.8 A sinusoidal voltage of peak value 283 V and frequency 50 Hz is applied to a series LCR circuit in which $R = 3 \Omega$, $L = 25.48 \text{ mH}$, and $C = 796 \mu\text{F}$. Find (a) the impedance of the circuit; (b) the phase difference between the voltage across the source and the current; (c) the power dissipated in the circuit; and (d) the power factor.

Solution

(a) To find the impedance of the circuit, we first calculate X_L and X_C .

$$X_L = 2\pi\nu L = 2 \times 3.14 \times 50 \times 25.48 \times 10^{-3} \Omega = 8 \Omega$$

$$X_C = \frac{1}{2\pi\nu C}$$

$$= \frac{1}{2 \times 3.14 \times 50 \times 796 \times 10^{-6}} = 4\Omega$$

Therefore,

$$Z = \sqrt{R^2 + (X_L - X_C)^2} = \sqrt{3^2 + (8 - 4)^2} = 5 \Omega$$

(b) Phase difference, $\phi = \tan^{-1} \frac{X_C - X_L}{R}$

$$= \tan^{-1} \left(\frac{4 - 8}{3} \right) = -53.1^\circ$$

Since ϕ is negative, the current in the circuit lags the voltage across the source.

- (c) The power dissipated in the circuit is

$$P = I^2 R$$

$$\text{Now, } I = \frac{i_m}{\sqrt{2}} = \frac{1}{\sqrt{2}} \left(\frac{283}{5} \right) = 40 \text{ A}$$

$$\text{Therefore, } P = (40 \text{ A})^2 \times 3 \Omega = 4800 \text{ W}$$

- (d) Power factor = $\cos \phi = \cos(-53.1^\circ) = 0.6$

EXAMPLE 7.8

Example 7.9 Suppose the frequency of the source in the previous example can be varied. (a) What is the frequency of the source at which resonance occurs? (b) Calculate the impedance, the current, and the power dissipated at the resonant condition.

Solution

- (a) The frequency at which the resonance occurs is

$$\begin{aligned} \omega_0 &= \frac{1}{\sqrt{LC}} = \frac{1}{\sqrt{25.48 \times 10^{-3} \times 796 \times 10^{-6}}} \\ &= 222.1 \text{ rad/s} \end{aligned}$$

$$v_r = \frac{\omega_0}{2\pi} = \frac{221.1}{2 \times 3.14} \text{ Hz} = 35.4 \text{ Hz}$$

- (b) The impedance Z at resonant condition is equal to the resistance:

$$Z = R = 3 \Omega$$

The rms current at resonance is

$$= \frac{V}{Z} = \frac{V}{R} = \left(\frac{283}{\sqrt{2}} \right) \frac{1}{3} = 66.7 \text{ A}$$

The power dissipated at resonance is

$$P = I^2 \times R = (66.7)^2 \times 3 = 13.35 \text{ kW}$$

You can see that in the present case, power dissipated at resonance is more than the power dissipated in Example 7.8.

EXAMPLE 7.9

Example 7.10 At an airport, a person is made to walk through the doorway of a metal detector, for security reasons. If she/he is carrying anything made of metal, the metal detector emits a sound. On what principle does this detector work?

Solution The metal detector works on the principle of resonance in ac circuits. When you walk through a metal detector, you are, in fact, walking through a coil of many turns. The coil is connected to a capacitor tuned so that the circuit is in resonance. When you walk through with metal in your pocket, the impedance of the circuit changes – resulting in significant change in current in the circuit. This change in current is detected and the electronic circuitry causes a sound to be emitted as an alarm.

EXAMPLE 7.10

7.8 TRANSFORMERS

For many purposes, it is necessary to change (or transform) an alternating voltage from one to another of greater or smaller value. This is done with a device called *transformer* using the principle of mutual induction.

A transformer consists of two sets of coils, insulated from each other. They are wound on a soft-iron core, either one on top of the other as in Fig. 7.16(a) or on separate limbs of the core as in Fig. 7.16(b). One of the coils called the *primary coil* has N_p turns. The other coil is called the *secondary coil*; it has N_s turns. Often the primary coil is the input coil and the secondary coil is the output coil of the transformer.

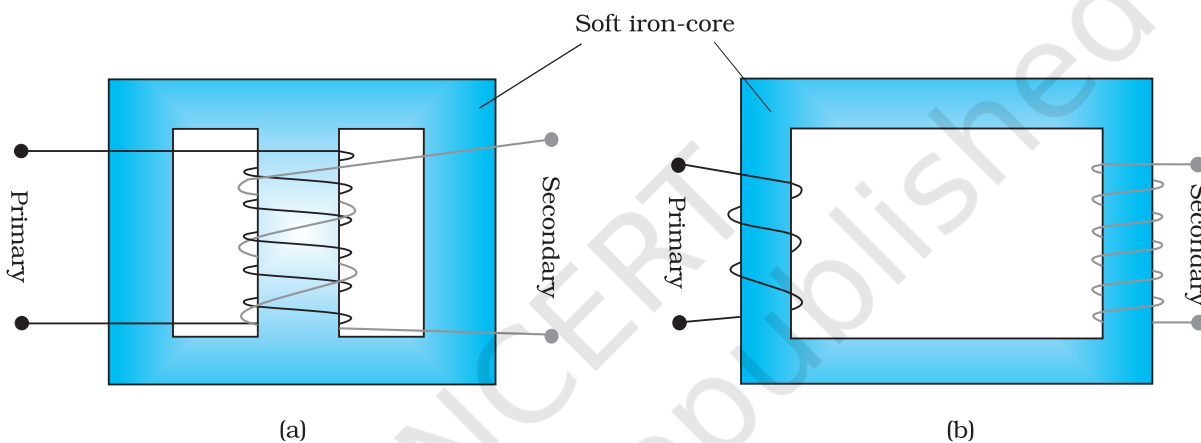

FIGURE 7.16 Two arrangements for winding of primary and secondary coil in a transformer: (a) two coils on top of each other, (b) two coils on separate limbs of the core.

When an alternating voltage is applied to the primary, the resulting current produces an alternating magnetic flux which links the secondary and induces an emf in it. The value of this emf depends on the number of turns in the secondary. We consider an ideal transformer in which the primary has negligible resistance and all the flux in the core links both primary and secondary windings. Let ϕ be the flux in each turn in the core at time t due to current in the primary when a voltage v_p is applied to it.

Then the induced emf or voltage ε_s , in the secondary with N_s turns is

$$\varepsilon_s = -N_s \frac{d\phi}{dt} \quad (7.31)$$

The alternating flux ϕ also induces an emf, called back emf in the primary. This is

$$\varepsilon_p = -N_p \frac{d\phi}{dt} \quad (7.32)$$

But $\varepsilon_p = v_p$. If this were not so, the primary current would be infinite since the primary has zero resistance (as assumed). If the secondary is an open circuit or the current taken from it is small, then to a good approximation

$$\varepsilon_s = v_s$$

where v_s is the voltage across the secondary. Therefore, Eqs. (7.31) and (7.32) can be written as

$$v_s = -N_s \frac{d\phi}{dt} \quad [7.31(a)]$$

$$v_p = -N_p \frac{d\phi}{dt} \quad [7.32(a)]$$

From Eqs. [7.31 (a)] and [7.32 (a)], we have

$$\frac{v_s}{v_p} = \frac{N_s}{N_p} \quad (7.33)$$

Note that the above relation has been obtained using three assumptions: (i) the primary resistance and current are small; (ii) the same flux links both the primary and the secondary as very little flux escapes from the core, and (iii) the secondary current is small.

If the transformer is assumed to be 100% efficient (no energy losses), the power input is equal to the power output, and since $p = i v$,

$$i_p v_p = i_s v_s \quad (7.34)$$

Although some energy is always lost, this is a good approximation, since a well designed transformer may have an efficiency of more than 95%. Combining Eqs. (7.33) and (7.34), we have

$$\frac{i_p}{i_s} = \frac{v_s}{v_p} = \frac{N_s}{N_p} \quad (7.35)$$

Since i and v both oscillate with the same frequency as the ac source, Eq. (7.35) also gives the ratio of the amplitudes or rms values of corresponding quantities.

Now, we can see how a transformer affects the voltage and current. We have:

$$V_s = \left(\frac{N_s}{N_p} \right) V_p \quad \text{and} \quad I_s = \left(\frac{N_p}{N_s} \right) I_p \quad (7.36)$$

That is, if the secondary coil has a greater number of turns than the primary ($N_s > N_p$), the voltage is stepped up ($V_s > V_p$). This type of arrangement is called a *step-up transformer*. However, in this arrangement, there is less current in the secondary than in the primary ($N_p/N_s < 1$ and $I_s < I_p$). For example, if the primary coil of a transformer has 100 turns and the secondary has 200 turns, $N_s/N_p = 2$ and $N_p/N_s = 1/2$. Thus, a 220V input at 10A will step-up to 440 V output at 5.0 A.

If the secondary coil has less turns than the primary ($N_s < N_p$), we have a *step-down transformer*. In this case, $V_s < V_p$ and $I_s > I_p$. That is, the voltage is stepped down, or reduced, and the current is increased.

The equations obtained above apply to ideal transformers (without any energy losses). But in actual transformers, small energy losses do occur due to the following reasons:

- (i) *Flux Leakage*: There is always some flux leakage; that is, not all of the flux due to primary passes through the secondary due to poor

design of the core or the air gaps in the core. It can be reduced by winding the primary and secondary coils one over the other.

- (ii) *Resistance of the windings*: The wire used for the windings has some resistance and so, energy is lost due to heat produced in the wire (I^2R). In high current, low voltage windings, these are minimised by using thick wire.
- (iii) *Eddy currents*: The alternating magnetic flux induces eddy currents in the iron core and causes heating. The effect is reduced by using a laminated core.
- (iv) *Hysteresis*: The magnetisation of the core is repeatedly reversed by the alternating magnetic field. The resulting expenditure of energy in the core appears as heat and is kept to a minimum by using a magnetic material which has a low hysteresis loss.

The large scale transmission and distribution of electrical energy over long distances is done with the use of transformers. The voltage output of the generator is stepped-up (so that current is reduced and consequently, the I^2R loss is cut down). It is then transmitted over long distances to an area sub-station near the consumers. There the voltage is stepped down. It is further stepped down at distributing sub-stations and utility poles before a power supply of 240 V reaches our homes.

SUMMARY

1. An alternating voltage $v = v_m \sin \omega t$ applied to a resistor R drives a current $i = i_m \sin \omega t$ in the resistor, $i_m = \frac{v_m}{R}$. The current is in phase with the applied voltage.
2. For an alternating current $i = i_m \sin \omega t$ passing through a resistor R , the average power loss P (averaged over a cycle) due to joule heating is $(1/2) i_m^2 R$. To express it in the same form as the dc power ($P = I^2 R$), a special value of current is used. It is called *root mean square (rms) current* and is denoted by I :

$$I = \frac{i_m}{\sqrt{2}} = 0.707 i_m$$

Similarly, the *rms voltage* is defined by

$$V = \frac{v_m}{\sqrt{2}} = 0.707 v_m$$

We have $P = IV = I^2 R$

3. An ac voltage $v = v_m \sin \omega t$ applied to a pure inductor L , drives a current in the inductor $i = i_m \sin (\omega t - \pi/2)$, where $i_m = v_m/X_L$. $X_L = \omega L$ is called *inductive reactance*. The current in the inductor lags the voltage by $\pi/2$. The average power supplied to an inductor over one complete cycle is zero.

4. An ac voltage $v = v_m \sin \omega t$ applied to a capacitor drives a current in the capacitor: $i = i_m \sin (\omega t + \pi/2)$. Here,

$$i_m = \frac{v_m}{X_C}, X_C = \frac{1}{\omega C} \text{ is called } \textit{capacitive reactance}.$$

The current through the capacitor is $\pi/2$ ahead of the applied voltage. As in the case of inductor, the average power supplied to a capacitor over one complete cycle is zero.

5. For a series RLC circuit driven by voltage $v = v_m \sin \omega t$, the current is given by $i = i_m \sin (\omega t + \phi)$

$$\text{where } i_m = \frac{v_m}{\sqrt{R^2 + (X_C - X_L)^2}}$$

$$\text{and } \phi = \tan^{-1} \frac{X_C - X_L}{R}$$

$$Z = \sqrt{R^2 + (X_C - X_L)^2} \text{ is called the } \textit{impedance} \text{ of the circuit.}$$

The average power loss over a complete cycle is given by

$$P = V I \cos \phi$$

The term $\cos \phi$ is called the *power factor*.

6. In a purely inductive or capacitive circuit, $\cos \phi = 0$ and no power is dissipated even though a current is flowing in the circuit. In such cases, current is referred to as a *wattless current*.
7. The phase relationship between current and voltage in an ac circuit can be shown conveniently by representing voltage and current by rotating vectors called *phasors*. A phasor is a vector which rotates about the origin with angular speed ω . The magnitude of a phasor represents the amplitude or peak value of the quantity (voltage or current) represented by the phasor.

The analysis of an ac circuit is facilitated by the use of a phasor diagram.

8. A transformer consists of an iron core on which are bound a primary coil of N_p turns and a secondary coil of N_s turns. If the primary coil is connected to an ac source, the primary and secondary voltages are related by

$$V_s = \left(\frac{N_s}{N_p} \right) V_p$$

and the currents are related by

$$I_s = \left(\frac{N_p}{N_s} \right) I_p$$

If the secondary coil has a greater number of turns than the primary, the voltage is stepped-up ($V_s > V_p$). This type of arrangement is called a *step-up transformer*. If the secondary coil has turns less than the primary, we have a *step-down transformer*.

Physical quantity	Symbol	Dimensions	Unit	Remarks
rms voltage	V	$[ML^2T^{-3}A^{-1}]$	V	$V = \frac{v_m}{\sqrt{2}}$, v_m is the amplitude of the ac voltage.
rms current	I	$[A]$	A	$I = \frac{i_m}{\sqrt{2}}$, i_m is the amplitude of the ac current.
Reactance: Inductive Capacitive	X_L X_C	$[ML^2T^{-3}A^{-2}]$ $[ML^2T^{-3}A^{-2}]$		$X_L = \omega L$ $X_C = 1/\omega C$
Impedance	Z	$[ML^2T^{-3}A^{-2}]$		Depends on elements present in the circuit.
Resonant frequency	ω_r or ω_0	$[T^{-1}]$	Hz	$\omega_0 = \frac{1}{\sqrt{LC}}$ for a series RLC circuit
Quality factor	Q	Dimensionless		$Q = \frac{\omega_0 L}{R} = \frac{1}{\omega_0 CR}$ for a series RLC circuit.
Power factor		Dimensionless		$= \cos\phi$, ϕ is the phase difference between voltage applied and current in the circuit.

POINTS TO PONDER

- When a value is given for ac voltage or current, it is ordinarily the rms value. The voltage across the terminals of an outlet in your room is normally 240 V. This refers to the rms value of the voltage. The amplitude of this voltage is

$$v_m = \sqrt{2}V = \sqrt{2}(240) = 340 \text{ V}$$

- The power rating of an element used in ac circuits refers to its average power rating.
- The power consumed in an ac circuit is never negative.
- Both alternating current and direct current are measured in amperes. But how is the ampere defined for an alternating current? It cannot be derived from the mutual attraction of two parallel wires carrying ac currents, as the dc ampere is derived. An ac current changes direction

with the source frequency and the attractive force would average to zero. Thus, the ac ampere must be defined in terms of some property that is independent of the direction of the current. Joule heating is such a property, and there is one ampere of *rms* value of alternating current in a circuit if the current produces the same average heating effect as one ampere of dc current would produce under the same conditions.

5. In an ac circuit, while adding voltages across different elements, one should take care of their phases properly. For example, if V_R and V_C are voltages across R and C , respectively in an RC circuit, then the total voltage across RC combination is $V_{RC} = \sqrt{V_R^2 + V_C^2}$ and not $V_R + V_C$ since V_C is $\pi/2$ out of phase of V_R .
6. Though in a phasor diagram, voltage and current are represented by vectors, these quantities are not really vectors themselves. They are scalar quantities. It so happens that the amplitudes and phases of harmonically varying scalars combine mathematically in the same way as do the projections of rotating vectors of corresponding magnitudes and directions. The 'rotating vectors' that represent harmonically varying scalar quantities are introduced only to provide us with a simple way of adding these quantities using a rule that we already know as the law of vector addition.
7. There are no power losses associated with pure capacitances and pure inductances in an ac circuit. The only element that dissipates energy in an ac circuit is the resistive element.
8. In a RLC circuit, resonance phenomenon occur when $X_L = X_C$ or $\omega_0 = \frac{1}{\sqrt{LC}}$. For resonance to occur, the presence of both L and C elements in the circuit is a must. With only one of these (L or C) elements, there is no possibility of voltage cancellation and hence, no resonance is possible.
9. The power factor in a RLC circuit is a measure of how close the circuit is to expending the maximum power.
10. In generators and motors, the roles of input and output are reversed. In a motor, electric energy is the input and mechanical energy is the output. In a generator, mechanical energy is the input and electric energy is the output. Both devices simply transform energy from one form to another.
11. A transformer (step-up) changes a low-voltage into a high-voltage. This does not violate the law of conservation of energy. The current is reduced by the same proportion.

EXERCISES

- 7.1** A $100\ \Omega$ resistor is connected to a $220\ \text{V}$, $50\ \text{Hz}$ ac supply.
 (a) What is the rms value of current in the circuit?
 (b) What is the net power consumed over a full cycle?
- 7.2** (a) The peak voltage of an ac supply is $300\ \text{V}$. What is the rms voltage?
 (b) The rms value of current in an ac circuit is $10\ \text{A}$. What is the peak current?
- 7.3** A $44\ \text{mH}$ inductor is connected to $220\ \text{V}$, $50\ \text{Hz}$ ac supply. Determine the rms value of the current in the circuit.
- 7.4** A $60\ \mu\text{F}$ capacitor is connected to a $110\ \text{V}$, $60\ \text{Hz}$ ac supply. Determine the rms value of the current in the circuit.
- 7.5** In Exercises 7.3 and 7.4, what is the net power absorbed by each circuit over a complete cycle. Explain your answer.
- 7.6** A charged $30\ \mu\text{F}$ capacitor is connected to a $27\ \text{mH}$ inductor. What is the angular frequency of free oscillations of the circuit?
- 7.7** A series *LCR* circuit with $R = 20\ \Omega$, $L = 1.5\ \text{H}$ and $C = 35\ \mu\text{F}$ is connected to a variable-frequency $200\ \text{V}$ ac supply. When the frequency of the supply equals the natural frequency of the circuit, what is the average power transferred to the circuit in one complete cycle?
- 7.8** Figure 7.17 shows a series *LCR* circuit connected to a variable frequency $230\ \text{V}$ source. $L = 5.0\ \text{H}$, $C = 80\ \mu\text{F}$, $R = 40\ \Omega$.

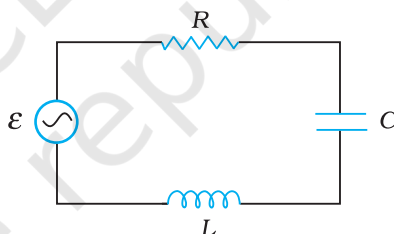
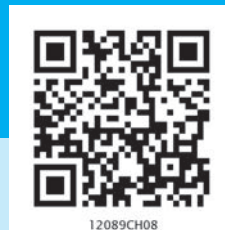

FIGURE 7.17

- (a) Determine the source frequency which drives the circuit in resonance.
- (b) Obtain the impedance of the circuit and the amplitude of current at the resonating frequency.
- (c) Determine the rms potential drops across the three elements of the circuit. Show that the potential drop across the *LC* combination is zero at the resonating frequency.



Chapter Eight

ELECTROMAGNETIC WAVES

8.1 INTRODUCTION

In Chapter 4, we learnt that an electric current produces magnetic field and that two current-carrying wires exert a magnetic force on each other. Further, in Chapter 6, we have seen that a magnetic field changing with time gives rise to an electric field. Is the converse also true? Does an electric field changing with time give rise to a magnetic field? James Clerk Maxwell (1831-1879), argued that this was indeed the case – not only an electric current but also a time-varying electric field generates magnetic field. While applying the Ampere’s circuital law to find magnetic field at a point outside a capacitor connected to a time-varying current, Maxwell noticed an inconsistency in the Ampere’s circuital law. He suggested the existence of an additional current, called by him, the displacement current to remove this inconsistency.

Maxwell formulated a set of equations involving electric and magnetic fields, and their sources, the charge and current densities. These equations are known as Maxwell’s equations. Together with the Lorentz force formula (Chapter 4), they mathematically express all the basic laws of electromagnetism.

The most important prediction to emerge from Maxwell’s equations is the existence of electromagnetic waves, which are (coupled) time-varying electric and magnetic fields that propagate in space. The speed of the waves, according to these equations, turned out to be very close to



James Clerk Maxwell (1831 – 1879) Born in Edinburgh, Scotland, was among the greatest physicists of the nineteenth century. He derived the thermal velocity distribution of molecules in a gas and was among the first to obtain reliable estimates of molecular parameters from measurable quantities like viscosity, etc. Maxwell's greatest achievement was the unification of the laws of electricity and magnetism (discovered by Coulomb, Oersted, Ampere and Faraday) into a consistent set of equations now called Maxwell's equations. From these he arrived at the most important conclusion that light is an electromagnetic wave. Interestingly, Maxwell did not agree with the idea (strongly suggested by the Faraday's laws of electrolysis) that electricity was particulate in nature.

JAMES CLERK MAXWELL (1831–1879)

the speed of light(3×10^8 m/s), obtained from optical measurements. This led to the remarkable conclusion that light is an electromagnetic wave. Maxwell's work thus unified the domain of electricity, magnetism and light. Hertz, in 1885, experimentally demonstrated the existence of electromagnetic waves. Its technological use by Marconi and others led in due course to the revolution in communication that we are witnessing today.

In this chapter, we first discuss the need for displacement current and its consequences. Then we present a descriptive account of electromagnetic waves. The broad spectrum of electromagnetic waves, stretching from γ rays (wavelength $\sim 10^{-12}$ m) to long radio waves (wavelength $\sim 10^6$ m) is described.

8.2 DISPLACEMENT CURRENT

We have seen in Chapter 4 that an electrical current produces a magnetic field around it. Maxwell showed that for logical consistency, a changing electric field *must also* produce a magnetic field. This effect is of great importance because it explains the existence of radio waves, gamma rays and visible light, as well as all other forms of electromagnetic waves.

To see how a changing electric field gives rise to a magnetic field, let us consider the process of charging of a capacitor and apply Ampere's circuital law given by (Chapter 4)

$$\oint \mathbf{B} \cdot d\mathbf{l} = \mu_0 i(t) \quad (8.1)$$

to find magnetic field at a point outside the capacitor. Figure 8.1(a) shows a parallel plate capacitor C which is a part of circuit through which a time-dependent current $i(t)$ flows. Let us find the magnetic field at a point such as P, in a region outside the parallel plate capacitor. For this, we consider a plane circular loop of radius r whose plane is perpendicular to the direction of the current-carrying wire, and which is centred symmetrically with respect to the wire [Fig. 8.1(a)]. From symmetry, the magnetic field is directed along the circumference of the circular loop and is the same in magnitude at all points on the loop so that if B is the magnitude of the field, the left side of Eq. (8.1) is $B(2\pi r)$. So we have

$$B(2\pi r) = \mu_0 i(t) \quad (8.2)$$

Now, consider a different surface, which has the same boundary. This is a pot like surface [Fig. 8.1(b)] which nowhere touches the current, but has its bottom between the capacitor plates; its mouth is the circular loop mentioned above. Another such surface is shaped like a tiffin box (without the lid) [Fig. 8.1(c)]. On applying Ampere's circuital law to such surfaces with the *same* perimeter, we find that the left hand side of Eq. (8.1) has not changed but the right hand side is *zero* and *not* $\mu_0 i$, since *no* current passes through the surface of Fig. 8.1(b) and (c). So we have a *contradiction*; calculated one way, there is a magnetic field at a point P; calculated another way, the magnetic field at P is zero.

Since the contradiction arises from our use of Ampere's circuital law, this law must be missing something. The missing term must be such that one gets the same magnetic field at point P, no matter what surface is used.

We can actually guess the missing term by looking carefully at Fig. 8.1(c). Is there anything passing through the surface S *between* the plates of the capacitor? Yes, of course, the electric field! If the plates of the capacitor have an area A, and a total charge Q, the magnitude of the electric field **E** between the plates is $(Q/A)/\epsilon_0$ (see Eq. 2.41). The field is perpendicular to the surface S of Fig. 8.1(c). It has the same magnitude over the area A of the capacitor plates, and vanishes outside it. So what is the *electric flux* ϕ_E through the surface S? Using Gauss's law, it is

$$\phi_E = |\mathbf{E}| A = \frac{1}{\epsilon_0} \frac{Q}{A} A = \frac{Q}{\epsilon_0} \quad (8.3)$$

Now if the charge Q on the capacitor plates changes with time, there is a current $i = (dQ/dt)$, so that using Eq. (8.3), we have

$$\frac{d\phi_E}{dt} = \frac{d}{dt} \left(\frac{Q}{\epsilon_0} \right) = \frac{1}{\epsilon_0} \frac{dQ}{dt}$$

This implies that for consistency,

$$\epsilon_0 \left(\frac{d\phi_E}{dt} \right) = i \quad (8.4)$$

This is the missing term in Ampere's circuital law. If we generalise this law by adding to the total current carried by conductors through the surface, another term which is ϵ_0 times the rate of change of electric flux through the same surface, the *total* has the same value of current i for all surfaces. If this is done, there is no contradiction in the value of B obtained anywhere using the generalised Ampere's law. B at the point P is non-zero no matter which surface is used for calculating it. B at a point P outside the plates [Fig. 8.1(a)] is the same as at a point M just inside, as it should be. The current carried by conductors due to flow of charges is called *conduction current*. The current, given by Eq. (8.4), is a new term, and is due to changing electric field (or electric *displacement*, an old term still used sometimes). It is, therefore, called *displacement current* or Maxwell's displacement current. Figure 8.2 shows the electric and magnetic fields inside the parallel plate capacitor discussed above.

The generalisation made by Maxwell then is the following. The source of a magnetic field is not *just* the conduction electric current due to flowing

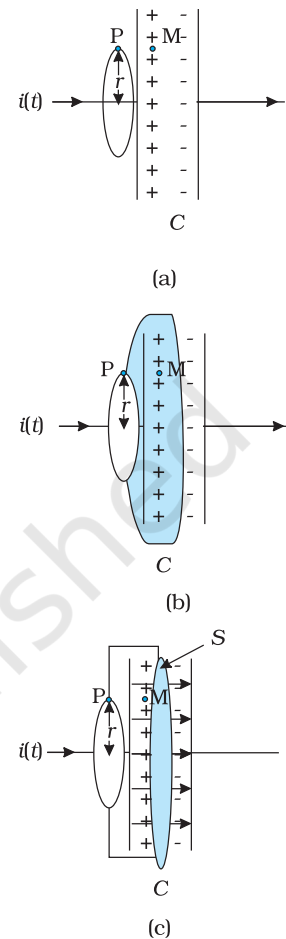

FIGURE 8.1 A parallel plate capacitor C, as part of a circuit through which a time dependent current $i(t)$ flows, (a) a loop of radius r , to determine magnetic field at a point P on the loop; (b) a pot-shaped surface passing through the interior between the capacitor plates with the loop shown in (a) as its rim; (c) a tiffin-shaped surface with the circular loop as its rim and a flat circular bottom S between the capacitor plates. The arrows show uniform electric field between the capacitor plates.

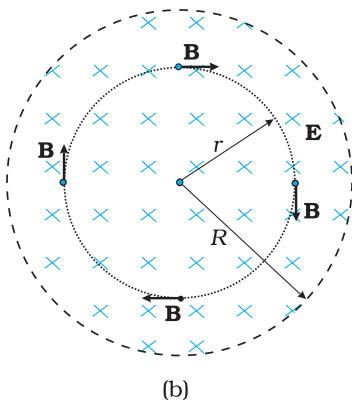
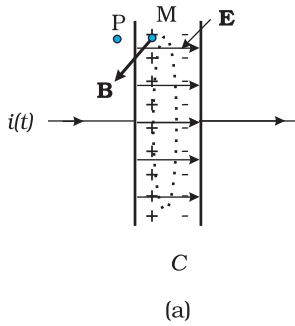

FIGURE 8.2 (a) The electric and magnetic fields \mathbf{E} and \mathbf{B} between the capacitor plates, at the point M. (b) A cross sectional view of Fig. (a).

charges, but also the time rate of change of electric field. More precisely, the total current i is the sum of the conduction current denoted by i_c , and the displacement current denoted by $i_d (= \epsilon_0 (d\Phi_E/dt))$. So we have

$$i = i_c + i_d = i_c + \epsilon_0 \frac{d\Phi_E}{dt} \quad (8.5)$$

In explicit terms, this means that outside the capacitor plates, we have only conduction current $i_c = i$, and no displacement current, i.e., $i_d = 0$. On the other hand, inside the capacitor, there is no conduction current, i.e., $i_c = 0$, and there is only displacement current, so that $i_d = i$.

The generalised (and correct) Ampere’s circuital law has the same form as Eq. (8.1), with one difference: “the *total current* passing through any surface of which the closed loop is the perimeter” is the sum of the conduction current and the displacement current. The generalised law is

$$\int \mathbf{B} \cdot d\mathbf{l} = \mu_0 i_c + \mu_0 \epsilon_0 \frac{d\Phi_E}{dt} \quad (8.6)$$

and is known as Ampere-Maxwell law.

In all respects, the displacement current has the same physical effects as the conduction current. In some cases, for example, steady electric fields in a conducting wire, the displacement current may be zero since the electric field \mathbf{E} does not change with time. In other cases, for example, the charging capacitor above, both conduction and displacement currents may be present in different regions of space. In most of the cases, they both may be present in the same region of space, as there exist no perfectly conducting or perfectly insulating medium. Most interestingly, there may be large regions of space where there is *no* conduction current, but there is only a displacement current due to time-varying electric fields. In such a region, we expect a magnetic field, though there is no (conduction) current source nearby! The prediction of such a displacement current can be verified experimentally. For example, a *magnetic field* (say at point M) between the plates of the capacitor in Fig. 8.2(a) can be measured and is seen to be the same as that just outside (at P).

The displacement current has (literally) far reaching consequences. One thing we immediately notice is that the laws of electricity and magnetism are now more symmetrical*. Faraday’s law of induction states that there is an induced emf *equal to the rate of change of magnetic flux*. Now, since the emf between two points 1 and 2 is the work done per unit charge in taking it from 1 to 2, the existence of an emf implies the existence of an electric field. So, we can rephrase Faraday’s law of electromagnetic induction by saying that a *magnetic field*, changing with time, gives rise to an *electric field*. Then, the fact that an *electric field* changing with time gives rise to a *magnetic field*, is the symmetrical counterpart, and is

* They are still not perfectly symmetrical; there are no known sources of magnetic field (magnetic monopoles) analogous to electric charges which are sources of electric field.

a consequence of the displacement current being a source of a magnetic field. Thus, time- dependent electric and magnetic fields give rise to each other! Faraday's law of electromagnetic induction and Ampere-Maxwell law give a quantitative expression of this statement, with the current being the total current, as in Eq. (8.5). One very important consequence of this symmetry is the existence of electromagnetic waves, which we discuss qualitatively in the next section.

MAXWELL'S EQUATIONS IN VACUUM

1. $\oint \mathbf{E} \cdot d\mathbf{A} = Q/\epsilon_0$ (Gauss's Law for electricity)
2. $\oint \mathbf{B} \cdot d\mathbf{A} = 0$ (Gauss's Law for magnetism)
3. $\oint \mathbf{E} \cdot d\mathbf{l} = \frac{-d\Phi_B}{dt}$ (Faraday's Law)
4. $\oint \mathbf{B} \cdot d\mathbf{l} = \mu_0 i_c + \mu_0 \epsilon_0 \frac{d\Phi_E}{dt}$ (Ampere – Maxwell Law)

8.3 ELECTROMAGNETIC WAVES

8.3.1 Sources of electromagnetic waves

How are electromagnetic waves produced? Neither stationary charges nor charges in uniform motion (steady currents) can be sources of electromagnetic waves. The former produces only electrostatic fields, while the latter produces magnetic fields that, however, do not vary with time. It is an important result of Maxwell's theory that accelerated charges radiate electromagnetic waves. The proof of this basic result is beyond the scope of this book, but we can accept it on the basis of rough, qualitative reasoning. Consider a charge oscillating with some frequency. (An oscillating charge is an example of accelerating charge.) This produces an oscillating electric field in space, which produces an oscillating magnetic field, which in turn, is a source of oscillating electric field, and so on. The oscillating electric and magnetic fields thus regenerate each other, so to speak, as the wave propagates through the space. The frequency of the electromagnetic wave naturally equals the frequency of oscillation of the charge. The energy associated with the propagating wave comes at the expense of the energy of the source – the accelerated charge.

From the preceding discussion, it might appear easy to test the prediction that light is an electromagnetic wave. We might think that all we needed to do was to set up an ac circuit in which the current oscillate at the frequency of visible light, say, yellow light. But, alas, that is not possible. The frequency of yellow light is about 6×10^{14} Hz, while the frequency that we get even with modern electronic circuits is hardly about 10^{11} Hz. This is why the experimental demonstration of electromagnetic



HEINRICH RUDOLF HERTZ (1857-1894)

Heinrich Rudolf Hertz (1857 - 1894) German physicist who was the first to broadcast and receive radio waves. He produced electromagnetic waves, sent them through space, and measured their wavelength and speed. He showed that the nature of their vibration, reflection and refraction was the same as that of light and heat waves, establishing their identity for the first time. He also pioneered research on discharge of electricity through gases, and discovered the photoelectric effect.

wave had to come in the low frequency region (the radio wave region), as in the Hertz's experiment (1887).

Hertz's successful experimental test of Maxwell's theory created a sensation and sparked off other important works in this field. Two important achievements in this connection deserve mention. Seven years after Hertz, Jagdish Chandra Bose, working at Calcutta (now Kolkata), succeeded in producing and observing electromagnetic waves of much shorter wavelength (25 mm to 5 mm). His experiment, like that of Hertz's, was confined to the laboratory.

At around the same time, Guglielmo Marconi in Italy followed Hertz's work and succeeded in transmitting electromagnetic waves over distances of many kilometres. Marconi's experiment marks the beginning of the field of communication using electromagnetic waves.

8.3.2 Nature of electromagnetic waves

It can be shown from Maxwell's equations that electric and magnetic fields in an electromagnetic wave are perpendicular to each other, and to the direction of propagation. It appears reasonable, say from our discussion of the displacement current. Consider Fig. 8.2. The electric field inside the plates of the capacitor is directed perpendicular to the plates. The magnetic field this gives rise to via the displacement current is along the perimeter of a circle parallel to the capacitor plates. So \mathbf{B} and \mathbf{E} are perpendicular in this case. This is a general feature.

In Fig. 8.3, we show a typical example of a plane electromagnetic wave propagating along the z direction (the fields are shown as a function of the z coordinate, at a given time t). The electric field E_x is along the x -axis, and varies sinusoidally with z , at a given time. The magnetic field B_y is along the y -axis, and again varies sinusoidally with z . The electric and magnetic fields E_x

and B_y are perpendicular to each other, and to the direction z of propagation. We can write E_x and B_y as follows:

$$E_x = E_0 \sin(kz - \omega t) \quad [8.7(a)]$$

$$B_y = B_0 \sin(kz - \omega t) \quad [8.7(b)]$$

Here k is related to the wave length λ of the wave by the usual equation

$$k = \frac{2\pi}{\lambda} \quad (8.8)$$

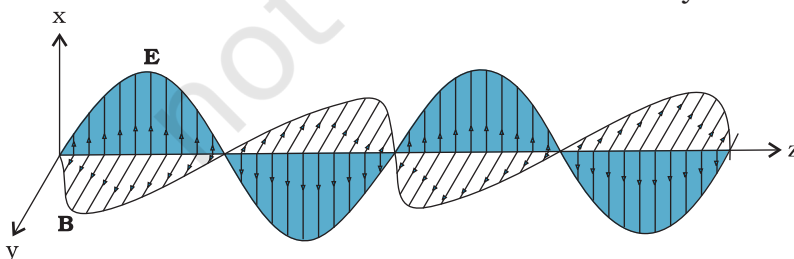

FIGURE 8.3 A linearly polarised electromagnetic wave, propagating in the z -direction with the oscillating electric field \mathbf{E} along the x -direction and the oscillating magnetic field \mathbf{B} along the y -direction.

and ω is the angular frequency. k is the magnitude of the wave vector (or propagation vector) \mathbf{k} and its direction describes the direction of propagation of the wave. The speed of propagation of the wave is (ω/k) . Using Eqs. [8.7(a) and (b)] for E_x and B_y and Maxwell's equations, one finds that

$$\omega = ck, \text{ where, } c = 1/\sqrt{\mu_0\epsilon_0} \quad [8.9(a)]$$

The relation $\omega = ck$ is the standard one for waves (see for example, Section 14.4 of class XI Physics textbook). This relation is often written in terms of frequency, $\nu (= \omega/2\pi)$ and wavelength, $\lambda (= 2\pi/k)$ as

$$2\pi\nu = c\left(\frac{2\pi}{\lambda}\right) \quad \text{or} \quad \nu\lambda = c \quad [8.9(b)]$$

It is also seen from Maxwell's equations that the magnitude of the electric and the magnetic fields in an electromagnetic wave are related as

$$B_0 = (E_0/c) \quad (8.10)$$

We here make remarks on some features of electromagnetic waves. They are self-sustaining oscillations of electric and magnetic fields in free space, or vacuum. They differ from all the other waves we have studied so far, in respect that *no material medium* is involved in the vibrations of the electric and magnetic fields.

But what if a material medium is actually there? We know that light, an electromagnetic wave, does propagate through glass, for example. We have seen earlier that the total electric and magnetic fields inside a medium are described in terms of a permittivity ϵ and a magnetic permeability μ (these describe the factors by which the total fields differ from the external fields). These replace ϵ_0 and μ_0 in the description to electric and magnetic fields in Maxwell's equations with the result that in a material medium of permittivity ϵ and magnetic permeability μ , the velocity of light becomes,

$$v = \frac{1}{\sqrt{\mu\epsilon}} \quad (8.11)$$

Thus, the velocity of light depends on electric and magnetic properties of the medium. We shall see in the next chapter that the *refractive index* of one medium with respect to the other is equal to the ratio of velocities of light in the two media.

The velocity of electromagnetic waves in free space or vacuum is an important fundamental constant. It has been shown by experiments on electromagnetic waves of different wavelengths that this velocity is the same (independent of wavelength) to within a few metres per second, out of a value of 3×10^8 m/s. The constancy of the velocity of em waves in vacuum is so strongly supported by experiments and the actual value is so well known now that this is used to define a standard of *length*.

The great technological importance of electromagnetic waves stems from their capability to carry energy from one place to another. The radio and TV signals from broadcasting stations carry energy. Light carries energy from the sun to the earth, thus making life possible on the earth.

EXAMPLE 8.1

Example 8.1 A plane electromagnetic wave of frequency 25 MHz travels in free space along the x -direction. At a particular point in space and time, $\mathbf{E} = 6.3 \hat{\mathbf{j}}$ V/m. What is \mathbf{B} at this point?

Solution Using Eq. (8.10), the magnitude of \mathbf{B} is

$$\begin{aligned}
 B &= \frac{E}{c} \\
 &= \frac{6.3 \text{ V/m}}{3 \times 10^8 \text{ m/s}} = 2.1 \times 10^{-8} \text{ T}
 \end{aligned}$$

To find the direction, we note that \mathbf{E} is along y -direction and the wave propagates along x -axis. Therefore, \mathbf{B} should be in a direction perpendicular to both x - and y -axes. Using vector algebra, $\mathbf{E} \times \mathbf{B}$ should be along x -direction. Since, $(+\hat{\mathbf{j}}) \times (+\hat{\mathbf{k}}) = \hat{\mathbf{i}}$, \mathbf{B} is along the z -direction. Thus, $\mathbf{B} = 2.1 \times 10^{-8} \hat{\mathbf{k}}$ T

EXAMPLE 8.2

Example 8.2 The magnetic field in a plane electromagnetic wave is given by $B_y = (2 \times 10^{-7}) \text{ T} \sin (0.5 \times 10^3 x + 1.5 \times 10^{11} t)$.

- What is the wavelength and frequency of the wave?
- Write an expression for the electric field.

Solution

- Comparing the given equation with

$$B_y = B_0 \sin \left[2\pi \left(\frac{x}{\lambda} + \frac{t}{T} \right) \right]$$

$$\text{We get, } \lambda = \frac{2\pi}{0.5 \times 10^3} \text{ m} = 1.26 \text{ cm,}$$

$$\text{and } \frac{1}{T} = \nu = (1.5 \times 10^{11}) / 2\pi = 23.9 \text{ GHz}$$

- $E_0 = B_0 c = 2 \times 10^{-7} \text{ T} \times 3 \times 10^8 \text{ m/s} = 6 \times 10^1 \text{ V/m}$

The electric field component is perpendicular to the direction of propagation and the direction of magnetic field. Therefore, the electric field component along the z -axis is obtained as

$$E_z = 60 \sin (0.5 \times 10^3 x + 1.5 \times 10^{11} t) \text{ V/m}$$

8.4 ELECTROMAGNETIC SPECTRUM

At the time Maxwell predicted the existence of electromagnetic waves, the only familiar electromagnetic waves were the visible light waves. The existence of ultraviolet and infrared waves was barely established. By the end of the nineteenth century, X-rays and gamma rays had also been discovered. We now know that, electromagnetic waves include visible light waves, X-rays, gamma rays, radio waves, microwaves, ultraviolet and infrared waves. The classification of em waves according to frequency is the electromagnetic spectrum (Fig. 8.4). *There is no sharp division between one kind of wave and the next.* The classification is based roughly on how the waves are produced and/or detected.

We briefly describe these different types of electromagnetic waves, in order of decreasing wavelengths.

Electromagnetic Waves

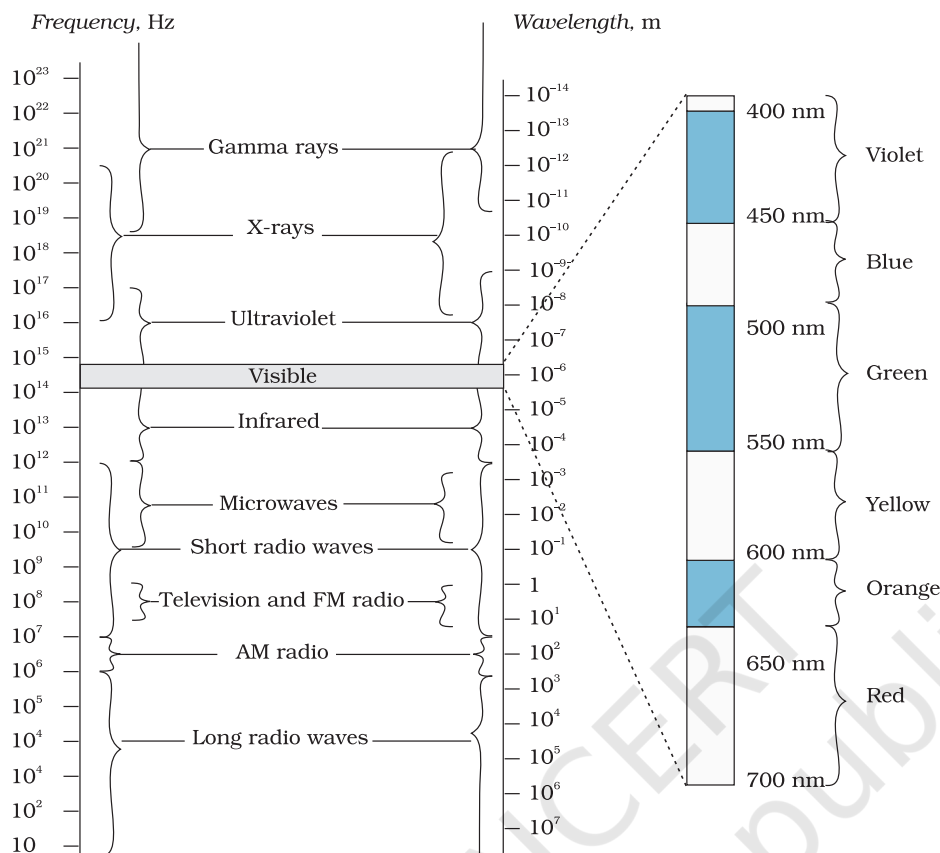

FIGURE 8.4 The electromagnetic spectrum, with common names for various part of it. The various regions do not have sharply defined boundaries.

8.4.1 Radio waves

Radio waves are produced by the accelerated motion of charges in conducting wires. They are used in radio and television communication systems. They are generally in the frequency range from 500 kHz to about 1000 MHz. The AM (amplitude modulated) band is from 530 kHz to 1710 kHz. Higher frequencies upto 54 MHz are used for *short wave* bands. TV waves range from 54 MHz to 890 MHz. The FM (frequency modulated) radio band extends from 88 MHz to 108 MHz. Cellular phones use radio waves to transmit voice communication in the ultrahigh frequency (UHF) band. How these waves are transmitted and received is described in Chapter 15.

8.4.2 Microwaves

Microwaves (short-wavelength radio waves), with frequencies in the gigahertz (GHz) range, are produced by special vacuum tubes (called klystrons, magnetrons and Gunn diodes). Due to their short wavelengths, they are suitable for the radar systems used in aircraft navigation. Radar also provides the basis for the speed guns used to time fast balls, tennis-serves, and automobiles. Microwave ovens are an interesting domestic application of these waves. In such ovens, the frequency of the microwaves is selected to match the resonant frequency of water molecules so that energy from the waves is transferred efficiently to the kinetic energy of the molecules. This raises the temperature of any food containing water.



8.4.3 Infrared waves

Infrared waves are produced by hot bodies and molecules. This band lies adjacent to the low-frequency or long-wave length end of the visible spectrum. Infrared waves are sometimes referred to as *heat waves*. This is because water molecules present in most materials readily absorb infrared waves (many other molecules, for example, CO_2 , NH_3 , also absorb infrared waves). After absorption, their thermal motion increases, that is, they heat up and heat their surroundings. Infrared lamps are used in physical therapy. Infrared radiation also plays an important role in maintaining the earth's warmth or average temperature through the greenhouse effect. Incoming visible light (which passes relatively easily through the atmosphere) is absorbed by the earth's surface and re-radiated as infrared (longer wavelength) radiations. This radiation is trapped by greenhouse gases such as carbon dioxide and water vapour. Infrared detectors are used in Earth satellites, both for military purposes and to observe growth of crops. Electronic devices (for example semiconductor light emitting diodes) also emit infrared and are widely used in the remote switches of household electronic systems such as TV sets, video recorders and hi-fi systems.

8.4.4 Visible rays

It is the most familiar form of electromagnetic waves. It is the part of the spectrum that is detected by the human eye. It runs from about 4×10^{14} Hz to about 7×10^{14} Hz or a wavelength range of about 700 – 400 nm. Visible light emitted or reflected from objects around us provides us information about the world. Our eyes are sensitive to this range of wavelengths. Different animals are sensitive to different range of wavelengths. For example, snakes can detect infrared waves, and the 'visible' range of many insects extends well into the ultraviolet.

8.4.5 Ultraviolet rays

It covers wavelengths ranging from about 4×10^{-7} m (400 nm) down to 6×10^{-10} m (0.6 nm). Ultraviolet (UV) radiation is produced by special lamps and very hot bodies. The sun is an important source of ultraviolet light. But fortunately, most of it is absorbed in the ozone layer in the atmosphere at an altitude of about 40 – 50 km. UV light in large quantities has harmful effects on humans. Exposure to UV radiation induces the production of more melanin, causing tanning of the skin. UV radiation is absorbed by ordinary glass. Hence, one cannot get tanned or sunburn through glass windows.

Welders wear special glass goggles or face masks with glass windows to protect their eyes from large amount of UV produced by welding arcs. Due to its shorter wavelengths, UV radiations can be focussed into very narrow beams for high precision applications such as LASIK (*Laser-assisted in situ keratomileusis*) eye surgery. UV lamps are used to kill germs in water purifiers.

Ozone layer in the atmosphere plays a protective role, and hence its depletion by chlorofluorocarbons (CFCs) gas (such as freon) is a matter of international concern.

8.4.6 X-rays

Beyond the UV region of the electromagnetic spectrum lies the X-ray region. We are familiar with X-rays because of its medical applications. It covers wavelengths from about 10^{-8} m (10 nm) down to 10^{-13} m (10^{-4} nm). One common way to generate X-rays is to bombard a metal target by high energy electrons. X-rays are used as a diagnostic tool in medicine and as a treatment for certain forms of cancer. Because X-rays damage or destroy living tissues and organisms, care must be taken to avoid unnecessary or over exposure.

8.4.7 Gamma rays

They lie in the upper frequency range of the electromagnetic spectrum and have wavelengths of from about 10^{-10} m to less than 10^{-14} m. This high frequency radiation is produced in nuclear reactions and also emitted by radioactive nuclei. They are used in medicine to destroy cancer cells.

Table 8.1 summarises different types of electromagnetic waves, their production and detections. As mentioned earlier, the demarcation between different regions is not sharp and there are overlaps.

TABLE 8.1 DIFFERENT TYPES OF ELECTROMAGNETIC WAVES

Type	Wavelength range	Production	Detection
Radio	> 0.1 m	Rapid acceleration and decelerations of electrons in aerials	Receiver's aerials
Microwave	0.1m to 1 mm	Klystron valve or magnetron valve	Point contact diodes
Infra-red	1mm to 700 nm	Vibration of atoms and molecules	Thermopiles Bolometer, Infrared photographic film
Light	700 nm to 400 nm	Electrons in atoms emit light when they move from one energy level to a lower energy level	The eye Photocells Photographic film
Ultraviolet	400 nm to 1nm	Inner shell electrons in atoms moving from one energy level to a lower level	Photocells Photographic film
X-rays	1nm to 10^{-3} nm	X-ray tubes or inner shell electrons	Photographic film Geiger tubes Ionisation chamber
Gamma rays	< 10^{-3} nm	Radioactive decay of the nucleus	-do-

SUMMARY

1. Maxwell found an inconsistency in the Ampere's law and suggested the existence of an additional current, called displacement current, to remove this inconsistency. This displacement current is due to time-varying electric field and is given by

$$i_d = \epsilon_0 \frac{d\Phi_E}{dt}$$

and acts as a source of magnetic field in exactly the same way as conduction current.

2. An accelerating charge produces electromagnetic waves. An electric charge oscillating harmonically with frequency ν , produces electromagnetic waves of the same frequency ν . An electric dipole is a basic source of electromagnetic waves.
3. Electromagnetic waves with wavelength of the order of a few metres were first produced and detected in the laboratory by Hertz in 1887. He thus verified a basic prediction of Maxwell's equations.
4. Electric and magnetic fields oscillate sinusoidally in space and time in an electromagnetic wave. The oscillating electric and magnetic fields, **E** and **B** are perpendicular to each other, and to the direction of propagation of the electromagnetic wave. For a wave of frequency ν , wavelength λ , propagating along z -direction, we have

$$\begin{aligned} E &= E_x(t) = E_0 \sin(kz - \omega t) \\ &= E_0 \sin \left[2\pi \left(\frac{z}{\lambda} - \nu t \right) \right] = E_0 \sin \left[2\pi \left(\frac{z}{\lambda} - \frac{t}{T} \right) \right] \\ B &= B_y(t) = B_0 \sin(kz - \omega t) \\ &= B_0 \sin \left[2\pi \left(\frac{z}{\lambda} - \nu t \right) \right] = B_0 \sin \left[2\pi \left(\frac{z}{\lambda} - \frac{t}{T} \right) \right] \end{aligned}$$

They are related by $E_0/B_0 = c$.

5. The speed c of electromagnetic wave in vacuum is related to μ_0 and ϵ_0 (the free space permeability and permittivity constants) as follows:

$c = 1/\sqrt{\mu_0 \epsilon_0}$. The value of c equals the speed of light obtained from optical measurements.

Light is an electromagnetic wave; c is, therefore, also the speed of light. Electromagnetic waves other than light also have the same velocity c in free space.

The speed of light, or of electromagnetic waves in a material medium is given by $v = 1/\sqrt{\mu \epsilon}$

where μ is the permeability of the medium and ϵ its permittivity.

6. The spectrum of electromagnetic waves stretches, in principle, over an infinite range of wavelengths. Different regions are known by different names; γ -rays, X-rays, ultraviolet rays, visible rays, infrared rays, microwaves and radio waves in order of increasing wavelength from 10^{-2} Å or 10^{-12} m to 10^6 m.

They interact with matter via their electric and magnetic fields which set in oscillation charges present in all matter. The detailed interaction and so the mechanism of absorption, scattering, etc., depend on the wavelength of the electromagnetic wave, and the nature of the atoms and molecules in the medium.

POINTS TO PONDER

1. The basic difference between various types of electromagnetic waves lies in their wavelengths or frequencies since all of them travel through vacuum with the same speed. Consequently, the waves differ considerably in their mode of interaction with matter.
2. Accelerated charged particles radiate electromagnetic waves. The wavelength of the electromagnetic wave is often correlated with the characteristic size of the system that radiates. Thus, gamma radiation, having wavelength of 10^{-14} m to 10^{-15} m, typically originate from an atomic nucleus. X-rays are emitted from heavy atoms. Radio waves are produced by accelerating electrons in a circuit. A transmitting antenna can most efficiently radiate waves having a wavelength of about the same size as the antenna. Visible radiation emitted by atoms is, however, much longer in wavelength than atomic size.
3. Infrared waves, with frequencies lower than those of visible light, vibrate not only the electrons, but entire atoms or molecules of a substance. This vibration increases the internal energy and consequently, the temperature of the substance. This is why infrared waves are often called *heat waves*.
4. The centre of sensitivity of our eyes coincides with the centre of the wavelength distribution of the sun. It is because humans have evolved with visions most sensitive to the strongest wavelengths from the sun.

EXERCISES

- 8.1** Figure 8.5 shows a capacitor made of two circular plates each of radius 12 cm, and separated by 5.0 cm. The capacitor is being charged by an external source (not shown in the figure). The charging current is constant and equal to 0.15A.
- (a) Calculate the capacitance and the rate of change of potential difference between the plates.
 - (b) Obtain the displacement current across the plates.
 - (c) Is Kirchoff's first rule (junction rule) valid at each plate of the capacitor? Explain.

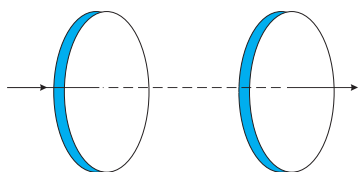

FIGURE 8.5

- 8.2** A parallel plate capacitor (Fig. 8.6) made of circular plates each of radius $R = 6.0$ cm has a capacitance $C = 100$ pF. The capacitor is connected to a 230 V ac supply with a (angular) frequency of 300 rad s^{-1} .

- (a) What is the rms value of the conduction current?
- (b) Is the conduction current equal to the displacement current?
- (c) Determine the amplitude of \mathbf{B} at a point 3.0 cm from the axis between the plates.

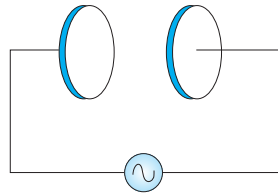

FIGURE 8.6

- 8.3 What physical quantity is the same for X-rays of wavelength 10^{-10} m, red light of wavelength 6800 Å and radiowaves of wavelength 500m?
- 8.4 A plane electromagnetic wave travels in vacuum along z-direction. What can you say about the directions of its electric and magnetic field vectors? If the frequency of the wave is 30 MHz, what is its wavelength?
- 8.5 A radio can tune in to any station in the 7.5 MHz to 12 MHz band. What is the corresponding wavelength band?
- 8.6 A charged particle oscillates about its mean equilibrium position with a frequency of 10^9 Hz. What is the frequency of the electromagnetic waves produced by the oscillator?
- 8.7 The amplitude of the magnetic field part of a harmonic electromagnetic wave in vacuum is $B_0 = 510$ nT. What is the amplitude of the electric field part of the wave?
- 8.8 Suppose that the electric field amplitude of an electromagnetic wave is $E_0 = 120$ N/C and that its frequency is $\nu = 50.0$ MHz. (a) Determine, $B_0, \omega, k,$ and λ . (b) Find expressions for \mathbf{E} and \mathbf{B} .
- 8.9 The terminology of different parts of the electromagnetic spectrum is given in the text. Use the formula $E = h\nu$ (for energy of a quantum of radiation: photon) and obtain the photon energy in units of eV for different parts of the electromagnetic spectrum. In what way are the different scales of photon energies that you obtain related to the sources of electromagnetic radiation?
- 8.10 In a plane electromagnetic wave, the electric field oscillates sinusoidally at a frequency of 2.0×10^{10} Hz and amplitude 48 V m $^{-1}$.
 - (a) What is the wavelength of the wave?
 - (b) What is the amplitude of the oscillating magnetic field?
 - (c) Show that the average energy density of the \mathbf{E} field equals the average energy density of the \mathbf{B} field. [$c = 3 \times 10^8$ m s $^{-1}$.]



LEPHIAN

ANSWERS

CHAPTER 1

- 1.1** 6×10^{-3} N (repulsive)
- 1.2** (a) 12 cm
(b) 0.2 N (attractive)
- 1.3** 2.4×10^{39} . This is the ratio of electric force to the gravitational force (at the same distance) between an electron and a proton.
- 1.5** Charge is not created or destroyed. It is merely transferred from one body to another.
- 1.6** Zero N
- 1.8** (a) 5.4×10^6 N C⁻¹ along OB
(b) 8.1×10^{-3} N along OA
- 1.9** Total charge is zero. Dipole moment = 7.5×10^{-8} C m along z-axis.
- 1.10** 10^{-4} N m
- 1.11** (a) 2×10^{12} , from wool to polythene.
(b) Yes, but of a negligible amount (= 2×10^{-18} kg in the example).
- 1.12** (a) 1.5×10^{-2} N
(b) 0.24 N
- 1.13** Charges 1 and 2 are negative, charge 3 is positive. Particle 3 has the highest charge to mass ratio.
- 1.14** (a) $30 \text{ Nm}^2/\text{C}$, (b) $15 \text{ Nm}^2/\text{C}$
- 1.15** Zero. The number of lines entering the cube is the same as the number of lines leaving the cube.
- 1.16** (a) $0.07 \mu\text{C}$
(b) No, only that the net charge inside is zero.
- 1.17** 2.2×10^5 N m²/C
- 1.18** 1.9×10^5 N m²/C
- 1.19** (a) -10^3 N m²/C; because the charge enclosed is the same in the two cases.
(b) -8.8 nC
- 1.20** -6.67 nC
- 1.21** (a) 1.45×10^{-3} C
(b) 1.6×10^8 Nm²/C
- 1.22** $10 \mu\text{C}/\text{m}$
- 1.23** (a) Zero, (b) Zero, (c) 1.9 N/C

CHAPTER 2

- 2.1 10 cm, 40 cm away from the positive charge on the side of the negative charge.
- 2.2 2.7×10^6 V
- 2.3 (a) The plane normal to AB and passing through its mid-point has zero potential everywhere.
(b) Normal to the plane in the direction AB.
- 2.4 (a) Zero
(b) 10^5 N C⁻¹
(c) 4.4×10^4 N C⁻¹
- 2.5 96 pF
- 2.6 (a) 3 pF
(b) 40 V
- 2.7 (a) 9 pF
(b) 2×10^{-10} C, 3×10^{-10} C, 4×10^{-10} C
- 2.8 18 pF, 1.8×10^{-9} C
- 2.9 (a) $V = 100$ V, $C = 108$ pF, $Q = 1.08 \times 10^{-8}$ C
(b) $Q = 1.8 \times 10^{-9}$ C, $C = 108$ pF, $V = 16.6$ V
- 2.10 1.5×10^{-8} J
- 2.11 6×10^{-6} J

CHAPTER 3

- 3.1 30 A
- 3.2 17 Ω, 8.5 V
- 3.3 1027 °C
- 3.4 2.0×10^{-7} Ωm
- 3.5 0.0039 °C⁻¹
- 3.6 867 °C
- 3.7 Current in branch AB = (4/17) A,
in BC = (6/17) A, in CD = (-4/17) A,
in AD = (6/17) A, in BD. = (-2/17) A, total current = (10/17) A.
- 3.8 11.5 V; the series resistor limits the current drawn from the external source. In its absence, the current will be dangerously high.
- 3.9 2.7×10^4 s (7.5 h)

CHAPTER 4

- 4.1 $\pi \times 10^{-4}$ T $\approx 3.1 \times 10^{-4}$ T
- 4.2 3.5×10^{-5} T

- 4.3 4×10^{-6} T, vertical up
 4.4 1.2×10^{-5} T, towards south
 4.5 0.6 N m^{-1}
 4.6 8.1×10^{-2} N; direction of force given by Fleming's left-hand rule
 4.7 2×10^{-5} N; attractive force normal to A towards B
 4.8 $8\pi \times 10^{-3} \text{ T} \approx 2.5 \times 10^{-2} \text{ T}$
 4.9 0.96 N m
 4.10 (a) 1.4, (b) 1
 4.11 4.2 cm
 4.12 18 MHz
 4.13 (a) 3.1 Nm, (b) No, the answer is unchanged because the formula $\tau = N I A \times B$ is true for a planar loop of any shape.

CHAPTER 5

- 5.1 0.36 JT^{-1}
 5.2 (a) \mathbf{m} parallel to \mathbf{B} ; $U = -mB = -4.8 \times 10^{-2} \text{ J}$; stable.
 (b) \mathbf{m} anti-parallel to \mathbf{B} ; $U = +mB = +4.8 \times 10^{-2} \text{ J}$; unstable.
 5.3 0.60 JT^{-1} along the axis of the solenoid determined by the sense of flow of the current.
 5.4 $7.5 \times 10^{-2} \text{ J}$
 5.5 (a) (i) 0.33 J (ii) 0.66 J
 (b) (i) Torque of magnitude 0.33 J in a direction that tends to align the magnitude moment vector along \mathbf{B} . (ii) Zero.
 5.6 (a) 1.28 A m^2 along the axis in the direction related to the sense of current via the right-handed screw rule.
 (b) Force is zero in uniform field; torque = 0.048 Nm in a direction that tends to align the axis of the solenoid (i.e., its magnetic moment vector) along \mathbf{B} .
 5.7 (a) 0.96 g along S-N direction.
 (b) 0.48 G along N-S direction.

CHAPTER 6

- 6.1 (a) Along qrpq
 (b) Along prq, along yzx
 (c) Along yzx
 (d) Along zyx
 (e) Along xry
 (f) No induced current since field lines lie in the plane of the loop.

- 6.2 (a) Along adcd (flux through the surface increases during shape change, so induced current produces opposing flux).
 (b) Along a'd'c'b' (flux decreases during the process)
- 6.3 $7.5 \times 10^{-6} \text{ V}$
- 6.4 (1) $2.4 \times 10^{-4} \text{ V}$, lasting 2 s
 (2) $0.6 \times 10^{-4} \text{ V}$, lasting 8 s
- 6.5 100 V
- 6.6 (a) $1.5 \times 10^{-3} \text{ V}$, (b) West to East, (c) Eastern end.
- 6.7 4H
- 6.8 30 Wb

CHAPTER 7

- 7.1 (a) 2.20 A
 (b) 484 W
- 7.2 (a) $\frac{300}{\sqrt{2}} = 212.1 \text{ V}$
 (b) $10\sqrt{2} = 14.1 \text{ A}$
- 7.3 15.9 A
- 7.4 2.49 A
- 7.5 Zero in each case.
- 7.6 $1.1 \times 10^3 \text{ s}^{-1}$
- 7.7 2,000 W
- 7.8 (a) 50 rad s^{-1}
 (b) 40Ω , 8.1 A
 (c) $V_{Lrms} = 1437.5 \text{ V}$, $V_{Crms} = 1437.5 \text{ V}$, $V_{Rrms} = 230 \text{ V}$

$$V_{LCrms} = I_{rms} \left(\omega_0 L - \frac{1}{\omega_0 C} \right) = 0$$

CHAPTER 8

- 8.1 (a) $C = \epsilon_0 A / d = 8.00 \text{ pF}$

$$\frac{dQ}{dt} = C \frac{dV}{dt}$$

$$\frac{dV}{dt} = \frac{0.15}{80.1 \times 10^{-12}} = 1.87 \times 10^9 \text{ V s}^{-1}$$

- (b) $i_d = \epsilon_0 \frac{d}{dt} \Phi_E$. Now across the capacitor $\Phi_E = EA$, ignoring end corrections.

$$\text{Therefore, } i_d = \epsilon_0 A \frac{d\Phi_E}{dt}$$

$$\text{Now, } E = \frac{Q}{\epsilon_0 A}. \text{ Therefore, } \frac{dE}{dt} = \frac{i}{\epsilon_0 A}, \text{ which implies } i_d = i = 0.15 \text{ A.}$$

- (c) Yes, provided by 'current' we mean the sum of conduction and displacement currents.

8.2 (a) $I_{\text{rms}} = V_{\text{rms}} \omega C = 6.9 \mu\text{A}$

- (b) Yes. The derivation in Exercise 8.1(b) is true even if i is oscillating in time.

(c) The formula $B = \frac{\mu_0}{2\pi} \frac{r}{R^2} i_d$

goes through even if i_d (and therefore B) oscillates in time. The formula shows they oscillate in phase. Since $i_d = i$, we have

$$B_0 = \frac{\mu_0}{2\pi} \frac{r}{R^2} i_0, \text{ where } B_0 \text{ and } i_0 \text{ are the amplitudes of the oscillating magnetic field and current, respectively. } i_0 = \sqrt{2} I_{\text{rms}} = 9.76 \mu\text{A. For } r = 3 \text{ cm, } R = 6 \text{ cm, } B_0 = 1.63 \times 10^{-11} \text{ T.}$$

8.3 The speed in vacuum is the same for all: $c = 3 \times 10^8 \text{ m s}^{-1}$.

8.4 \mathbf{E} and \mathbf{B} in x - y plane and are mutually perpendicular, 10 m.

8.5 Wavelength band: 40 m – 25 m.

8.6 10^9 Hz

8.7 153 N/C

8.8 (a) 400 nT, $3.14 \times 10^8 \text{ rad/s}$, 1.05 rad/m, 6.00 m.

(b) $\mathbf{E} = \{ (120 \text{ N/C}) \sin[(1.05 \text{ rad/m})x - (3.14 \times 10^8 \text{ rad/s})t] \} \hat{\mathbf{j}}$

$\mathbf{B} = \{ (400 \text{ nT}) \sin[(1.05 \text{ rad/m})x - (3.14 \times 10^8 \text{ rad/s})t] \} \hat{\mathbf{k}}$

8.9 Photon energy (for $\lambda = 1 \text{ m}$)

$$= \frac{6.63 \times 10^{-34} \times 3 \times 10^8}{1.6 \times 10^{-19}} \text{ eV} = 1.24 \times 10^{-6} \text{ eV}$$

Photon energy for other wavelengths in the figure for electromagnetic spectrum can be obtained by multiplying approximate powers of ten. Energy of a photon that a source produces indicates the spacings of the relevant energy levels of the source. For example, $\lambda = 10^{-12} \text{ m}$ corresponds to photon energy = $1.24 \times 10^6 \text{ eV} = 1.24 \text{ MeV}$. This indicates that nuclear energy levels (transition between which causes

γ -ray emission) are typically spaced by 1 MeV or so. Similarly, a visible wavelength $\lambda = 5 \times 10^{-7}$ m, corresponds to photon energy = 2.5 eV. This implies that energy levels (transition between which gives visible radiation) are typically spaced by a few eV.

- 8.10 (a) $\lambda = (c/\nu) = 1.5 \times 10^{-2}$ m
 (b) $B_0 = (E_0/c) = 1.6 \times 10^{-7}$ T
 (c) Energy density in **E** field: $u_E = (1/2)\epsilon_0 E^2$
 Energy density in **B** field: $u_B = (1/2\mu_0)B^2$

Using $E = cB$, and $c = \frac{1}{\sqrt{\mu_0\epsilon_0}}$, $u_E = u_B$

© NCERT
 not to be republished